

escha.net

ESCHA

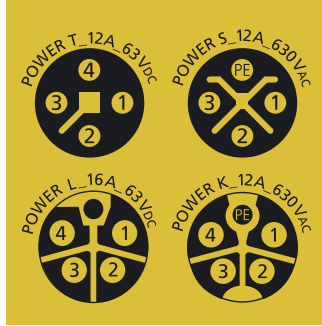

IP67

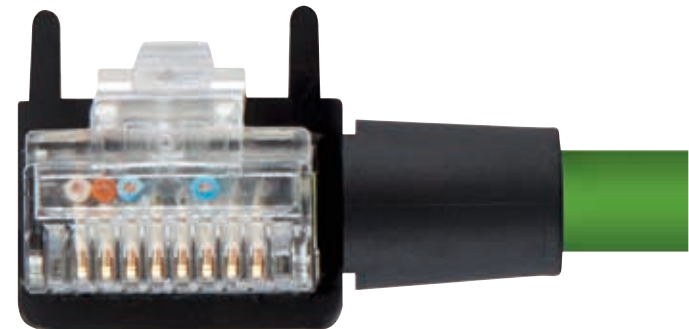
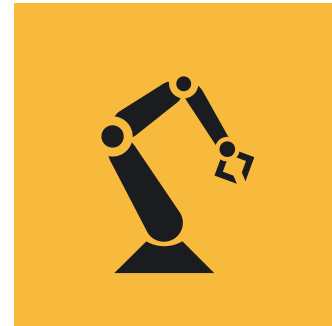
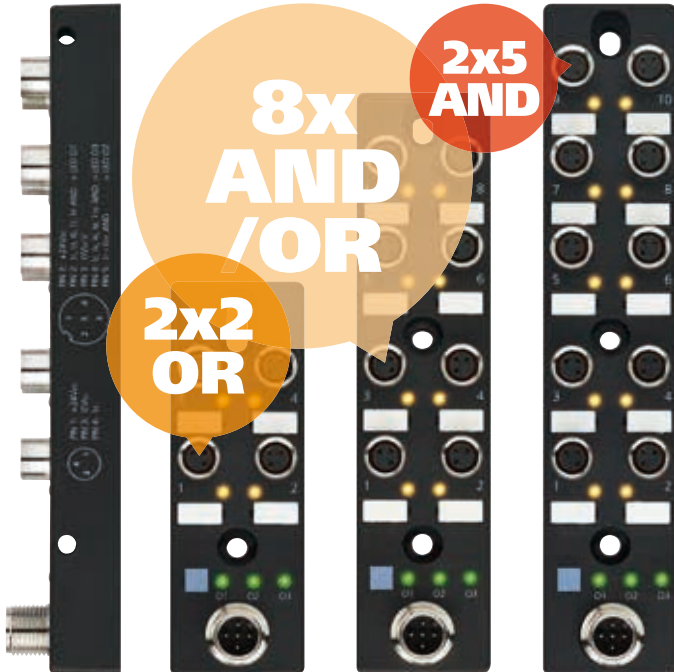
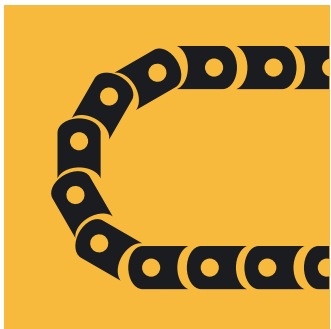



Vieles ist machbar

In vielen Applikationen führt Standard-Anschlusstechnik nicht zum Ziel. ESCHA bietet daher branchenspezifische Speziallösungen und kundenindividuelle Produkte. Von der Idee über Konstruktion, Werkzeugbau und Prüfmittel bis zur letztendlichen Serienproduktion erhalten Sie alles aus einer Hand.

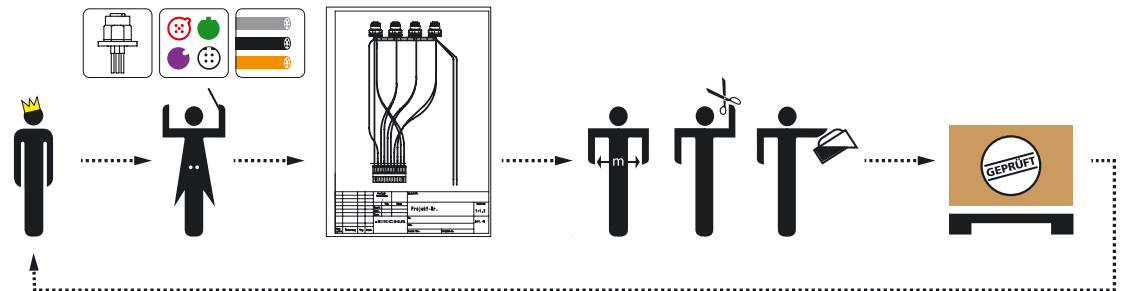

e d i t o r i a l

Mit dieser Ausgabe geht unser medienübergreifendes Katalogkonzept »ESCHA kmpkt« bereits in die dritte Generation. Um Ihre Anforderungen noch besser erfüllen zu können, haben wir wieder viele Ergänzungen in unserem Standardproduktprogramm vorgenommen.

Ab sofort bieten wir Ihnen eine umfangreiche Produktfamilie mit M8x1 I/O-Verteilern mit aktiver Logikfunktion an. Diese sind äußerst kompakt, platzieren Intelligenz nahe an Sensoren und übermitteln vorverarbeitete Signale an eine zentrale Steuerungseinheit. Für enge Schaltschränke haben wir platzsparende RJ45-Patchcords mit gewinkeltm Griffkörper entwickelt, die eine schnelle und zuverlässige Datenübertragung nach Cat5e ermöglichen. Abgeknickte oder gebrochene Leitungen gehören damit der Vergangenheit an.

Entdecken Sie darüber hinaus die vielen Möglichkeiten unseres eCatalogs. Gehen Sie auf escha.net, laden Sie sich den Katalog herunter und gelangen Sie mit einem Klick auf die Artikelnummer direkt zu den Detailinformationen Ihres Wunschartikels. Übrigens stellen wir Ihnen unsere Katalogdaten auch schnell und unkompliziert im weitverbreiteten Format BMEcat zur Verfügung. Daten von ESCHA erhalten Sie in den Klassifizierungssystemen eCl@ss und ETIM.

Falls Sie in diesem Katalog nicht das passende Produkt zu Ihrer Applikation finden sollten, dann kontaktieren Sie uns trotzdem. Denn wenn es um kundenspezifische Modifikationen oder gar individuelle Entwicklungen geht, dann ist ESCHA genau der richtige Ansprechpartner für Sie!

Wie immer freuen wir uns auf Ihr Feedback.
Ihr ESCHA Katalog-Team

kmpkt@escha.net



BL	base line	04
AL	Automation Line	10
FB	Food & Beverage	40
HT	Hochtemperaturfest	46
	Einbausteckverbinder Flansche	50
	Selbstkonfektionierbare Steckverbinder	62
IE	Industrial Ethernet	68
	RJ45 Patchcords	82
PB	Profibus	88
CD	CANopen/DeviceNet	94
P	M12x1 POWER	98
	2-fach Verteiler	106
	2-fach Verteiler mit Kabelabgang	114
IO	I/O-Verteiler Passiv	122
IO	I/O-Verteiler Logik	126
	M23x1	130
V	Ventilsteckverbinder	134
	Zubehör	142
	Leitungen	152
	100m-Ringe	154
	Technische Infos	158
	Kontaktbelegung	164

Nomenklatur Steckverbinder konfektioniert

Verbindungsleitung

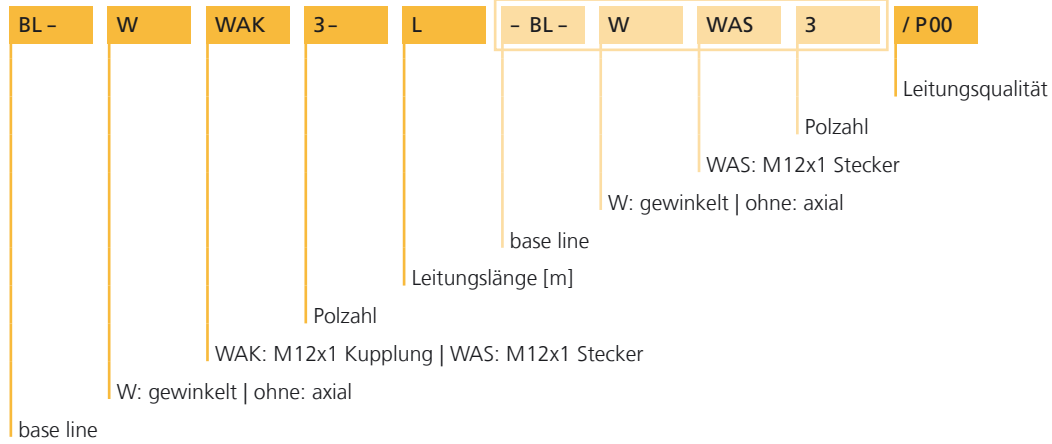

*nicht P00

Leitung	Kurzbeschreibung
P00 PVC	Flexible PVC/PVC Sensor-/Aktorsteuerleitung für mittlere mechanische Beanspruchungen. Bedingt öl- und chemikalienbeständig.
P01 PVC	Flexible PVC/PVC Sensor-/Aktorsteuerleitung für mittlere mechanische Beanspruchungen. Bedingt öl- und chemikalienbeständig, mit UL-Style.
S370 PUR	Flexible PUR/PP Sensor-/Aktorsteuerleitung für starke mechanische Beanspruchungen. Halogenfrei, flammwidrig, gute Torsions- und Schleppkettentauglichkeit, öl- und chemikalienbeständig, mit UL-Style.
S370GY PUR	Flexible PUR/PP Sensor-/Aktorsteuerleitung für starke mechanische Beanspruchungen. Halogenfrei, flammwidrig, gute Torsions- und Schleppkettentauglichkeit, öl- und chemikalienbeständig, mit UL-Style.
S400 PUR	Flexible PUR/PP Sensor-/Aktorsteuerleitung für starke mechanische Beanspruchungen. Halogenfrei, flammwidrig, gute Torsions- und Schleppkettentauglichkeit, öl- und chemikalienbeständig, mit UL-Style. Manuelle Abmantelbarkeit bis 1,50 Meter.





Abbildung im Maßstab ~ 1:1



base line

Technische Daten	M12x1
Isolationswiderstand	$\geq 10^8 \Omega$
Durchgangswiderstand	$\leq 5 m\Omega$
Umgebungstemperatur	-30°C...+90°C
Material Kontakte	Metall, CuSn, vergoldet
Material Kontaktträger	Kunststoff, TPU, BK
Material Griffkörper	Kunststoff, TPU, BK
Material Überwurf	Metall, CuZn, vernickelt
Material Dichtung (Kupplung)	FPM/FKM
Normen	IEC 61076-2-101
Schutzart (montiert)	IP65, IP67, IP68
Mechanische Lebensdauer	>100 Steckzyklen
Verschmutzungsgrad	3



M12x1-Steckverbinder für alle die ‚Standard‘ kaufen – nicht mehr und nicht weniger. base line Steckverbinder sind optimiert in Design, Produkteigenschaften, Herstellprozess und Preis. Sie sind erhältlich in 3-, 4- und 5-poligen Ausführungen sowie mit unterschiedlichen Leitungsqualitäten (PVC oder PUR). UL-zugelassene Materialien und Leitungsqualitäten ermöglichen den Einsatz im nordamerikanischen Raum. IP65, IP67 und IP68- Anforderungen werden selbstverständlich erfüllt.

		Kopf				Leitung			Artikelbezeichnung	L = Leitungslänge*		
		Pol	U[max]	I[max]	Extra	Material	Farbe	UL		2m / 1m	5m / 2m	10m / 5m
	Anschlussleitung Kupplung, M12x1, axial	3	250V	4A		PUR	BK	•	BL-WAK3-L/S370	8047935	8047871	8048461
				4A		PUR	BK	•	BL-WAK3-L/S400	8075580	8075581	8075582
				4A		PUR	GY	•	BL-WAK3-L/S370GY	8058625	8058626	8058627
				4A		PVC	GY		BL-WAK3-L/P00	8048554	8047903	8048483
				4A		PVC	GY	•	BL-WAK3-L/P01	8050937	8050938	8050939
		4	250V	4A		PUR	BK	•	BL-WAK4-L/S370	8048462	8047872	8048463
				4A		PUR	BK	•	BL-WAK4-L/S400	8075592	8075593	8075594
				4A		PUR	GY	•	BL-WAK4-L/S370GY	8058718	8058719	8058720
				4A		PVC	GY		BL-WAK4-L/P00	8048555	8047904	8048484
				4A		PVC	GY	•	BL-WAK4-L/P01	8050941	8050940	8050942
		5	60V	4A		PUR	BK	•	BL-WAK4.5-L/S370	8048467	8047874	8048468
				4A		PUR	BK	•	BL-WAK4.5-L/S400	8075604	8075605	8075606
				4A		PVC	GY		BL-WAK4.5-L/P00	8048742	8047906	8048743
				4A		PVC	GY	•	BL-WAK4.5-L/P01	8050946	8050947	8050948
			Anschlussleitung Kupplung, M12x1, gewinkelt	3	250V	4A		PUR	BK	•	BL-WWAK3-L/S370	8050702
4A						PUR	BK	•	BL-WWAK3-L/S400	8075586	8075587	8075588
4A						PUR	GY	•	BL-WWAK3-L/S370GY	8058739	8058740	8058741
4A						PVC	GY		BL-WWAK3-L/P00	8050793	8047908	8050794
4A						PVC	GY	•	BL-WWAK3-L/P01	8050952	8050953	8050954
4	250V			4A		PUR	BK	•	BL-WWAK4-L/S370	8050704	8047877	8050537
				4A		PUR	BK	•	BL-WWAK4-L/S400	8075598	8075599	8075600
				4A		PUR	GY	•	BL-WWAK4-L/S370GY	8058742	8058743	8058744
				4A		PVC	GY		BL-WWAK4-L/P00	8050298	8047909	8050536
				4A		PVC	GY	•	BL-WWAK4-L/P01	8050955	8050956	8050957
5	60V			4A		PUR	BK	•	BL-WWAK4.5-L/S370	8050709	8047879	8050710
				4A		PUR	BK	•	BL-WWAK4.5-L/S400	8075610	8075611	8075612
				4A		PVC	GY		BL-WWAK4.5-L/P00	8050799	8047911	8050803
				4A		PVC	GY	•	BL-WWAK4.5-L/P01	8050961	8050962	8050963

* Unsere Standardleitungslängen sind 2m, 5m oder 10m für Anschlussleitungen und 1m, 2m oder 5m für Verbindungsleitungen. Die Litzenlänge bei Flanschen beträgt 0,5m (POWER 0,2m). Alle anderen Leitungs- und Litzenlängen liefern wir Ihnen gern auf Anfrage.

		Kopf				Leitung			Artikelbezeichnung	L = Leitungslänge*		
		Pol	U[max]	I[max]	Extra	Material	Farbe	UL		2m / 1m	5m / 2m	10m / 5m
	Anschlussleitung Stecker, M12x1, axial	3	250V	4A	PUR	BK	•	BL-WAS3-L/S370	8048464	8047881	8048465	
				4A	PUR	BK	•	BL-WAS3-L/S400	8075583	8075584	8075585	
				4A	PUR	GY	•	BL-WAS3-L/S370GY	8058745	8058785	8058786	
				4A	PVC	GY		BL-WAS3-L/P00	8050815	8047913	8050818	
				4A	PVC	GY	•	BL-WAS3-L/P01	8050931	8050932	8050933	
		4	250V	4A	PUR	BK	•	BL-WAS4-L/S370	8048173	8047882	8048466	
				4A	PUR	BK	•	BL-WAS4-L/S400	8075595	8075596	8075597	
				4A	PUR	GY	•	BL-WAS4-L/S370GY	8058748	8058749	8058750	
				4A	PVC	GY		BL-WAS4-L/P00	8050821	8047914	8050823	
				4A	PVC	GY	•	BL-WAS4-L/P01	8050934	8050935	8050936	
		5	60V	4A	PUR	BK	•	BL-WAS4.5-L/S370	8048469	8047884	8048470	
				4A	PUR	BK	•	BL-WAS4.5-L/S400	8075607	8075608	8075609	
				4A	PVC	GY		BL-WAS4.5-L/P00	8050311	8047916	8050831	
				4A	PVC	GY	•	BL-WAS4.5-L/P01	8050970	8050971	8050972	
			Anschlussleitung Stecker, M12x1, gewinkelt	3	250V	4A	PUR	BK	•	BL-WWAS3-L/S370	8050717	8047886
4A	PUR					BK	•	BL-WWAS3-L/S400	8075589	8075590	8075591	
4A	PUR					GY	•	BL-WWAS3-L/S370GY	8058751	8058752	8058753	
4A	PVC					GY		BL-WWAS3-L/P00	8050837	8047918	8050839	
4A	PVC					GY	•	BL-WWAS3-L/P01	8050976	8050977	8050978	
4	250V			4A	PUR	BK	•	BL-WWAS4-L/S370	8050719	8047887	8050720	
				4A	PUR	BK	•	BL-WWAS4-L/S400	8075601	8075602	8075603	
				4A	PUR	GY	•	BL-WWAS4-L/S370GY	8058754	8058755	8058756	
				4A	PVC	GY		BL-WWAS4-L/P00	8050297	8047919	8050840	
				4A	PVC	GY	•	BL-WWAS4-L/P01	8050979	8050980	8050981	
5	60V			4A	PUR	BK	•	BL-WWAS4.5-L/S370	8050723	8047889	8050724	
				4A	PUR	BK	•	BL-WWAS4.5-L/S400	8075613	8075614	8075615	
				4A	PVC	GY		BL-WWAS4.5-L/P00	8050864	8047921	8050867	
				4A	PVC	GY	•	BL-WWAS4.5-L/P01	8050985	8050986	8050987	

* Unsere Standardleitungslängen sind 2m, 5m oder 10m für Anschlussleitungen und 1m, 2m oder 5m für Verbindungsleitungen. Die Litzenlänge bei Flanschen beträgt 0,5m (POWER 0,2m). Alle anderen Leitungs- und Litzenlängen liefern wir Ihnen gern auf Anfrage.

		Kopf				Leitung			Artikelbezeichnung	L = Leitungslänge*		
		Pol	U[max]	I[max]	Extra	Material	Farbe	UL		2m / 1m	5m / 2m	10m / 5m
	Verbindungsleitung Kupplung, M12x1, axial Stecker, M12x1, axial	3	250V	4A		PUR	BK	•	BL-WAK3-L-BL-WAS3/S370	8052002	8047937	8047798
				4A		PUR	GY	•	BL-WAK3-L-BL-WAS3/S370GY	8058721	8058722	8058723
				4A		PVC	GY		BL-WAK3-L-BL-WAS3/P00	8052016	8050870	8047923
				4A		PVC	GY	•	BL-WAK3-L-BL-WAS3/P01	8052030	8050992	8050993
		4	250V	4A		PUR	BK	•	BL-WAK4-L-BL-WAS4/S370	8052003	8050728	8047892
				4A		PUR	GY	•	BL-WAK4-L-BL-WAS4/S370GY	8058757	8058758	8058759
				4A		PVC	GY		BL-WAK4-L-BL-WAS4/P00	8052017	8050871	8047924
				4A		PVC	GY	•	BL-WAK4-L-BL-WAS4/P01	8052031	8050995	8050996
		5	60V	4A		PUR	BK	•	BL-WAK4.5-L-BL-WAS4.5/S370	8052005	8050136	8047893
				4A		PVC	GY		BL-WAK4.5-L-BL-WAS4.5/P00	8052018	8048906	8047925
				4A		PVC	GY	•	BL-WAK4.5-L-BL-WAS4.5/P01	8052033	8050998	8050999
			Verbindungsleitung Kupplung, M12x1, axial Stecker, M12x1, gewinkelt	3	250V	4A		PUR	BK	•	BL-WAK3-L-BL-WWAS3/S370	8052009
4A						PUR	GY	•	BL-WAK3-L-BL-WWAS3/S370GY	8058760	8058761	8058762
4A						PVC	GY		BL-WAK3-L-BL-WWAS3/P00	8052022	8050892	8047929
4A						PVC	GY	•	BL-WAK3-L-BL-WWAS3/P01	8052038	8051010	8051011
4	250V			4A		PUR	BK	•	BL-WAK4-L-BL-WWAS4/S370	8052010	8050738	8047898
				4A		PUR	GY	•	BL-WAK4-L-BL-WWAS4/S370GY	8058763	8058764	8058765
				4A		PVC	GY		BL-WAK4-L-BL-WWAS4/P00	8052023	8050894	8047930
				4A		PVC	GY	•	BL-WAK4-L-BL-WWAS4/P01	8052039	8051013	8051014
5	60V			4A		PUR	BK	•	BL-WAK4.5-L-BL-WWAS4.5/S370	8052011	8050740	8047899
				4A		PVC	GY		BL-WAK4.5-L-BL-WWAS4.5/P00	8052024	8050896	8047931
				4A		PVC	GY	•	BL-WAK4.5-L-BL-WWAS4.5/P01	8052040	8051016	8051017
	Verbindungsleitung Kupplung, M12x1, gewinkelt Stecker, M12x1, axial			3	250V	4A		PUR	BK	•	BL-WWAK3-L-BL-WAS3/S370	8052012
		4A				PUR	GY	•	BL-WWAK3-L-BL-WAS3/S370GY	8058766	8058813	8058814
		4A				PVC	GY		BL-WWAK3-L-BL-WAS3/P00	8052025	8047957	8047932
		4A				PVC	GY	•	BL-WWAK3-L-BL-WAS3/P01	8052041	8051019	8051020
		4	250V	4A		PUR	BK	•	BL-WWAK4-L-BL-WAS4/S370	8052013	8050744	8047901
				4A		PUR	GY	•	BL-WWAK4-L-BL-WAS4/S370GY	8058767	8058768	8058769
				4A		PVC	GY		BL-WWAK4-L-BL-WAS4/P00	8052026	8050903	8047933
				4A		PVC	GY	•	BL-WWAK4-L-BL-WAS4/P01	8052042	8051022	8051023
		5	60V	4A		PUR	BK	•	BL-WWAK4.5-L-BL-WAS4.5/S370	8052014	8050746	8047902
				4A		PVC	GY		BL-WWAK4.5-L-BL-WAS4.5/P00	8052029	8050911	8047934
				4A		PVC	GY	•	BL-WWAK4.5-L-BL-WAS4.5/P01	8052043	8051025	8051026

* Unsere Standardleitungslängen sind 2m, 5m oder 10m für Anschlussleitungen und 1m, 2m oder 5m für Verbindungsleitungen. Die Litzenlänge bei Flanschen beträgt 0,5m (POWER 0,2m). Alle anderen Leitungs- und Litzenlängen liefern wir Ihnen gern auf Anfrage.

		Kopf				Leitung			UL	Artikelbezeichnung	L = Leitungslänge*		
		Pol	U[max]	I[max]	Extra	Material	Farbe	2m / 1m			5m / 2m	10m / 5m	
	Verbindungsleitung Kupplung, M12x1, gewinkelt Stecker, M12x1, gewinkelt	3	250V	4A		PUR	BK	•	BL-WWAK3-L-BL-WWAS3/S370	8052006	8050730	8047894	
				4A		PUR	GY	•	BL-WWAK3-L-BL-WWAS3/S370GY	8058770	8058771	8058772	
				4A		PVC	GY		BL-WWAK3-L-BL-WWAS3/P00	8052019	8050886	8047926	
				4A		PVC	GY	•	BL-WWAK3-L-BL-WWAS3/P01	8052034	8051001	8051002	
		4	250V	4A		PUR	BK	•	BL-WWAK4-L-BL-WWAS4/S370	8052007	8050732	8047895	
				4A		PUR	GY	•	BL-WWAK4-L-BL-WWAS4/S370GY	8058773	8058774	8058775	
				4A		PVC	GY		BL-WWAK4-L-BL-WWAS4/P00	8052020	8050888	8047927	
				4A		PVC	GY	•	BL-WWAK4-L-BL-WWAS4/P01	8052035	8051004	8051005	
		5	60V	4A		PUR	BK	•	BL-WWAK4.5-L-BL-WWAS4.5/S370	8052008	8050734	8047896	
				4A		PVC	GY		BL-WWAK4.5-L-BL-WWAS4.5/P00	8052021	8050890	8047928	
				4A		PVC	GY	•	BL-WWAK4.5-L-BL-WWAS4.5/P01	8052036	8051007	8051008	

* Unsere Standardleitungslängen sind 2m, 5m oder 10m für Anschlussleitungen und 1m, 2m oder 5m für Verbindungsleitungen. Die Litzenlänge bei Flanschen beträgt 0,5m (POWER 0,2m). Alle anderen Leitungs- und Litzenlängen liefern wir Ihnen gern auf Anfrage.

Nomenklatur Steckverbinder konfektioniert

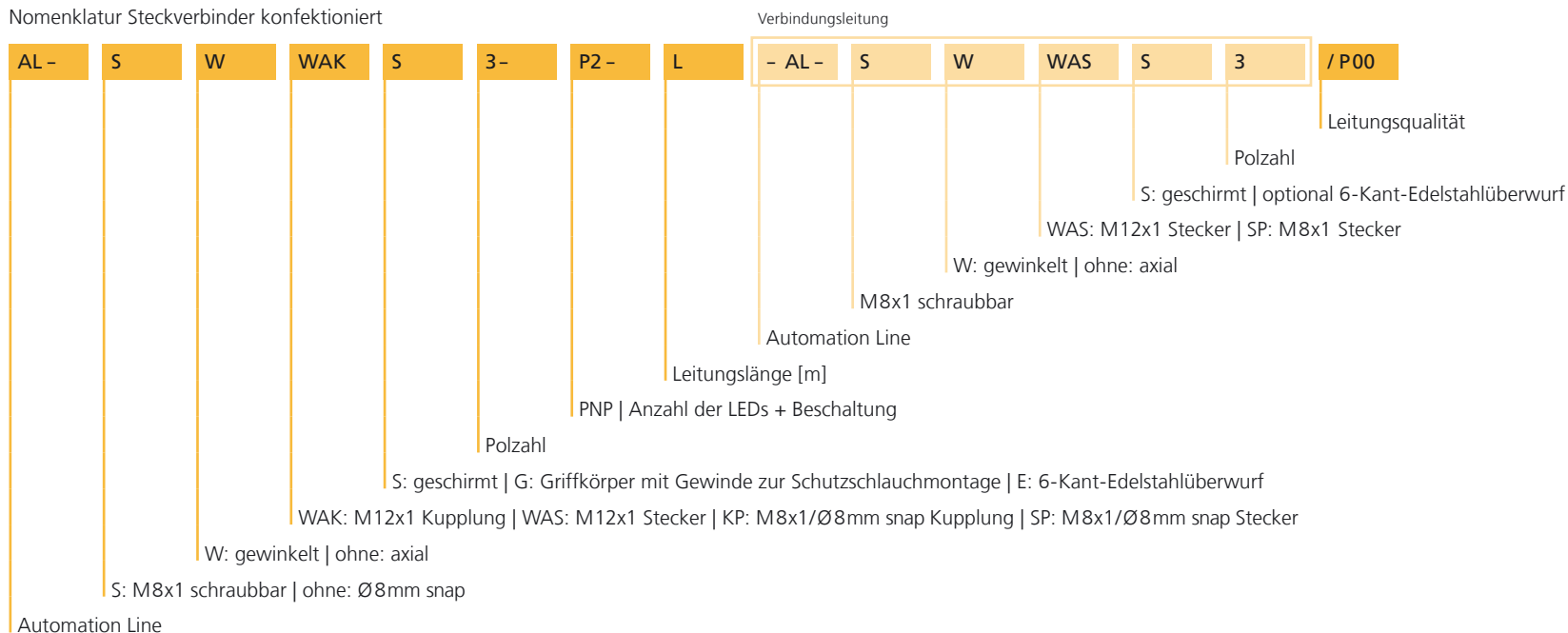

*nicht P00, M12x1_12pol, M8x1_5pol, Ø8mm snap

Leitung	Kurzbeschreibung
P00 PVC	Flexible PVC/PVC Sensor-/Aktorsteuerleitung für mittlere mechanische Beanspruchungen. Bedingt öl- und chemikalienbeständig.
P01 PVC	Flexible PVC/PVC Sensor-/Aktorsteuerleitung für mittlere mechanische Beanspruchungen. Bedingt öl- und chemikalienbeständig, mit UL-Style.
P01BK PVC	Flexible PVC/PVC Sensor-/Aktorsteuerleitung für mittlere mechanische Beanspruchungen. Bedingt öl- und chemikalienbeständig, mit UL-Style.
S370 PUR	Flexible PUR/PP Sensor-/Aktorsteuerleitung für starke mechanische Beanspruchungen. Halogenfrei, flammwidrig, gute Torsions- und Schleppkettentauglichkeit, öl- und chemikalienbeständig, mit UL-Style.
S370GY PUR	Flexible PUR/PP Sensor-/Aktorsteuerleitung für starke mechanische Beanspruchungen. Halogenfrei, flammwidrig, gute Torsions- und Schleppkettentauglichkeit, öl- und chemikalienbeständig, mit UL-Style.
S7400 PUR	Flexible PUR/PP Sensor-/Aktorsteuerleitung für starke mechanische Beanspruchungen. Halogenfrei, flammwidrig, sehr gute Torsions- und Schleppkettentauglichkeit, öl- und chemikalienbeständig, mit UL-Style.
S400 PUR	Flexible PUR/PP Sensor-/Aktorsteuerleitung für starke mechanische Beanspruchungen. Halogenfrei, flammwidrig, gute Torsions- und Schleppkettentauglichkeit, öl- und chemikalienbeständig, mit UL-Style. Manuelle Abmantelbarkeit bis 1,50 Meter.







Abbildung im Maßstab ~ 1:1

M12x1	Anschlussleitung, Kupplung	12
	Anschlussleitung, Stecker	16
	Verbindungsleitung	19
	Anschlussleitung, Kupplung, geschirmt	25
	Anschlussleitung, Stecker, geschirmt	26
	Verbindungsleitung, geschirmt	27
M8x1	Anschlussleitung, Kupplung	29
	Anschlussleitung, Stecker	30
	Verbindungsleitung	31
	Anschlussleitung, Kupplung, geschirmt	33
	Anschlussleitung, Stecker, geschirmt	34
	Verbindungsleitung, geschirmt	34
Ø8mm snap	Anschlussleitung, Kupplung	36
	Anschlussleitung, Stecker	38
	Verbindungsleitung	39

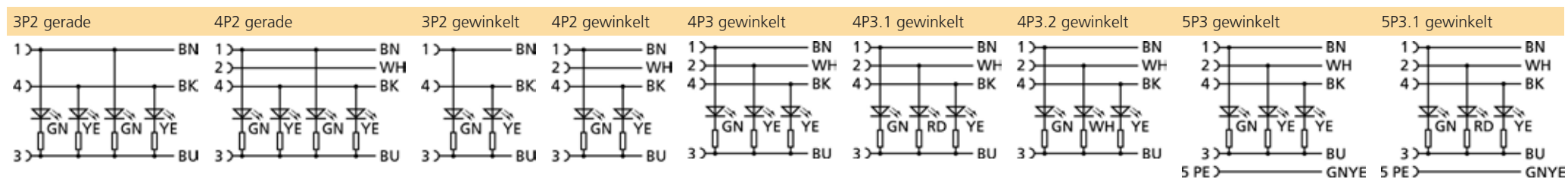

Automation Line

Technische Daten	M12x1	M8x1	Ø8mm snap
Isolationswiderstand	$\geq 10^8 \Omega$	$\geq 10^8 \Omega$	$\geq 10^8 \Omega$
Durchgangswiderstand	$\leq 5 m\Omega$	$\leq 5 m\Omega$	$\leq 5 m\Omega$
Umgebungstemperatur	-30°C...+90°C	-30°C...+90°C	-30°C...+90°C
Material Kontakte	Metall, vergoldet	Metall, vergoldet	Metall, vergoldet
Material Kontaktträger	Kunststoff, TPU	Kunststoff, TPU	Kunststoff, TPU
Material Griffkörper	Kunststoff, TPU	Kunststoff, TPU	Kunststoff, TPU
Material Überwurf	Metall, vernickelt	Metall, vernickelt	
Material Dichtung (Kupplung)	FPM/FKM	FPM/FKM	FPM/FKM
Normen	IEC 61076-2-101	IEC 61076-2-104	IEC 61076-2-104
Schutzart (montiert)	IP65, IP67, IP68	IP65, IP67, IP68	IP65, IP67, IP68
Mechanische Lebensdauer	>100 Steckzyklen	>100 Steckzyklen	>100 Steckzyklen
Verschmutzungsgrad	3	3/2	3/2

Automation Line bündelt die typischen Anforderungen der Automatisierungsbranche in einem Produkt: halogen-, PVC- und silikonfrei; schleppketteneignend; flammwidrig; chemikalien-, öl-, mikrobe- und hydrolysebeständig. Dazu dicht gemäß IP67 sowie UL-zugelassen. Das umfangreiche Portfolio beinhaltet: LED-Versionen; Ausführungen mit Gewindegriffkörper zur Befestigung von Schutzschläuchen; geschirmte Varianten mit 360°-Schirmung und patentierter ESCHA 2SSK-Technologie. Erhältlich mit drei Leitungsqualitäten: PVC, PUR und PURrobotic mit erhöhter Schleppketten- und Torsionsfähigkeit.

		Kopf				Leitung			Artikelbezeichnung	L = Leitungslänge*		
		Pol	U[max]	I[max]	LED	Material	Farbe	UL		2m / 1m	5m / 2m	10m / 5m
	Anschlussleitung Kupplung, M12x1, axial	3	250V	4A	PUR	BK	•	AL-WAK3-L/S370	8043798	8043799	8043800	
				4A	PUR	BK	•	AL-WAK3-L/S400	8075472	8075473	8075474	
				4A	PUR	GY	•	AL-WAK3-L/S370GY	8058853	8058854	8058855	
				4A	PUR	OG	•	AL-WAK3-L/S7400	8058862	8058863	8058864	
				4A	PVC	BK	•	AL-WAK3-L/P01BK	8081847	8081848	8081849	
				4A	PVC	GY	•	AL-WAK3-L/P01	8051250	8051251	8051252	
				4A	PVC	GY		AL-WAK3-L/P00	8051043	8051044	8051045	
		4	250V	4A	PUR	BK	•	AL-WAK4-L/S370	8043811	8043812	8043813	
				4A	PUR	BK	•	AL-WAK4-L/S400	8075490	8075491	8075492	
				4A	PUR	GY	•	AL-WAK4-L/S370GY	8058856	8058857	8058858	
				4A	PUR	OG	•	AL-WAK4-L/S7400	8058865	8058866	8058867	
				4A	PVC	BK	•	AL-WAK4-L/P01BK	8081859	8081860	8081861	
				4A	PVC	GY	•	AL-WAK4-L/P01	8051262	8051263	8051264	
				4A	PVC	GY		AL-WAK4-L/P00	8049341	8051055	8051056	
		4+PE	60V	4A	PUR	BK	•	AL-WAK5-L/S370	8045034	8045035	8046043	
				4A	PUR	BK	•	AL-WAK5-L/S400	8075529	8075530	8075531	
				4A	PUR	GY	•	AL-WAK5-L/S370GY	8058859	8058860	8058861	
				4A	PUR	OG	•	AL-WAK5-L/S7400	8058868	8058869	8058870	
				4A	PVC	BK	•	AL-WAK5-L/P01BK	8081871	8081872	8081873	
				4A	PVC	GY	•	AL-WAK5-L/P01	8051286	8051287	8051288	
				4A	PVC	GY		AL-WAK5-L/P00	8051077	8051078	8051079	
		5	60V	4A	PUR	BK	•	AL-WAK4.5-L/S370	8043823	8043824	8043825	
				4A	PUR	BK	•	AL-WAK4.5-L/S400	8075638	8075639	8075640	
				4A	PVC	GY	•	AL-WAK4.5-L/P01	8051274	8051275	8051276	
				4A	PVC	GY		AL-WAK4.5-L/P00	8051067	8051068	8051069	
		8	30V	2A	PUR	BK	•	AL-WAK8-L/S370	8046903	8046904	8046905	
				2A	PUR	BK	•	AL-WAK8-L/S400	8075556	8075557	8075558	
				2A	PVC	GY	•	AL-WAK8-L/P01	8051298	8051299	8051300	
2A	PVC			GY		AL-WAK8-L/P00	8051089	8051090	8051091			
12	30V	1,5A	PUR	BK	•	AL-WAK12-L/S370	8046918	8046920	8046921			
		1,5A	PUR	BK	•	AL-WAK12-L/S400	8075568	8075569	8075570			
		1,5A	PVC	GY	•	AL-WAK12-L/P01	8051310	8051311	8051312			
		1,5A	PVC	GY		AL-WAK12-L/P00	8051101	8051102	8051103			

* Unsere Standardleitungslängen sind 2m, 5m oder 10m für Anschlussleitungen und 1m, 2m oder 5m für Verbindungsleitungen. Die Litzenlänge bei Flanschen beträgt 0,5m (POWER 0,2m). Alle anderen Leitungs- und Litzenlängen liefern wir Ihnen gern auf Anfrage.

		Kopf				Leitung			UL	Artikelbezeichnung	L = Leitungslänge*		
		Pol	U[max]	I[max]	LED	Material	Farbe	2m / 1m			5m / 2m	10m / 5m	
	Anschlussleitung Kupplung, M12x1, axial, mit LED	3	30V	4A	3P2	PUR	BK	•	AL-WAK3P2-L/S370	8044524	8045592	8047386	
				4A	3P2	PUR	BK	•	AL-WAK3P2-L/S400	8075475	8075476	8075477	
				4A	3P2	PUR	GY	•	AL-WAK3P2-L/S370GY	8058922	8058923	8058924	
				4A	3P2	PUR	OG	•	AL-WAK3P2-L/S7400	8058928	8058929	8058930	
				4A	3P2	PVC	BK	•	AL-WAK3P2-L/P01BK	8082022	8082023	8082024	
				4A	3P2	PVC	GY	•	AL-WAK3P2-L/P01	8052511	8052512	8052513	
				4A	3P2	PVC	GY		AL-WAK3P2-L/P00	8052508	8052509	8052510	
		4	30V	4A	4P2	PUR	BK	•	AL-WAK4P2-L/S370	8048938	8048114	8048116	
				4A	4P2	PUR	BK	•	AL-WAK4P2-L/S400	8075493	8075494	8075495	
				4A	4P2	PUR	GY	•	AL-WAK4P2-L/S370GY	8058925	8058926	8058927	
				4A	4P2	PUR	OG	•	AL-WAK4P2-L/S7400	8058931	8058932	8058933	
				4A	4P2	PVC	BK	•	AL-WAK4P2-L/P01BK	8082025	8082026	8082027	
				4A	4P2	PVC	GY	•	AL-WAK4P2-L/P01	8052517	8052518	8052519	
				4A	4P2	PVC	GY		AL-WAK4P2-L/P00	8052514	8052515	8052516	
	Anschlussleitung Kupplung, M12x1, axial, mit Gewindegrieffkörper zur Schutzschlauchmontage	4	250V	4A		PUR	BK	•	AL-WAKG4-L/S370	8052820	8052821	8052822	
				4A		PUR	BK	•	AL-WAKG4-L/S400	8075496	8075497	8075498	
				4A		PUR	GY	•	AL-WAKG4-L/S370GY	8059086	8059087	8059088	
				4A		PUR	OG	•	AL-WAKG4-L/S7400	8059089	8059090	8059091	
				4A		PVC	BK	•	AL-WAKG4-L/P01BK	8082551	8082552	8082553	
				4A		PVC	GY	•	AL-WAKG4-L/P01	8052826	8052827	8052828	
				4A		PVC	GY		AL-WAKG4-L/P00	8052823	8052824	8052825	



* Unsere Standardleitungslängen sind 2m, 5m oder 10m für Anschlussleitungen und 1m, 2m oder 5m für Verbindungsleitungen. Die Litzenlänge bei Flanschen beträgt 0,5m (POWER 0,2m). Alle anderen Leitungs- und Litzenlängen liefern wir Ihnen gern auf Anfrage.

		Kopf				Leitung			Artikelbezeichnung	L = Leitungslänge*		
		Pol	U[max]	I[max]	LED	Material	Farbe	UL		2m / 1m	5m / 2m	10m / 5m
	Anschlussleitung Kupplung, M12x1, gewinkelt	3	250V	4A	PUR	BK	•	AL-WWAK3-L/S370	8043801	8043802	8043803	
				4A	PUR	BK	•	AL-WWAK3-L/S400	8075481	8075482	8075483	
				4A	PUR	GY	•	AL-WWAK3-L/S370GY	8058871	8058872	8058873	
				4A	PUR	OG	•	AL-WWAK3-L/S7400	8058880	8058881	8058882	
				4A	PVC	BK	•	AL-WWAK3-L/P01BK	8081850	8081851	8081852	
				4A	PVC	GY	•	AL-WWAK3-L/P01	8051253	8051254	8051255	
				4A	PVC	GY		AL-WWAK3-L/P00	8051046	8051047	8051048	
		4	250V	4A	PVC	BK	•	AL-WWAK4-L/P01BK	8081862	8081863	8081864	
				4A	PUR	BK	•	AL-WWAK4-L/S370	8043814	8043815	8043816	
				4A	PUR	BK	•	AL-WWAK4-L/S400	8075505	8075506	8075507	
				4A	PUR	GY	•	AL-WWAK4-L/S370GY	8058874	8058875	8058876	
				4A	PUR	OG	•	AL-WWAK4-L/S7400	8058883	8058884	8058885	
				4A	PVC	GY	•	AL-WWAK4-L/P01	8051265	8051266	8051267	
				4A	PVC	GY		AL-WWAK4-L/P00	8049342	8049343	8051057	
		4+PE	60V	4A	PUR	BK	•	AL-WWAK5-L/S370	8046021	8046022	8046023	
				4A	PUR	BK	•	AL-WWAK5-L/S400	8075535	8075536	8075537	
				4A	PUR	GY	•	AL-WWAK5-L/S370GY	8058877	8058878	8058879	
				4A	PUR	OG	•	AL-WWAK5-L/S7400	8058886	8058887	8058888	
				4A	PVC	BK	•	AL-WWAK5-L/P01BK	8081874	8081875	8081876	
				4A	PVC	GY	•	AL-WWAK5-L/P01	8051289	8051290	8051291	
				4A	PVC	GY		AL-WWAK5-L/P00	8051080	8051081	8051082	
		5	60V	4A	PUR	BK	•	AL-WWAK4.5-L/S370	8043826	8043827	8043828	
				4A	PUR	BK	•	AL-WWAK4.5-L/S400	8075550	8075551	8075552	
				4A	PVC	GY	•	AL-WWAK4.5-L/P01	8051277	8051278	8051279	
				4A	PVC	GY		AL-WWAK4.5-L/P00	8049344	8051070	8051071	
		8	30V	2A	PUR	BK	•	AL-WWAK8-L/S370	8046906	8046907	8046908	
				2A	PUR	BK	•	AL-WWAK8-L/S400	8075562	8075563	8075564	
				2A	PVC	GY	•	AL-WWAK8-L/P01	8051301	8051302	8051303	
				2A	PVC	GY		AL-WWAK8-L/P00	8051092	8051093	8051094	
		12	30V	1,5A	PUR	BK	•	AL-WWAK12-L/S370	8046923	8046924	8046925	
				1,5A	PUR	BK	•	AL-WWAK12-L/S400	8075574	8075575	8075576	
				1,5A	PVC	GY	•	AL-WWAK12-L/P01	8051313	8051314	8051315	
				1,5A	PVC	GY		AL-WWAK12-L/P00	8051104	8051105	8051106	



* Unsere Standardleitungslängen sind 2m, 5m oder 10m für Anschlussleitungen und 1m, 2m oder 5m für Verbindungsleitungen. Die Litzenlänge bei Flanschen beträgt 0,5m (POWER 0,2m). Alle anderen Leitungs- und Litzenlängen liefern wir Ihnen gern auf Anfrage.

		Kopf				Leitung			UL	Artikelbezeichnung	L = Leitungslänge*		
		Pol	U[max]	I[max]	LED	Material	Farbe	2m / 1m			5m / 2m	10m / 5m	
	Anschlussleitung Kupplung, M12x1, gewinkelt, mit LED	3	30V	4A	3P2	PUR	BK	•	AL-WWAK3P2-L/S370	8044219	8045217	8044523	
				4A	3P2	PUR	BK	•	AL-WWAK3P2-L/S400	8075484	8075485	8075486	
				4A	3P2	PUR	GY	•	AL-WWAK3P2-L/S370GY	8059930	8059931	8059932	
				4A	3P2	PUR	OG	•	AL-WWAK3P2-L/S7400	8058934	8058935	8058936	
				4A	3P2	PVC	BK	•	AL-WWAK3P2-L/P01BK	8081889	8081890	8081891	
				4A	3P2	PVC	GY	•	AL-WWAK3P2-L/P01	8051328	8051329	8051330	
				4A	3P2	PVC	GY		AL-WWAK3P2-L/P00	8051121	8051119	8051120	
		4	30V	4A	4P2	PUR	BK	•	AL-WWAK4P2-L/S370	8045237	8045238	8045239	
				4A	4P2	PUR	BK	•	AL-WWAK4P2-L/S400	8075508	8075509	8075510	
				4A	4P2	PUR	GY	•	AL-WWAK4P2-L/S370GY	8059933	8059934	8059935	
				4A	4P2	PUR	OG	•	AL-WWAK4P2-L/S7400	8058937	8058938	8058939	
				4A	4P2	PVC	BK	•	AL-WWAK4P2-L/P01BK	8081892	8081893	8081894	
				4A	4P2	PVC	GY	•	AL-WWAK4P2-L/P01	8051331	8051332	8051333	
				4A	4P2	PVC	GY		AL-WWAK4P2-L/P00	8051122	8051123	8051124	
				4A	4P3	PUR	BK	•	AL-WWAK4P3-L/S370	8044220	8044565	8044566	
				4A	4P3	PUR	BK	•	AL-WWAK4P3-L/S400	8075511	8075512	8075513	
				4A	4P3	PUR	GY	•	AL-WWAK4P3-L/S370GY	8059936	8059937	8059938	
				4A	4P3	PUR	OG	•	AL-WWAK4P3-L/S7400	8058940	8058941	8058942	
				4A	4P3	PVC	BK	•	AL-WWAK4P3-L/P01BK	8081895	8081896	8081897	
				4A	4P3	PVC	GY	•	AL-WWAK4P3-L/P01	8051334	8051335	8051336	
				4A	4P3	PVC	GY		AL-WWAK4P3-L/P00	8051125	8051126	8051127	
				4A	4P3.1	PUR	BK	•	AL-WWAK4P3.1-L/S370	8045911	8045912	8045913	
				4A	4P3.1	PUR	BK	•	AL-WWAK4P3.1-L/S400	8075514	8075515	8075516	
				4A	4P3.1	PUR	GY	•	AL-WWAK4P3.1-L/S370GY	8059939	8059940	8059941	
				4A	4P3.1	PUR	OG	•	AL-WWAK4P3.1-L/S7400	8058943	8058944	8058945	
				4A	4P3.1	PVC	BK	•	AL-WWAK4P3.1-L/P01BK	8081898	8081899	8081900	
				4A	4P3.1	PVC	GY	•	AL-WWAK4P3.1-L/P01	8051337	8051338	8051339	
				4A	4P3.1	PVC	GY		AL-WWAK4P3.1-L/P00	8051128	8051129	8051130	
				4A	4P3.2	PUR	BK	•	AL-WWAK4P3.2-L/S370	8045914	8045915	8045916	
				4A	4P3.2	PUR	BK	•	AL-WWAK4P3.2-L/S400	8075517	8075518	8075519	
				4A	4P3.2	PUR	GY	•	AL-WWAK4P3.2-L/S370GY	8059942	8059943	8059944	
				4A	4P3.2	PUR	OG	•	AL-WWAK4P3.2-L/S7400	8058946	8058947	8058948	
				4A	4P3.2	PVC	BK	•	AL-WWAK4P3.2-L/P01BK	8081901	8081902	8081903	
				4A	4P3.2	PVC	GY	•	AL-WWAK4P3.2-L/P01	8051340	8051341	8051342	
				4A	4P3.2	PVC	GY		AL-WWAK4P3.2-L/P00	8051131	8051132	8051133	

* Unsere Standardleitungslängen sind 2m, 5m oder 10m für Anschlussleitungen und 1m, 2m oder 5m für Verbindungsleitungen. Die Litzenlänge bei Flanschen beträgt 0,5m (POWER 0,2m). Alle anderen Leitungs- und Litzenlängen liefern wir Ihnen gern auf Anfrage.

		Kopf				Leitung			UL	Artikelbezeichnung	L = Leitungslänge*		
		Pol	U[max]	I[max]	LED	Material	Farbe	2m / 1m			5m / 2m	10m / 5m	
	Anschlussleitung Kupplung, M12x1, gewinkelt, mit LED	4+PE	30V	4A	5P3	PUR	BK	•	AL-WWAK5P3-L/S370	8044221	8045218	8045219	
				4A	5P3	PUR	BK	•	AL-WWAK5P3-L/S400	8075538	8075539	8075540	
				4A	5P3	PUR	GY	•	AL-WWAK5P3-L/S370GY	8059945	8059946	8059947	
				4A	5P3	PUR	OG	•	AL-WWAK5P3-L/S7400	8058949	8058950	8058951	
				4A	5P3	PVC	BK	•	AL-WWAK5P3-L/P01BK	8081904	8081905	8081906	
				4A	5P3	PVC	GY	•	AL-WWAK5P3-L/P01	8051343	8051344	8051345	
				4A	5P3	PVC	GY		AL-WWAK5P3-L/P00	8051134	8051135	8051136	
				4A	5P3.1	PUR	BK	•	AL-WWAK5P3.1-L/S370	8045917	8045918	8045919	
				4A	5P3.1	PUR	BK	•	AL-WWAK5P3.1-L/S400	8075541	8075542	8075543	
				4A	5P3.1	PUR	GY	•	AL-WWAK5P3.1-L/S370GY	8059948	8059949	8059950	
				4A	5P3.1	PUR	OG	•	AL-WWAK5P3.1-L/S7400	8058952	8058953	8058954	
				4A	5P3.1	PVC	BK	•	AL-WWAK5P3.1-L/P01BK	8081907	8081908	8081909	
				4A	5P3.1	PVC	GY	•	AL-WWAK5P3.1-L/P01	8051346	8051347	8051348	
				4A	5P3.1	PVC	GY		AL-WWAK5P3.1-L/P00	8051137	8051138	8051139	
	Anschlussleitung Kupplung, M12x1, gewinkelt, mit Gewindegrieffkörper zur Schutzschlauchmontage	4	250V	4A		PUR	BK	•	AL-WWAKG4-L/S370	8052829	8052830	8052831	
				4A		PUR	BK	•	AL-WWAKG4-L/S400	8075520	8075521	8075522	
				4A		PUR	GY	•	AL-WWAKG4-L/S370GY	8059092	8059093	8059094	
				4A		PUR	OG	•	AL-WWAKG4-L/S7400	8059095	8059096	8059097	
				4A		PVC	BK	•	AL-WWAKG4-L/P01BK	8082062	8082063	8082064	
				4A		PVC	GY	•	AL-WWAKG4-L/P01	8052835	8052836	8052837	
				4A		PVC	GY		AL-WWAKG4-L/P00	8052832	8052833	8052834	
					Anschlussleitung Stecker, M12x1, axial	3	250V	4A		PUR	BK	•	AL-WAS3-L/S370
4A		PUR	BK					•	AL-WAS3-L/S400	8075478	8075479	8075480	
4A		PUR	GY					•	AL-WAS3-L/S370GY	8058955	8058956	8058957	
4A		PUR	OG					•	AL-WAS3-L/S7400	8058964	8058965	8058966	
4A		PVC	BK					•	AL-WAS3-L/P01BK	8081853	8081854	8081855	
4A		PVC	GY					•	AL-WAS3-L/P01	8051256	8051257	8051258	
4A		PVC	GY						AL-WAS3-L/P00	8051049	8051050	8051051	
4	250V	4A				PUR	BK	•	AL-WAS4-L/S370	8043817	8043818	8043819	
		4A				PUR	BK	•	AL-WAS4-L/S400	8075499	8075500	8075501	
		4A				PUR	GY	•	AL-WAS4-L/S370GY	8058958	8058959	8058960	
4A		PUR	OG	•	AL-WAS4-L/S7400	8058967	8058968	8058969					
4A		PVC	BK	•	AL-WAS4-L/P01BK	8081865	8081866	8081867					
4A		PVC	GY	•	AL-WAS4-L/P01	8051268	8051269	8051270					
4A		PVC	GY		AL-WAS4-L/P00	8049339	8051058	8051059					



* Unsere Standardleitungslängen sind 2m, 5m oder 10m für Anschlussleitungen und 1m, 2m oder 5m für Verbindungsleitungen. Die Litzenlänge bei Flanschen beträgt 0,5m (POWER 0,2m). Alle anderen Leitungs- und Litzenlängen liefern wir Ihnen gern auf Anfrage.

		Kopf				Leitung			Artikelbezeichnung	L = Leitungslänge*		
		Pol	U[max]	I[max]	LED	Material	Farbe	UL		2m / 1m	5m / 2m	10m / 5m
	Anschlussleitung Stecker, M12x1, axial	4+PE	60V	4A	PUR	BK	•	AL-WAS5-L/S370	8046024	8046026	8046027	
				4A	PUR	BK	•	AL-WAS5-L/S400	8075532	8075533	8075534	
				4A	PUR	GY	•	AL-WAS5-L/S370GY	8058961	8058962	8058963	
				4A	PUR	OG	•	AL-WAS5-L/S7400	8058970	8058971	8058972	
				4A	PVC	BK	•	AL-WAS5-L/P01BK	8081877	8081878	8081879	
				4A	PVC	GY	•	AL-WAS5-L/P01	8051292	8051293	8051294	
				4A	PVC	GY		AL-WAS5-L/P00	8051083	8051084	8051085	
		5	60V	4A	PUR	BK	•	AL-WAS4.5-L/S370	8043829	8043830	8043831	
				4A	PUR	BK	•	AL-WAS4.5-L/S400	8075547	8075548	8075549	
				4A	PVC	GY	•	AL-WAS4.5-L/P01	8051280	8051281	8051282	
				4A	PVC	GY		AL-WAS4.5-L/P00	8051072	8051073	8049345	
		8	30V	2A	PUR	BK	•	AL-WAS8-L/S370	8046909	8046910	8046911	
				2A	PUR	BK	•	AL-WAS8-L/S400	8075559	8075560	8075561	
				2A	PVC	GY	•	AL-WAS8-L/P01	8051304	8051305	8051306	
				2A	PVC	GY		AL-WAS8-L/P00	8051095	8051096	8051097	
		12	30V	1,5A	PUR	BK	•	AL-WAS12-L/S370	8046926	8046927	8046928	
				1,5A	PUR	BK	•	AL-WAS12-L/S400	8075571	8075572	8075573	
				1,5A	PVC	GY	•	AL-WAS12-L/P01	8051316	8051317	8051318	
				1,5A	PVC	GY		AL-WAS12-L/P00	8051107	8051108	8051109	
			Anschlussleitung Stecker, M12x1, axial, mit Gewindegriffkörper zur Schutzschlauchmontage	4	250V	4A	PUR	BK	•	AL-WASG4-L/S370	8052838	8052839
4A	PUR					BK	•	AL-WASG4-L/S400	8075502	8075503	8075504	
4A	PUR					GY	•	AL-WASG4-L/S370GY	8059098	8059099	8059100	
4A	PUR					OG	•	AL-WASG4-L/S7400	8059101	8059102	8059103	
4A	PVC					BK	•	AL-WASG4-L/P01BK	8082065	8082066	8082067	
4A	PVC					GY	•	AL-WASG4-L/P01	8052844	8052845	8052846	
4A	PVC					GY		AL-WASG4-L/P00	8052841	8052842	8052843	

* Unsere Standardleitungslängen sind 2m, 5m oder 10m für Anschlussleitungen und 1m, 2m oder 5m für Verbindungsleitungen. Die Litzenlänge bei Flanschen beträgt 0,5m (POWER 0,2m). Alle anderen Leitungs- und Litzenlängen liefern wir Ihnen gern auf Anfrage.

		Kopf				Leitung			Artikelbezeichnung	L = Leitungslänge*		
		Pol	U[max]	I[max]	LED	Material	Farbe	UL		2m / 1m	5m / 2m	10m / 5m
	Anschlussleitung Stecker, M12x1, gewinkelt	3	250V	4A	PUR	BK	•	AL-WWAS3-L/S370	8043808	8043809	8043810	
				4A	PUR	BK	•	AL-WWAS3-L/S400	8075487	8075488	8075489	
				4A	PUR	GY	•	AL-WWAS3-L/S370GY	8058973	8058974	8058975	
				4A	PUR	OG	•	AL-WWAS3-L/S7400	8058982	8058983	8058984	
				4A	PVC	BK	•	AL-WWAS3-L/P01BK	8081856	8081857	8081858	
				4A	PVC	GY	•	AL-WWAS3-L/P01	8051259	8051260	8051261	
				4A	PVC	GY		AL-WWAS3-L/P00	8051052	8051053	8051054	
		4	250V	4A	PUR	BK	•	AL-WWAS4-L/S370	8043820	8043821	8043822	
				4A	PUR	BK	•	AL-WWAS4-L/S400	8075523	8075524	8075525	
				4A	PUR	GY	•	AL-WWAS4-L/S370GY	8058976	8058977	8058978	
				4A	PUR	OG	•	AL-WWAS4-L/S7400	8058985	8058986	8058987	
				4A	PVC	BK	•	AL-WWAK4-L/P01BK	8081862	8081863	8081864	
				4A	PVC	BK	•	AL-WWAS4-L/P01BK	8081868	8081869	8081870	
				4A	PVC	GY	•	AL-WWAS4-L/P01	8051271	8051272	8051273	
		4+PE	60V	4A	PVC	GY		AL-WWAS4-L/P00	8051869	8051870	8051871	
				4A	PUR	BK	•	AL-WWAS5-L/S370	8046028	8046029	8046030	
				4A	PUR	BK	•	AL-WWAS5-L/S400	8075544	8075545	8075546	
				4A	PUR	GY	•	AL-WWAS5-L/S370GY	8058979	8058980	8058981	
				4A	PUR	OG	•	AL-WWAS5-L/S7400	8058988	8058989	8058990	
				4A	PVC	BK	•	AL-WWAS5-L/P01BK	8081880	8081881	8081882	
				4A	PVC	GY	•	AL-WWAS5-L/P01	8051295	8051296	8051297	
		5	60V	4A	PVC	GY		AL-WWAS5-L/P00	8051086	8051087	8051088	
				4A	PUR	BK	•	AL-WWAS4.5-L/S370	8043832	8043833	8043834	
				4A	PUR	BK	•	AL-WWAS4.5-L/S400	8075553	8075554	8075555	
				4A	PVC	GY	•	AL-WWAS4.5-L/P01	8051283	8051284	8051285	
		8	30V	4A	PVC	GY		AL-WWAS4.5-L/P00	8051074	8051075	8051076	
				2A	PUR	BK	•	AL-WWAS8-L/S370	8046912	8046913	8046914	
				2A	PUR	BK	•	AL-WWAS8-L/S400	8075565	8075566	8075567	
				2A	PVC	GY	•	AL-WWAS8-L/P01	8051307	8051308	8051309	
		12	30V	2A	PVC	GY		AL-WWAS8-L/P00	8051098	8051099	8051100	
				1,5A	PUR	BK	•	AL-WWAS12-L/S370	8046929	8046930	8046931	
				1,5A	PUR	BK	•	AL-WWAS12-L/S400	8075577	8075578	8075579	
				1,5A	PVC	GY	•	AL-WWAS12-L/P01	8051319	8051321	8051320	
				1,5A	PVC	GY		AL-WWAS12-L/P00	8051110	8051111	8051112	

* Unsere Standardleitungslängen sind 2m, 5m oder 10m für Anschlussleitungen und 1m, 2m oder 5m für Verbindungsleitungen. Die Litzenlänge bei Flanschen beträgt 0,5m (POWER 0,2m). Alle anderen Leitungs- und Litzenlängen liefern wir Ihnen gern auf Anfrage.

		Kopf				Leitung			Artikelbezeichnung	L = Leitungslänge*		
		Pol	U[max]	I[max]	LED	Material	Farbe	UL		2m / 1m	5m / 2m	10m / 5m
	Anschlussleitung Stecker, M12x1, gewinkelt, mit Gewindegriffkörper zur Schutzschlauchmontage	4	250V	4A	PUR	BK	•	AL-WWASG4-L/S370	8052847	8052848	8052849	
				4A	PUR	BK	•	AL-WWASG4-L/S400	8075526	8075527	8075528	
				4A	PUR	GY	•	AL-WWASG4-L/S370GY	8059104	8059105	8059106	
				4A	PUR	OG	•	AL-WWASG4-L/S7400	8059107	8059108	8059109	
				4A	PVC	BK	•	AL-WWASG4-L/P01BK	8082068	8082069	8082070	
				4A	PVC	GY	•	AL-WWASG4-L/P01	8052853	8052854	8052855	
				4A	PVC	GY		AL-WWASG4-L/P00	8052850	8052851	8052852	
	Verbindungsleitung Kupplung, M12x1, axial Stecker, M12x1, axial	3	250V	4A	PUR	BK	•	AL-WAK3-L-AL-WAS3/S370	8044858	8044029	8044030	
				4A	PUR	GY	•	AL-WAK3-L-AL-WAS3/S370GY	8058889	8058890	8058891	
				4A	PUR	OG	•	AL-WAK3-L-AL-WAS3/S7400	8058921	8058898	8058899	
				4A	PVC	BK	•	AL-WAK3-L-AL-WAS3/P01BK	8081952	8081953	8081954	
				4A	PVC	GY	•	AL-WAK3-L-AL-WAS3/P01	8051667	8051668	8051669	
				4A	PVC	GY		AL-WAK3-L-AL-WAS3/P00	8051459	8051460	8051461	
	4	250V	4A	PUR	BK	•	AL-WAK4-L-AL-WAS4/S370	8044813	8044041	8044042		
			4A	PUR	GY	•	AL-WAK4-L-AL-WAS4/S370GY	8058892	8058893	8058894		
			4A	PUR	OG	•	AL-WAK4-L-AL-WAS4/S7400	8057296	8057322	8057324		
			4A	PVC	BK	•	AL-WAK4-L-AL-WAS4/P01BK	8081964	8081965	8081966		
			4A	PVC	GY	•	AL-WAK4-L-AL-WAS4/P01	8051679	8051680	8051681		
			4A	PVC	GY		AL-WAK4-L-AL-WAS4/P00	8051471	8051472	8051473		
	4+PE	60V	4A	PUR	BK	•	AL-WAK5-L-AL-WAS5/S370	8046647	8046031	8046032		
			4A	PUR	GY	•	AL-WAK5-L-AL-WAS5/S370GY	8058895	8058896	8058897		
			4A	PUR	OG	•	AL-WAK5-L-AL-WAS5/S7400	8058900	8058901	8058902		
			4A	PVC	BK	•	AL-WAK5-L-AL-WAS5/P01BK	8081976	8081977	8081978		
			4A	PVC	GY	•	AL-WAK5-L-AL-WAS5/P01	8051703	8051704	8051705		
			4A	PVC	GY		AL-WAK5-L-AL-WAS5/P00	8051495	8051496	8051497		
	5	60V	4A	PUR	BK	•	AL-WAK4.5-L-AL-WAS4.5/S370	8050226	8044053	8044054		
			4A	PVC	GY	•	AL-WAK4.5-L-AL-WAS4.5/P01	8051691	8051692	8051693		
			4A	PVC	GY		AL-WAK4.5-L-AL-WAS4.5/P00	8051483	8051484	8051485		
8	30V	2A	PUR	BK	•	AL-WAK8-L-AL-WAS8/S370	8049781	8046932	8046933			
		2A	PVC	GY	•	AL-WAK8-L-AL-WAS8/P01	8051715	8051716	8051717			
		2A	PVC	GY		AL-WAK8-L-AL-WAS8/P00	8051507	8051508	8051509			
12	30V	1,5A	PUR	BK	•	AL-WAK12-L-AL-WAS12/S370	8051872	8046944	8046945			
		1,5A	PVC	GY	•	AL-WAK12-L-AL-WAS12/P01	8051727	8051728	8051729			
		1,5A	PVC	GY		AL-WAK12-L-AL-WAS12/P00	8051519	8051520	8051521			

* Unsere Standardleitungslängen sind 2m, 5m oder 10m für Anschlussleitungen und 1m, 2m oder 5m für Verbindungsleitungen. Die Litzenlänge bei Flanschen beträgt 0,5m (POWER 0,2m). Alle anderen Leitungs- und Litzenlängen liefern wir Ihnen gern auf Anfrage.

		Kopf				Leitung			Artikelbezeichnung	L = Leitungslänge*		
		Pol	U[max]	I[max]	LED	Material	Farbe	UL		2m / 1m	5m / 2m	10m / 5m
	Verbindungsleitung Kupplung, M12x1, axial Stecker, M12x1, gewinkelt	3	250V	4A	PUR	BK	•	AL-WAK3-L-AL-WWAS3/S370	8051873	8044035	8044036	
				4A	PUR	GY	•	AL-WAK3-L-AL-WWAS3/S370GY	8058903	8058904	8058905	
				4A	PUR	OG	•	AL-WAK3-L-AL-WWAS3/S7400	8058912	8058913	8058914	
				4A	PVC	BK	•	AL-WAK3-L-AL-WWAS3/P01BK	8081958	8081959	8081960	
				4A	PVC	GY	•	AL-WAK3-L-AL-WWAS3/P01	8051673	8051674	8051675	
				4A	PVC	GY		AL-WAK3-L-AL-WWAS3/P00	8051465	8051466	8051467	
		4	250V	4A	PUR	BK	•	AL-WAK4-L-AL-WWAS4/S370	8051874	8044047	8044048	
				4A	PUR	GY	•	AL-WAK4-L-AL-WWAS4/S370GY	8058906	8058907	8058908	
				4A	PUR	OG	•	AL-WAK4-L-AL-WWAS4/S7400	8058915	8058916	8058917	
				4A	PVC	BK	•	AL-WAK4-L-AL-WWAS4/P01BK	8081970	8081971	8081972	
				4A	PVC	GY	•	AL-WAK4-L-AL-WWAS4/P01	8051685	8051686	8051687	
				4A	PVC	GY		AL-WAK4-L-AL-WWAS4/P00	8051477	8051478	8051479	
		4+PE	60V	4A	PUR	BK	•	AL-WAK5-L-AL-WWAS5/S370	8046056	8046037	8046038	
				4A	PUR	GY	•	AL-WAK5-L-AL-WWAS5/S370GY	8058909	8058910	8058911	
				4A	PUR	OG	•	AL-WAK5-L-AL-WWAS5/S7400	8058918	8058919	8058920	
				4A	PVC	BK	•	AL-WAK5-L-AL-WWAS5/P01BK	8081982	8081983	8081984	
				4A	PVC	GY	•	AL-WAK5-L-AL-WWAS5/P01	8051709	8051710	8051711	
				4A	PVC	GY		AL-WAK5-L-AL-WWAS5/P00	8051501	8051502	8051503	
		5	60V	4A	PUR	BK	•	AL-WAK4.5-L-AL-WWAS4.5/S370	8051875	8044059	8044060	
				4A	PVC	GY	•	AL-WAK4.5-L-AL-WWAS4.5/P01	8051697	8051698	8051699	
				4A	PVC	GY		AL-WAK4.5-L-AL-WWAS4.5/P00	8051489	8051490	8051491	
8	30V	2A	PUR	BK	•	AL-WAK8-L-AL-WWAS8/S370	8051876	8046938	8046939			
		2A	PVC	GY	•	AL-WAK8-L-AL-WWAS8/P01	8051721	8051722	8051723			
		2A	PVC	GY		AL-WAK8-L-AL-WWAS8/P00	8051513	8051514	8051515			
12	30V	1,5A	PUR	BK	•	AL-WAK12-L-AL-WWAS12/S370	8051877	8046950	8046951			
		1,5A	PVC	GY	•	AL-WAK12-L-AL-WWAS12/P01	8051733	8051734	8051735			
		1,5A	PVC	GY		AL-WAK12-L-AL-WWAS12/P00	8051525	8051526	8051527			

* Unsere Standardleitungslängen sind 2m, 5m oder 10m für Anschlussleitungen und 1m, 2m oder 5m für Verbindungsleitungen. Die Litzenlänge bei Flanschen beträgt 0,5m (POWER 0,2m). Alle anderen Leitungs- und Litzenlängen liefern wir Ihnen gern auf Anfrage.

		Kopf				Leitung			Artikelbezeichnung	L = Leitungslänge*		
		Pol	U[max]	I[max]	LED	Material	Farbe	UL		2m / 1m	5m / 2m	10m / 5m
 Verbindungsleitung Kupplung, M12x1, axial, mit LED Stecker, M12x1, axial	3	30V	4A	3P2	PUR	BK		AL-WAK3P2-L-AL-WAS3/S370	8052751	8049895	8049896	
			4A	3P2	PUR	GY		AL-WAK3P2-L-AL-WAS3/S370GY	8059034	8059035	8059036	
			4A	3P2	PUR	OG		AL-WAK3P2-L-AL-WAS3/S7400	8059040	8059041	8059042	
			4A	3P2	PVC	BK		AL-WAK3P2-L-AL-WAS3/P01BK	8082059	8082060	8082061	
			4A	3P2	PVC	GY		AL-WAK3P2-L-AL-WAS3/P00	8052745	8052747	8052746	
			4A	3P2	PVC	GY		AL-WAK3P2-L-AL-WAS3/P01	8052749	8052748	8052750	
	4	30V	4A	4P2	PUR	BK	•	AL-WAK4P2-L-AL-WAS4/S370	8049946	8052064	8052065	
			4A	4P2	PUR	GY	•	AL-WAK4P2-L-AL-WAS4/S370GY	8059037	8059038	8059039	
			4A	4P2	PUR	OG	•	AL-WAK4P2-L-AL-WAS4/S7400	8059043	8059044	8059045	
			4A	4P2	PVC	BK	•	AL-WAK4P2-L-AL-WAS4/P01BK	8082028	8082029	8082030	
			4A	4P2	PVC	GY	•	AL-WAK4P2-L-AL-WAS4/P01	8052523	8052524	8052525	
			4A	4P2	PVC	GY		AL-WAK4P2-L-AL-WAS4/P00	8052520	8052521	8052522	

* Unsere Standardleitungslängen sind 2m, 5m oder 10m für Anschlussleitungen und 1m, 2m oder 5m für Verbindungsleitungen. Die Litzenlänge bei Flanschen beträgt 0,5m (POWER 0,2m). Alle anderen Leitungs- und Litzenlängen liefern wir Ihnen gern auf Anfrage.

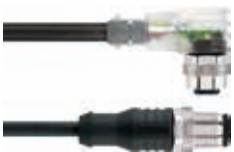

		Kopf				Leitung			Artikelbezeichnung	L = Leitungslänge*		
		Pol	U[max]	I[max]	LED	Material	Farbe	UL		2m / 1m	5m / 2m	10m / 5m
	Verbindungsleitung Kupplung, M12x1, gewinkelt Stecker, M12x1, axial	3	250V	4A	PUR	BK	•	AL-WWAK3-L-AL-WAS3/S370	8047133	8044038	8044039	
				4A	PUR	GY	•	AL-WWAK3-L-AL-WAS3/S370GY	8058998	8058999	8059000	
				4A	PUR	OG	•	AL-WWAK3-L-AL-WAS3/S7400	8059007	8059008	8059009	
				4A	PVC	BK	•	AL-WWAK3-L-AL-WAS3/P01BK	8081961	8081962	8081963	
				4A	PVC	GY	•	AL-WWAK3-L-AL-WAS3/P01	8051676	8051677	8051678	
				4A	PVC	GY	•	AL-WWAK3-L-AL-WAS3/P00	8051468	8051469	8051470	
		4	250V	4A	PUR	BK	•	AL-WWAK4-L-AL-WAS4/S370	8044664	8044050	8044051	
				4A	PUR	GY	•	AL-WWAK4-L-AL-WAS4/S370GY	8059001	8059002	8059003	
				4A	PUR	OG	•	AL-WWAK4-L-AL-WAS4/S7400	8059010	8059011	8059012	
				4A	PVC	BK	•	AL-WWAK4-L-AL-WAS4/P01BK	8081973	8081974	8081975	
				4A	PVC	GY	•	AL-WWAK4-L-AL-WAS4/P01	8051688	8051689	8051690	
				4A	PVC	GY	•	AL-WWAK4-L-AL-WAS4/P00	8051480	8051481	8051482	
		4+PE	60V	4A	PUR	BK	•	AL-WWAK5-L-AL-WAS5/S370	8046055	8046040	8046041	
				4A	PUR	GY	•	AL-WWAK5-L-AL-WAS5/S370GY	8059004	8059005	8059006	
				4A	PUR	OG	•	AL-WWAK5-L-AL-WAS5/S7400	8059013	8059014	8059015	
				4A	PVC	BK	•	AL-WWAK5-L-AL-WAS5/P01BK	8081985	8081986	8081987	
				4A	PVC	GY	•	AL-WWAK5-L-AL-WAS5/P01	8051712	8051713	8051714	
				4A	PVC	GY	•	AL-WWAK5-L-AL-WAS5/P00	8051504	8051505	8051506	
5	60V	4A	PUR	BK	•	AL-WWAK4.5-L-AL-WAS4.5/S370	8050444	8044062	8044063			
		4A	PVC	GY	•	AL-WWAK4.5-L-AL-WAS4.5/P01	8051700	8051701	8051702			
		4A	PVC	GY	•	AL-WWAK4.5-L-AL-WAS4.5/P00	8051492	8051493	8051494			
8	30V	2A	PUR	BK	•	AL-WWAK8-L-AL-WAS8/S370	8048889	8046941	8046942			
		2A	PVC	GY	•	AL-WWAK8-L-AL-WAS8/P01	8051724	8051725	8051726			
		2A	PVC	GY	•	AL-WWAK8-L-AL-WAS8/P00	8051516	8051517	8051518			
12	30V	1,5A	PUR	BK	•	AL-WWAK12-L-AL-WAS12/S370	8051878	8046953	8046954			
		1,5A	PVC	GY	•	AL-WWAK12-L-AL-WAS12/P01	8051736	8051737	8051738			
		1,5A	PVC	GY	•	AL-WWAK12-L-AL-WAS12/P00	8051528	8051529	8051530			

* Unsere Standardleitungslängen sind 2m, 5m oder 10m für Anschlussleitungen und 1m, 2m oder 5m für Verbindungsleitungen. Die Litzenlänge bei Flanschen beträgt 0,5m (POWER 0,2m). Alle anderen Leitungs- und Litzenlängen liefern wir Ihnen gern auf Anfrage.

		Kopf				Leitung			Artikelbezeichnung	L = Leitungslänge*		
		Pol	U[max]	I[max]	LED	Material	Farbe	UL		2m / 1m	5m / 2m	10m / 5m
	Verbindungsleitung Kupplung, M12x1, gewinkelt Stecker, M12x1, gewinkelt	3	250V	4A		PUR	BK	•	AL-WWAK3-L-AL-WWAS3/S370	8049108	8044032	8044033
				4A		PUR	GY	•	AL-WWAK3-L-AL-WWAS3/S370GY	8059016	8059017	8059018
				4A		PUR	OG	•	AL-WWAK3-L-AL-WWAS3/S7400	8059025	8059026	8059027
				4A		PVC	BK	•	AL-WWAK3-L-AL-WWAS3/P01BK	8081955	8081956	8081957
				4A		PVC	GY	•	AL-WWAK3-L-AL-WWAS3/P01	8051671	8051670	8051672
				4A		PVC	GY		AL-WWAK3-L-AL-WWAS3/P00	8051462	8051463	8051464
		4	250V	4A		PUR	BK	•	AL-WWAK4-L-AL-WWAS4/S370	8051879	8044044	8044045
				4A		PUR	GY	•	AL-WWAK4-L-AL-WWAS4/S370GY	8059019	8059020	8059021
				4A		PUR	OG	•	AL-WWAK4-L-AL-WWAS4/S7400	8059028	8059029	8059030
				4A		PVC	BK	•	AL-WWAK4-L-AL-WWAS4/P01BK	8081967	8081968	8081969
				4A		PVC	GY	•	AL-WWAK4-L-AL-WWAS4/P01	8051682	8051683	8051684
				4A		PVC	GY		AL-WWAK4-L-AL-WWAS4/P00	8051474	8051475	8051476
		4+PE	60V	4A		PUR	BK	•	AL-WWAK5-L-AL-WWAS5/S370	8051881	8046034	8046035
				4A		PUR	GY	•	AL-WWAK5-L-AL-WWAS5/S370GY	8059022	8059023	8059024
				4A		PUR	OG	•	AL-WWAK5-L-AL-WWAS5/S7400	8059031	8059032	8059033
				4A		PVC	BK	•	AL-WWAK5-L-AL-WWAS5/P01BK	8081979	8081980	8081981
				4A		PVC	GY	•	AL-WWAK5-L-AL-WWAS5/P01	8051706	8051707	8051708
				4A		PVC	GY		AL-WWAK5-L-AL-WWAS5/P00	8051498	8051499	8051500
5	60V	4A		PUR	BK	•	AL-WWAK4.5-L-AL-WWAS4.5/S370	8051880	8044056	8044057		
		4A		PVC	GY	•	AL-WWAK4.5-L-AL-WWAS4.5/P01	8051694	8051695	8051696		
		4A		PVC	GY		AL-WWAK4.5-L-AL-WWAS4.5/P00	8051486	8051487	8051488		
8	30V	2A		PUR	BK	•	AL-WWAK8-L-AL-WWAS8/S370	8051882	8046935	8046936		
		2A		PVC	GY	•	AL-WWAK8-L-AL-WWAS8/P01	8051718	8051719	8051720		
		2A		PVC	GY		AL-WWAK8-L-AL-WWAS8/P00	8051510	8051511	8051512		
12	30V	1,5A		PUR	BK	•	AL-WWAK12-L-AL-WWAS12/S370	8051883	8046947	8046948		
		1,5A		PVC	GY	•	AL-WWAK12-L-AL-WWAS12/P01	8051730	8051731	8051732		
		1,5A		PVC	GY		AL-WWAK12-L-AL-WWAS12/P00	8051522	8051523	8051524		
	Verbindungsleitung Kupplung, M12x1, gewinkelt, mit LED Stecker, M12x1, axial	3	30V	4A	3P2	PUR	BK	•	AL-WWAK3P2-L-AL-WAS3/S370	8048160	8045579	8045503
				4A	3P2	PUR	GY	•	AL-WWAK3P2-L-AL-WAS3/S370GY	8059046	8059047	8059048
				4A	3P2	PUR	OG	•	AL-WWAK3P2-L-AL-WAS3/S7400	8059067	8059068	8059069
				4A	3P2	PVC	BK	•	AL-WWAK3P2-L-AL-WAS3/P01BK	8081991	8081992	8081993
				4A	3P2	PVC	GY	•	AL-WWAK3P2-L-AL-WAS3/P01	8051745	8051746	8051747
				4A	3P2	PVC	GY		AL-WWAK3P2-L-AL-WAS3/P00	8051537	8051538	8051539

* Unsere Standardleitungslängen sind 2m, 5m oder 10m für Anschlussleitungen und 1m, 2m oder 5m für Verbindungsleitungen. Die Litzenlänge bei Flanschen beträgt 0,5m (POWER 0,2m). Alle anderen Leitungs- und Litzenlängen liefern wir Ihnen gern auf Anfrage.



		Kopf				Leitung			UL	Artikelbezeichnung	L = Leitungslänge*					
		Pol	U[max]	I[max]	LED	Material	Farbe	2m / 1m			5m / 2m	10m / 5m				
	Verbindungsleitung Kupplung, M12x1, gewinkelt, mit LED Stecker, M12x1, axial	4	30V	4A	4P2	PUR	BK	•	AL-WWAK4P2-L-AL-WAS4/S370	8043925	8045920	8045921				
				4A	4P2	PUR	GY	•	AL-WWAK4P2-L-AL-WAS4/S370GY	8059049	8059050	8059051				
				4A	4P2	PUR	OG	•	AL-WWAK4P2-L-AL-WAS4/S7400	8059070	8059071	8059072				
				4A	4P2	PVC	BK	•	AL-WWAK4P2-L-AL-WAS4/P01BK	8081994	8081995	8081996				
				4A	4P2	PVC	GY	•	AL-WWAK4P2-L-AL-WAS4/P01	8051748	8051749	8051750				
				4A	4P2	PVC	GY		AL-WWAK4P2-L-AL-WAS4/P00	8051540	8051541	8051542				
				4A	4P3	PUR	BK	•	AL-WWAK4P3-L-AL-WAS4/S370	8049739	8045923	8045924				
				4A	4P3	PUR	GY	•	AL-WWAK4P3-L-AL-WAS4/S370GY	8059052	8059053	8059054				
				4A	4P3	PUR	OG	•	AL-WWAK4P3-L-AL-WAS4/S7400	8058054	8057297	8057321				
				4A	4P3	PVC	BK	•	AL-WWAK4P3-L-AL-WAS4/P01BK	8081997	8081998	8081999				
				4A	4P3	PVC	GY	•	AL-WWAK4P3-L-AL-WAS4/P01	8051751	8051752	8051753				
				4A	4P3	PVC	GY		AL-WWAK4P3-L-AL-WAS4/P00	8051543	8051545	8051544				
				4A	4P3.1	PUR	BK	•	AL-WWAK4P3.1-L-AL-WAS4/S370	8051884	8045926	8045927				
				4A	4P3.1	PUR	GY	•	AL-WWAK4P3.1-L-AL-WAS4/S370GY	8059055	8059056	8059057				
				4A	4P3.1	PUR	OG	•	AL-WWAK4P3.1-L-AL-WAS4/S7400	8059073	8059074	8059075				
				4A	4P3.1	PVC	BK	•	AL-WWAK4P3.1-L-AL-WAS4/P01BK	8082000	8082001	8082002				
				4A	4P3.1	PVC	GY	•	AL-WWAK4P3.1-L-AL-WAS4/P01	8051754	8051755	8051756				
				4A	4P3.1	PVC	GY		AL-WWAK4P3.1-L-AL-WAS4/P00	8051546	8051547	8051548				
				4A	4P3.2	PUR	BK	•	AL-WWAK4P3.2-L-AL-WAS4/S370	8048140	8045929	8045930				
				4A	4P3.2	PUR	GY	•	AL-WWAK4P3.2-L-AL-WAS4/S370GY	8059058	8059059	8059060				
				4A	4P3.2	PUR	OG	•	AL-WWAK4P3.2-L-AL-WAS4/S7400	8059076	8059077	8059078				
				4A	4P3.2	PVC	BK	•	AL-WWAK4P3.2-L-AL-WAS4/P01BK	8082004	8082005	8082006				
				4A	4P3.2	PVC	GY	•	AL-WWAK4P3.2-L-AL-WAS4/P01	8051757	8051758	8051759				
				4A	4P3.2	PVC	GY		AL-WWAK4P3.2-L-AL-WAS4/P00	8051549	8051550	8051551				
						4+PE	30V	4A	5P3	PUR	BK	•	AL-WWAK5P3-L-AL-WAS5/S370	8051885	8045581	8045583
								4A	5P3	PUR	GY	•	AL-WWAK5P3-L-AL-WAS5/S370GY	8059061	8059062	8059063
								4A	5P3	PUR	OG	•	AL-WWAK5P3-L-AL-WAS5/S7400	8059079	8059080	8059081
								4A	5P3	PVC	BK	•	AL-WWAK5P3-L-AL-WAS5/P01BK	8082007	8082008	8082009
								4A	5P3	PVC	GY	•	AL-WWAK5P3-L-AL-WAS5/P01	8051760	8051761	8051762
								4A	5P3	PVC	GY		AL-WWAK5P3-L-AL-WAS5/P00	8051552	8051553	8051554
								4A	5P3.1	PUR	BK	•	AL-WWAK5P3.1-L-AL-WAS5/S370	8045017	8045661	8045662
								4A	5P3.1	PUR	GY	•	AL-WWAK5P3.1-L-AL-WAS5/S370GY	8059064	8059065	8059066
				4A	5P3.1	PUR	OG	•	AL-WWAK5P3.1-L-AL-WAS5/S7400	8059082	8059083	8059084				
				4A	5P3.1	PVC	BK	•	AL-WWAK5P3.1-L-AL-WAS5/P01BK	8082010	8082011	8082012				
				4A	5P3.1	PVC	GY	•	AL-WWAK5P3.1-L-AL-WAS5/P01	8051763	8051764	8051765				
				4A	5P3.1	PVC	GY		AL-WWAK5P3.1-L-AL-WAS5/P00	8051555	8051556	8051557				

		Kopf				Leitung			Artikelbezeichnung	L = Leitungslänge*		
		Pol	U[max]	I[max]	LED	Material	Farbe	UL		2m / 1m	5m / 2m	10m / 5m
	Anschlussleitung Kupplung, M12x1, axial geschirmt	3	250V	4A	PUR	BK	•	AL-WAKS3-L/S370	8046217	8046218	8046219	
				4A	PVC	GY	•	AL-WAKS3-L/P01	8051374	8051375	8051376	
				4A	PVC	GY		AL-WAKS3-L/P00	8051164	8051165	8051166	
		4	250V	4A	PUR	BK	•	AL-WAKS4-L/S370	8046229	8046230	8046231	
				4A	PVC	GY	•	AL-WAKS4-L/P01	8051386	8051387	8051388	
				4A	PVC	GY		AL-WAKS4-L/P00	8051176	8051177	8051178	
		5	60V	4A	PUR	BK	•	AL-WAKS4.5-L/S370	8045557	8046239	8046240	
				4A	PVC	GY		AL-WAKS4.5-L/P00	8051188	8051189	8051190	
				4A	PVC	GY	•	AL-WAKS4.5-L/P01	8051398	8051399	8051400	
		8	30V	2A	PUR	BK	•	AL-WAKS8-L/S370	8046990	8046991	8046992	
				2A	PVC	GY	•	AL-WAKS8-L/P01	8051410	8051411	8051412	
				2A	PVC	GY		AL-WAKS8-L/P00	8051200	8051201	8051202	
		12	30V	1,5A	PUR	BK	•	AL-WAKS12-L/S370	8047001	8047002	8047003	
				1,5A	PVC	GY	•	AL-WAKS12-L/P01	8051422	8051423	8051424	
				1,5A	PVC	GY		AL-WAKS12-L/P00	8051212	8051213	8051214	
	Anschlussleitung Kupplung, M12x1, gewinkelt geschirmt	3	250V	4A	PUR	BK	•	AL-WWAKS3-L/S370	8046220	8046221	8046222	
				4A	PVC	GY	•	AL-WWAKS3-L/P01	8051377	8051378	8051379	
				4A	PVC	GY		AL-WWAKS3-L/P00	8051167	8051168	8051169	
		4	250V	4A	PUR	BK	•	AL-WWAKS4-L/S370	8046232	8045279	8045280	
				4A	PVC	GY	•	AL-WWAKS4-L/P01	8051389	8051390	8051391	
				4A	PVC	GY		AL-WWAKS4-L/P00	8051179	8051180	8051181	
		5	60V	4A	PUR	BK	•	AL-WWAKS4.5-L/S370	8045558	8046242	8046243	
				4A	PVC	GY	•	AL-WWAKS4.5-L/P01	8051401	8051402	8051403	
				4A	PVC	GY		AL-WWAKS4.5-L/P00	8051191	8051192	8051193	
		8	30V	2A	PUR	BK	•	AL-WWAKS8-L/S370	8046993	8046994	8046995	
				2A	PVC	GY	•	AL-WWAKS8-L/P01	8051413	8051414	8051415	
				2A	PVC	GY		AL-WWAKS8-L/P00	8051203	8051204	8051205	
		12	30V	1,5A	PUR	BK	•	AL-WWAKS12-L/S370	8047004	8047005	8047006	
				1,5A	PVC	GY	•	AL-WWAKS12-L/P01	8051425	8051426	8051427	
				1,5A	PVC	GY		AL-WWAKS12-L/P00	8051216	8051217	8051218	



* Unsere Standardleitungslängen sind 2m, 5m oder 10m für Anschlussleitungen und 1m, 2m oder 5m für Verbindungsleitungen. Die Litzenlänge bei Flanschen beträgt 0,5m (POWER 0,2m). Alle anderen Leitungs- und Litzenlängen liefern wir Ihnen gern auf Anfrage.

		Kopf				Leitung			Artikelbezeichnung	L = Leitungslänge*		
		Pol	U[max]	I[max]	LED	Material	Farbe	UL		2m / 1m	5m / 2m	10m / 5m
	Anschlussleitung Stecker, M12x1, axial geschirmt	3	250V	4A	PUR	BK	•	AL-WASS3-L/S370	8046223	8046224	8046225	
				4A	PVC	GY	•	AL-WASS3-L/P01	8051380	8051381	8051382	
				4A	PVC	GY		AL-WASS3-L/P00	8051170	8051171	8051172	
		4	250V	4A	PUR	BK	•	AL-WASS4-L/S370	8046233	8046234	8046235	
				4A	PVC	GY	•	AL-WASS4-L/P01	8051392	8051393	8051394	
				4A	PVC	GY		AL-WASS4-L/P00	8051182	8051183	8051184	
		5	60V	4A	PUR	BK	•	AL-WASS4.5-L/S370	8045559	8046244	8046245	
				4A	PVC	GY	•	AL-WASS4.5-L/P01	8051404	8051405	8051406	
				4A	PVC	GY		AL-WASS4.5-L/P00	8051194	8051195	8051196	
		8	30V	2A	PUR	BK	•	AL-WASS8-L/S370	8046807	8046996	8046997	
				2A	PVC	GY	•	AL-WASS8-L/P01	8051416	8051417	8051418	
				2A	PVC	GY		AL-WASS8-L/P00	8051206	8051207	8051208	
		12	30V	1,5A	PUR	BK	•	AL-WASS12-L/S370	8047007	8047008	8047009	
				1,5A	PVC	GY	•	AL-WASS12-L/P01	8051428	8051429	8051430	
				1,5A	PVC	GY		AL-WASS12-L/P00	8051219	8051220	8051221	
	Anschlussleitung Stecker, M12x1, gewinkelt geschirmt	3	250V	4A	PUR	BK	•	AL-WWASS3-L/S370	8046226	8046227	8046228	
				4A	PVC	GY	•	AL-WWASS3-L/P01	8051383	8051384	8051385	
				4A	PVC	GY		AL-WWASS3-L/P00	8051173	8051174	8051175	
		4	250V	4A	PUR	BK	•	AL-WWASS4-L/S370	8046236	8046237	8046238	
				4A	PVC	GY	•	AL-WWASS4-L/P01	8051395	8051396	8051397	
				4A	PVC	GY		AL-WWASS4-L/P00	8051185	8051186	8051187	
		5	60V	4A	PUR	BK	•	AL-WWASS4.5-L/S370	8045560	8044617	8044618	
				4A	PVC	GY	•	AL-WWASS4.5-L/P01	8051407	8051408	8051409	
				4A	PVC	GY		AL-WWASS4.5-L/P00	8051198	8051197	8051199	
		8	30V	2A	PUR	BK	•	AL-WWASS8-L/S370	8046998	8046999	8047000	
				2A	PVC	GY	•	AL-WWASS8-L/P01	8051419	8051420	8051421	
				2A	PVC	GY		AL-WWASS8-L/P00	8051209	8051210	8051211	
		12	30V	1,5A	PUR	BK	•	AL-WWASS12-L/S370	8047010	8047011	8047012	
				1,5A	PVC	GY	•	AL-WWASS12-L/P01	8051431	8051432	8051433	
				1,5A	PVC	GY		AL-WWASS12-L/P00	8051222	8051223	8051224	



* Unsere Standardleitungslängen sind 2m, 5m oder 10m für Anschlussleitungen und 1m, 2m oder 5m für Verbindungsleitungen. Die Litzenlänge bei Flanschen beträgt 0,5m (POWER 0,2m). Alle anderen Leitungs- und Litzenlängen liefern wir Ihnen gern auf Anfrage.

		Kopf				Leitung			Artikelbezeichnung	L = Leitungslänge*		
		Pol	U[max]	I[max]	LED	Material	Farbe	UL		2m / 1m	5m / 2m	10m / 5m
 Verbindungsleitung Kupplung, M12x1, axial Stecker, M12x1, axial geschirmt	3	250V	4A	PUR	BK	•	AL-WAKS3-L-AL-WASS3/S370	8051886	8046270	8046271		
			4A	PVC	GY	•	AL-WAKS3-L-AL-WASS3/P01	8051790	8051791	8051792		
			4A	PVC	GY		AL-WAKS3-L-AL-WASS3/P00	8051582	8051583	8051584		
	4	250V	4A	PUR	BK	•	AL-WAKS4-L-AL-WASS4/S370	8048241	8046282	8046283		
			4A	PVC	GY	•	AL-WAKS4-L-AL-WASS4/P01	8051802	8051803	8051804		
			4A	PVC	GY		AL-WAKS4-L-AL-WASS4/P00	8051594	8051595	8051596		
	5	60V	4A	PUR	BK	•	AL-WAKS4.5-L-AL-WASS4.5/S370	8047973	8046294	8046295		
			4A	PVC	GY	•	AL-WAKS4.5-L-AL-WASS4.5/P01	8051814	8051815	8051816		
			4A	PVC	GY		AL-WAKS4.5-L-AL-WASS4.5/P00	8051606	8051607	8051608		
	8	30V	2A	PUR	BK	•	AL-WAKS8-L-AL-WASS8/S370	8051887	8046968	8047013		
			2A	PVC	GY	•	AL-WAKS8-L-AL-WASS8/P01	8051826	8051827	8051828		
			2A	PVC	GY		AL-WAKS8-L-AL-WASS8/P00	8051618	8051619	8051620		
12	30V	1,5A	PUR	BK	•	AL-WAKS12-L-AL-WASS12/S370	8051888	8047024	8047025			
		1,5A	PVC	GY	•	AL-WAKS12-L-AL-WASS12/P01	8051838	8051839	8051840			
		1,5A	PVC	GY		AL-WAKS12-L-AL-WASS12/P00	8051630	8051631	8051632			
 Verbindungsleitung Kupplung, M12x1, axial Stecker, M12x1, gewinkelt geschirmt	3	250V	4A	PUR	BK	•	AL-WAKS3-L-AL-WWASS3/S370	8051889	8046276	8046277		
			4A	PVC	GY	•	AL-WAKS3-L-AL-WWASS3/P01	8051796	8051797	8051798		
			4A	PVC	GY		AL-WAKS3-L-AL-WWASS3/P00	8051588	8051589	8051590		
	4	250V	4A	PUR	BK	•	AL-WAKS4-L-AL-WWASS4/S370	8048802	8046288	8046289		
			4A	PVC	GY	•	AL-WAKS4-L-AL-WWASS4/P01	8051808	8051809	8051810		
			4A	PVC	GY		AL-WAKS4-L-AL-WWASS4/P00	8051600	8051601	8051602		
	5	60V	4A	PUR	BK	•	AL-WAKS4.5-L-AL-WWASS4.5/S370	8051890	8046300	8046301		
			4A	PVC	GY	•	AL-WAKS4.5-L-AL-WWASS4.5/P01	8051820	8051821	8051822		
			4A	PVC	GY		AL-WAKS4.5-L-AL-WWASS4.5/P00	8051612	8051613	8051614		
	8	30V	2A	PUR	BK	•	AL-WAKS8-L-AL-WWASS8/S370	8051891	8047018	8047019		
			2A	PVC	GY	•	AL-WAKS8-L-AL-WWASS8/P01	8051832	8051833	8051834		
			2A	PVC	GY		AL-WAKS8-L-AL-WWASS8/P00	8051624	8051625	8051626		
	12	30V	1,5A	PUR	BK	•	AL-WAKS12-L-AL-WWASS12/S370	8051892	8047030	8047031		
			1,5A	PVC	GY	•	AL-WAKS12-L-AL-WWASS12/P01	8051844	8051845	8051846		
			1,5A	PVC	GY		AL-WAKS12-L-AL-WWASS12/P00	8051636	8051637	8051638		



* Unsere Standardleitungslängen sind 2m, 5m oder 10m für Anschlussleitungen und 1m, 2m oder 5m für Verbindungsleitungen. Die Litzenlänge bei Flanschen beträgt 0,5m (POWER 0,2m). Alle anderen Leitungs- und Litzenlängen liefern wir Ihnen gern auf Anfrage.

		Kopf				Leitung			Artikelbezeichnung	L = Leitungslänge*		
		Pol	U[max]	I[max]	LED	Material	Farbe	UL		2m / 1m	5m / 2m	10m / 5m
	Verbindungsleitung Kupplung, M12x1, gewinkelt Stecker, M12x1, axial geschirmt	3	250V	4A		PUR	BK	•	AL-WWAKS3-L-AL-WASS3/S370	8051904	8046279	8046280
				4A		PVC	GY	•	AL-WWAKS3-L-AL-WASS3/P01	8051799	8051800	8051801
				4A		PVC	GY		AL-WWAKS3-L-AL-WASS3/P00	8051591	8051592	8051593
		4	250V	4A		PUR	BK	•	AL-WWAKS4-L-AL-WASS4/S370	8049426	8046291	8046292
				4A		PVC	GY	•	AL-WWAKS4-L-AL-WASS4/P01	8051811	8051812	8051813
				4A		PVC	GY		AL-WWAKS4-L-AL-WASS4/P00	8051603	8051604	8051605
		5	60V	4A		PUR	BK	•	AL-WWAKS4.5-L-AL-WASS4.5/S370	8051897	8046303	8046304
				4A		PVC	GY	•	AL-WWAKS4.5-L-AL-WASS4.5/P01	8051823	8051824	8051825
				4A		PVC	GY		AL-WWAKS4.5-L-AL-WASS4.5/P00	8051615	8051616	8051617
		8	30V	2A		PUR	BK	•	AL-WWAKS8-L-AL-WASS8/S370	8051898	8047021	8047022
				2A		PVC	GY	•	AL-WWAKS8-L-AL-WASS8/P01	8051835	8051836	8051837
				2A		PVC	GY		AL-WWAKS8-L-AL-WASS8/P00	8051627	8051628	8051629
12	30V	1,5A		PUR	BK	•	AL-WWAKS12-L-AL-WASS12/S370	8051899	8047033	8047034		
		1,5A		PVC	GY	•	AL-WWAKS12-L-AL-WASS12/P01	8051847	8051848	8051849		
		1,5A		PVC	GY		AL-WWAKS12-L-AL-WASS12/P00	8051639	8051640	8051641		
	Verbindungsleitung Kupplung, M12x1, gewinkelt Stecker, M12x1, gewinkelt geschirmt	3	250V	4A		PUR	BK	•	AL-WWAKS3-L-AL-WWASS3/S370	8051900	8046273	8046274
				4A		PVC	GY		AL-WWAKS3-L-AL-WWASS3/P00	8051585	8051586	8051587
				4A		PVC	GY	•	AL-WWAKS3-L-AL-WWASS3/P01	8051793	8051794	8051795
		4	250V	4A		PUR	BK	•	AL-WWAKS4-L-AL-WWASS4/S370	8051901	8046285	8046286
				4A		PVC	GY	•	AL-WWAKS4-L-AL-WWASS4/P01	8051805	8051806	8051807
				4A		PVC	GY		AL-WWAKS4-L-AL-WWASS4/P00	8051597	8051598	8051599
		5	60V	4A		PUR	BK	•	AL-WWAKS4.5-L-AL-WWASS4.5/S370	8051902	8046297	8046298
				4A		PVC	GY	•	AL-WWAKS4.5-L-AL-WWASS4.5/P01	8051817	8051818	8051819
				4A		PVC	GY		AL-WWAKS4.5-L-AL-WWASS4.5/P00	8051609	8051610	8051611
		8	30V	2A		PUR	BK	•	AL-WWAKS8-L-AL-WWASS8/S370	8048908	8047015	8047016
				2A		PVC	GY	•	AL-WWAKS8-L-AL-WWASS8/P01	8051829	8051830	8051831
				2A		PVC	GY		AL-WWAKS8-L-AL-WWASS8/P00	8051621	8051622	8051623
		12	30V	1,5A		PUR	BK	•	AL-WWAKS12-L-AL-WWASS12/S370	8051903	8047027	8047028
				1,5A		PVC	GY	•	AL-WWAKS12-L-AL-WWASS12/P01	8051841	8051842	8051843
				1,5A		PVC	GY		AL-WWAKS12-L-AL-WWASS12/P00	8051633	8051634	8051635



* Unsere Standardleitungslängen sind 2m, 5m oder 10m für Anschlussleitungen und 1m, 2m oder 5m für Verbindungsleitungen. Die Litzenlänge bei Flanschen beträgt 0,5m (POWER 0,2m). Alle anderen Leitungs- und Litzenlängen liefern wir Ihnen gern auf Anfrage.

		Kopf				Leitung			Artikelbezeichnung	L = Leitungslänge*		
		Pol	U[max]	I[max]	LED	Material	Farbe	UL		2m / 1m	5m / 2m	10m / 5m
	Anschlussleitung Kupplung, M8x1, axial	3	60V	4A	PUR	BK	•	AL-SKP3-L/S370	8043748	8043749	8043750	
				4A	PUR	BK	•	AL-SKP3-L/S400	8075430	8075431	8075432	
				4A	PUR	GY	•	AL-SKP3-L/S370GY	8059110	8059111	8059112	
				4A	PUR	OG	•	AL-SKP3-L/S7400	8059113	8059114	8059115	
				4A	PVC	BK	•	AL-SKP3-L/P01BK	8081823	8081824	8081825	
				4A	PVC	GY	•	AL-SKP3-L/P01	8051226	8051227	8051228	
				4A	PVC	GY		AL-SKP3-L/P00	8048639	8048640	8048641	
		4	60V	4A	PUR	BK	•	AL-SKP4-L/S370	8043760	8043761	8043762	
				4A	PUR	BK	•	AL-SKP4-L/S400	8075445	8075446	8075447	
				4A	PUR	GY	•	AL-SKP4-L/S370GY	8067754	8067755	8067756	
				4A	PUR	OG	•	AL-SKP4-L/S7400	8066417	8067456	8067457	
				4A	PVC	BK	•	AL-SKP4-L/P01BK	8081835	8081836	8081837	
				4A	PVC	GY	•	AL-SKP4-L/P01	8051238	8051239	8051240	
				4A	PVC	GY		AL-SKP4-L/P00	8048645	8048646	8048647	
5	30V	3A	PUR	BK	•	AL-SKP4.5-L/S370	8051859	8051858	8051860			
		3A	PUR	BK	•	AL-SKP4.5-L/S400	8075460	8075461	8075462			
		3A	PVC	GY		AL-SKP4.5-L/P00	8047045	8051850	8051851			
	Anschlussleitung Kupplung, M8x1, gewinkelt	3	60V	4A	PUR	BK	•	AL-SWKP3-L/S370	8043751	8043752	8043753	
				4A	PUR	BK	•	AL-SWKP3-L/S400	8075436	8075437	8075438	
				4A	PUR	GY	•	AL-SWKP3-L/S370GY	8059116	8059117	8059118	
				4A	PUR	OG	•	AL-SWKP3-L/S7400	8059119	8059120	8059121	
				4A	PVC	BK	•	AL-SWKP3-L/P01BK	8081826	8081827	8081828	
				4A	PVC	GY	•	AL-SWKP3-L/P01	8051229	8051230	8051231	
				4A	PVC	GY		AL-SWKP3-L/P00	8048642	8048643	8048644	
		4	60V	4A	PUR	BK	•	AL-SWKP4-L/S370	8043763	8043764	8043765	
				4A	PUR	BK	•	AL-SWKP4-L/S400	8075451	8075452	8075453	
				4A	PUR	GY	•	AL-SWKP4-L/S370GY	8067770	8067774	8067775	
				4A	PUR	OG	•	AL-SWKP4-L/S7400	8067467	8067468	8067469	
				4A	PVC	BK	•	AL-SWKP4-L/P01BK	8081838	8081839	8081840	
				4A	PVC	GY	•	AL-SWKP4-L/P01	8051241	8051242	8051243	
				4A	PVC	GY		AL-SWKP4-L/P00	8048648	8048649	8048650	
5	30V	3A	PUR	BK	•	AL-SWKP4.5-L/S370	8051861	8051862	8051863			
		3A	PUR	BK	•	AL-SWKP4.5-L/S400	8075466	8075467	8075468			
		3A	PVC	GY		AL-SWKP4.5-L/P00	8047049	8051852	8051853			



* Unsere Standardleitungslängen sind 2m, 5m oder 10m für Anschlussleitungen und 1m, 2m oder 5m für Verbindungsleitungen. Die Litzenlänge bei Flanschen beträgt 0,5m (POWER 0,2m). Alle anderen Leitungs- und Litzenlängen liefern wir Ihnen gern auf Anfrage.

		Kopf				Leitung			Artikelbezeichnung	L = Leitungslänge*		
		Pol	U[max]	I[max]	LED	Material	Farbe	UL		2m / 1m	5m / 2m	10m / 5m
	Anschlussleitung Kupplung, M8x1, gewinkelt, mit LED	3	30V	3A	3P2	PUR	BK	•	AL-SWKP3P2-L/S370	8045344	8045419	8045420
				3A	3P2	PUR	BK	•	AL-SWKP3P2-L/S400	8075439	8075440	8075441
				3A	3P2	PUR	GY	•	AL-SWKP3P2-L/S370GY	8059122	8059123	8059124
				3A	3P2	PUR	OG	•	AL-SWKP3P2-L/S7400	8059125	8059126	8059127
				3A	3P2	PVC	BK	•	AL-SWKP3P2-L/P01BK	8081883	8081884	8081885
				3A	3P2	PVC	GY	•	AL-SWKP3P2-L/P01	8051322	8051323	8051324
				3A	3P2	PVC	GY		AL-SWKP3P2-L/P00	8051113	8051114	8051115
		4	30V	3A	4P2	PUR	BK	•	AL-SWKP4P2-L/S370	8045345	8045421	8045422
				3A	4P2	PUR	BK	•	AL-SWKP4P2-L/S400	8075454	8075455	8075456
				3A	4P2	PUR	GY	•	AL-SWKP4P2-L/S370GY	8067809	8067810	8067811
				3A	4P2	PUR	OG	•	AL-SWKP4P2-L/S7400	8067532	8067533	8067534
				3A	4P2	PVC	BK	•	AL-SWKP4P2-L/P01BK	8081886	8081887	8081888
				3A	4P2	PVC	GY	•	AL-SWKP4P2-L/P01	8051325	8051326	8051327
				3A	4P2	PVC	GY		AL-SWKP4P2-L/P00	8051116	8051117	8051118
	Anschlussleitung Stecker, M8x1, axial	3	60V	4A		PUR	BK	•	AL-SSP3-L/S370	8043754	8043755	8043756
				4A		PUR	BK	•	AL-SSP3-L/S400	8075433	8075434	8075435
				4A		PUR	GY	•	AL-SSP3-L/S370GY	8059152	8059153	8059154
				4A		PUR	OG	•	AL-SSP3-L/S7400	8059155	8059156	8059157
				4A		PVC	BK	•	AL-SSP3-L/P01BK	8081829	8081830	8081831
				4A		PVC	GY	•	AL-SSP3-L/P01	8051232	8051233	8051234
				4A		PVC	GY		AL-SSP3-L/P00	8051031	8051032	8051033
		4	60V	4A		PUR	BK	•	AL-SSP4-L/S370	8043766	8043767	8043768
				4A		PUR	BK	•	AL-SSP4-L/S400	8075448	8075449	8075450
				4A		PUR	GY	•	AL-SSP4-L/S370GY	8067758	8067760	8067762
				4A		PUR	OG	•	AL-SSP4-L/S7400	8067458	8067460	8067461
				4A		PVC	BK	•	AL-SSP4-L/P01BK	8081841	8081842	8081843
				4A		PVC	GY	•	AL-SSP4-L/P01	8051244	8051245	8051246
				4A		PVC	GY		AL-SSP4-L/P00	8051037	8051038	8051039
5	30V	3A		PUR	BK	•	AL-SSP4.5-L/S370	8050052	8050053	8050054		
		3A		PUR	BK	•	AL-SSP4.5-L/S400	8075463	8075464	8075465		
		3A		PVC	GY		AL-SSP4.5-L/P00	8047066	8050044	8050045		



* Unsere Standardleitungslängen sind 2m, 5m oder 10m für Anschlussleitungen und 1m, 2m oder 5m für Verbindungsleitungen. Die Litzenlänge bei Flanschen beträgt 0,5m (POWER 0,2m). Alle anderen Leitungs- und Litzenlängen liefern wir Ihnen gern auf Anfrage.

		Kopf				Leitung			Artikelbezeichnung	L = Leitungslänge*		
		Pol	U[max]	I[max]	LED	Material	Farbe	UL		2m / 1m	5m / 2m	10m / 5m
	Anschlussleitung Stecker, M8x1, gewinkelt	3	60V	4A	PUR	BK	•	AL-SWSP3-L/S370	8043757	8043758	8043759	
				4A	PUR	BK	•	AL-SWSP3-L/S400	8075442	8075443	8075444	
				4A	PUR	GY	•	AL-SWSP3-L/S370GY	8059158	8059159	8059160	
				4A	PUR	OG	•	AL-SWSP3-L/S7400	8059161	8059162	8059163	
				4A	PVC	BK	•	AL-SWSP3-L/P01BK	8081832	8081833	8081834	
				4A	PVC	GY	•	AL-SWSP3-L/P01	8051235	8051236	8051237	
				4A	PVC	GY		AL-SWSP3-L/P00	8051034	8051035	8051036	
		4	60V	4A	PUR	BK	•	AL-SWSP4-L/S370	8043769	8043770	8043771	
				4A	PUR	BK	•	AL-SWSP4-L/S400	8075457	8075458	8075459	
				4A	PUR	GY	•	AL-SWSP4-L/S370GY	8067763	8067764	8067768	
				4A	PUR	OG	•	AL-SWSP4-L/S7400	8067462	8067463	8067464	
				4A	PVC	BK	•	AL-SWSP4-L/P01BK	8081844	8081845	8081846	
				4A	PVC	GY	•	AL-SWSP4-L/P01	8051247	8051248	8051249	
				4A	PVC	GY		AL-SWSP4-L/P00	8051040	8051041	8051042	
5	30V	3A	PUR	BK	•	AL-SWSP4.5-L/S370	8050055	8050056	8050057			
		3A	PUR	BK	•	AL-SWSP4.5-L/S400	8075469	8075470	8075471			
		3A	PVC	GY		AL-SWSP4.5-L/P00	8047050	8050046	8050047			
	Verbindungsleitung Kupplung, M8x1, axial Stecker, M8x1, axial	3	60V	4A	PUR	BK	•	AL-SKP3-L-AL-SSP3/S370	8044811	8044002	8044003	
				4A	PUR	GY	•	AL-SKP3-L-AL-SSP3/S370GY	8059176	8059177	8059178	
				4A	PUR	OG	•	AL-SKP3-L-AL-SSP3/S7400	8059179	8059180	8059181	
				4A	PVC	BK	•	AL-SKP3-L-AL-SSP3/P01BK	8081927	8081928	8081929	
				4A	PVC	GY	•	AL-SKP3-L-AL-SSP3/P01	8051642	8051643	8051644	
				4A	PVC	GY		AL-SKP3-L-AL-SSP3/P00	8051434	8051435	8051436	
		4	60V	4A	PUR	BK	•	AL-SKP4-L-AL-SSP4/S370	8045944	8044017	8044018	
				4A	PUR	GY	•	AL-SKP4-L-AL-SSP4/S370GY	8067813	8067904	8067909	
				4A	PUR	OG	•	AL-SKP4-L-AL-SSP4/S7400	8067535	8067537	8067549	
				4A	PVC	BK	•	AL-SKP4-L-AL-SSP4/P01BK	8081940	8081941	8081942	
				4A	PVC	GY	•	AL-SKP4-L-AL-SSP4/P01	8051655	8051656	8051657	
				4A	PVC	GY		AL-SKP4-L-AL-SSP4/P00	8051447	8051448	8051449	
		5	30V	3A	PUR	BK	•	AL-SKP4.5-L-AL-SSP4.5/S370	8052755	8052756	8052757	
				3A	PVC	GY		AL-SKP4.5-L-AL-SSP4.5/P00	8052860	8042846	8042848	



* Unsere Standardleitungslängen sind 2m, 5m oder 10m für Anschlussleitungen und 1m, 2m oder 5m für Verbindungsleitungen. Die Litzenlänge bei Flanschen beträgt 0,5m (POWER 0,2m). Alle anderen Leitungs- und Litzenlängen liefern wir Ihnen gern auf Anfrage.

		Kopf				Leitung			Artikelbezeichnung	L = Leitungslänge*		
		Pol	U[max]	I[max]	LED	Material	Farbe	UL		2m / 1m	5m / 2m	10m / 5m
	Verbindungsleitung Kupplung, M8x1, axial Stecker, M8x1, gewinkelt	3	60V	4A	PUR	BK	•	AL-SKP3-L-AL-SWSP3/S370	8051913	8044011	8044012	
				4A	PUR	GY	•	AL-SKP3-L-AL-SWSP3/S370GY	8059182	8059183	8059184	
				4A	PUR	OG	•	AL-SKP3-L-AL-SWSP3/S7400	8059185	8059186	8059188	
				4A	PVC	BK	•	AL-SKP3-L-AL-SWSP3/P01BK	8081933	8081934	8081936	
				4A	PVC	GY	•	AL-SKP3-L-AL-SWSP3/P01	8051649	8051650	8051651	
				4A	PVC	GY		AL-SKP3-L-AL-SWSP3/P00	8051440	8051441	8051442	
	4	60V	4A	PUR	BK	•	AL-SKP4-L-AL-SWSP4/S370	8046587	8044023	8044024		
			4A	PUR	GY	•	AL-SKP4-L-AL-SWSP4/S370GY	8067914	8067915	8067917		
			4A	PUR	OG	•	AL-SKP4-L-AL-SWSP4/S7400	8067559	8067560	8067633		
			4A	PVC	BK	•	AL-SKP4-L-AL-SWSP4/P01BK	8081946	8081947	8081948		
			4A	PVC	GY	•	AL-SKP4-L-AL-SWSP4/P01	8051661	8051662	8051663		
			4A	PVC	GY		AL-SKP4-L-AL-SWSP4/P00	8051453	8051454	8051455		
5	30V	3A	PUR	BK	•	AL-SKP4.5-L-AL-SWSP4.5/S370	8052764	8052765	8052766			
		3A	PVC	GY		AL-SKP4.5-L-AL-SWSP4.5/P00	8042859	8042860	8042861			
	Verbindungsleitung Kupplung, M8x1, gewinkelt Stecker, M8x1, axial	3	60V	4A	PUR	BK	•	AL-SWKP3-L-AL-SSP3/S370	8044842	8044014	8044015	
				4A	PUR	GY	•	AL-SWKP3-L-AL-SSP3/S370GY	8059189	8059190	8059191	
				4A	PUR	OG	•	AL-SWKP3-L-AL-SSP3/S7400	8059192	8059193	8059194	
				4A	PVC	BK	•	AL-SWKP3-L-AL-SSP3/P01BK	8081937	8081938	8081939	
				4A	PVC	GY	•	AL-SWKP3-L-AL-SSP3/P01	8051652	8051653	8051654	
				4A	PVC	GY		AL-SWKP3-L-AL-SSP3/P00	8051444	8051445	8051446	
	4	60V	4A	PUR	BK	•	AL-SWKP4-L-AL-SSP4/S370	8046576	8044026	8044027		
			4A	PUR	GY	•	AL-SWKP4-L-AL-SSP4/S370GY	8067918	8067920	8067967		
			4A	PUR	OG	•	AL-SWKP4-L-AL-SSP4/S7400	8067634	8067641	8067648		
			4A	PVC	BK	•	AL-SWKP4-L-AL-SSP4/P01BK	8081949	8081950	8081951		
			4A	PVC	GY	•	AL-SWKP4-L-AL-SSP4/P01	8051664	8051665	8051666		
			4A	PVC	GY		AL-SWKP4-L-AL-SSP4/P00	8051456	8051457	8051458		
5	30V	3A	PUR	BK	•	AL-SWKP4.5-L-AL-SSP4.5/S370	8052761	8052762	8052763			
		3A	PVC	GY		AL-SWKP4.5-L-AL-SSP4.5/P00	8042855	8050039	8042857			



* Unsere Standardleitungslängen sind 2m, 5m oder 10m für Anschlussleitungen und 1m, 2m oder 5m für Verbindungsleitungen. Die Litzenlänge bei Flanschen beträgt 0,5m (POWER 0,2m). Alle anderen Leitungs- und Litzenlängen liefern wir Ihnen gern auf Anfrage.

		Kopf				Leitung			Artikelbezeichnung	L = Leitungslänge*			
		Pol	U[max]	I[max]	LED	Material	Farbe	UL		2m / 1m	5m / 2m	10m / 5m	
	Verbindungsleitung Kupplung, M8x1, gewinkelt Stecker, M8x1, gewinkelt	3	60V	4A		PUR	BK	•	AL-SWKP3-L-AL-SWSP3/S370	8046572	8044008	8044009	
				4A		PUR	GY	•	AL-SWKP3-L-AL-SWSP3/S370GY	8059195	8059196	8059197	
				4A		PUR	OG	•	AL-SWKP3-L-AL-SWSP3/S7400	8059198	8059199	8059200	
				4A		PVC	BK	•	AL-SWKP3-L-AL-SWSP3/P01BK	8081930	8081931	8081932	
				4A		PVC	GY	•	AL-SWKP3-L-AL-SWSP3/P01	8051646	8051647	8051648	
				4A		PVC	GY		AL-SWKP3-L-AL-SWSP3/P00	8051437	8051438	8051439	
		4	60V	4A		PUR	BK	•	AL-SWKP4-L-AL-SWSP4/S370	8046573	8044020	8044021	
				4A		PUR	GY	•	AL-SWKP4-L-AL-SWSP4/S370GY	8067910	8067912	8067913	
				4A		PUR	OG	•	AL-SWKP4-L-AL-SWSP4/S7400	8067554	8067555	8067556	
				4A		PVC	BK	•	AL-SWKP4-L-AL-SWSP4/P01BK	8081943	8081944	8081945	
				4A		PVC	GY	•	AL-SWKP4-L-AL-SWSP4/P01	8051658	8051659	8051660	
				4A		PVC	GY		AL-SWKP4-L-AL-SWSP4/P00	8051450	8051451	8051452	
5	30V	3A		PUR	BK	•	AL-SWKP4.5-L-AL-SWSP4.5/S370	8052758	8052759	8052760			
		3A		PVC	GY		AL-SWKP4.5-L-AL-SWSP4.5/P00	8042850	8050038	8042852			
	Verbindungsleitung Kupplung, M8x1, gewinkelt, mit LED Stecker, M8x1, axial	3	30V	3A	3P2	PUR	BK	•	AL-SWKP3P2-L-AL-SSP3/S370	8047130	8045932	8045933	
				3A	3P2	PUR	GY	•	AL-SWKP3P2-L-AL-SSP3/S370GY	8059201	8059202	8059203	
				3A	3P2	PUR	OG	•	AL-SWKP3P2-L-AL-SSP3/S7400	8059204	8059205	8059206	
				3A	3P2	PVC	BK	•	AL-SWKP3P2-L-AL-SSP3/P01BK	8082071	8082072	8082073	
				3A	3P2	PVC	GY	•	AL-SWKP3P2-L-AL-SSP3/P01	8051739	8051740	8051741	
				3A	3P2	PVC	GY		AL-SWKP3P2-L-AL-SSP3/P00	8051531	8051532	8051533	
		4	30V	3A	4P2	PUR	BK	•	AL-SWKP4P2-L-AL-SSP4/S370	8049863	8045935	8045936	
				3A	4P2	PUR	GY	•	AL-SWKP4P2-L-AL-SSP4/S370GY	8067968	8067969	8067970	
				3A	4P2	PUR	OG	•	AL-SWKP4P2-L-AL-SSP4/S7400	8067649	8067703	8067704	
				3A	4P2	PVC	BK	•	AL-SWKP4P2-L-AL-SSP4/P01BK	8081988	8081989	8081990	
				3A	4P2	PVC	GY	•	AL-SWKP4P2-L-AL-SSP4/P01	8051742	8051743	8051744	
				3A	4P2	PVC	GY		AL-SWKP4P2-L-AL-SSP4/P00	8051534	8051535	8051536	
	Anschlussleitung Kupplung, M8x1, axial geschirmt	3	60V	4A		PUR	BK	•	AL-SKPS3-L/S370	8046192	8046193	8046194	
				4A		PVC	GY	•	AL-SKPS3-L/P01	8051349	8051350	8051351	
				4A		PVC	GY		AL-SKPS3-L/P00	8051140	8051141	8051142	
		4		60V	4A		PUR	BK	•	AL-SKPS4-L/S370	8046204	8046205	8046206
					4A		PVC	GY	•	AL-SKPS4-L/P01	8051362	8051363	8051364
					4A		PVC	GY		AL-SKPS4-L/P00	8051152	8051153	8051154
		5	30V	3A		PUR	BK	•	AL-SKPS4.5-L/S370	8047058	8051864	8051865	
				3A		PVC	GY		AL-SKPS4.5-L/P00	8047046	8051854	8051855	



* Unsere Standardleitungslängen sind 2m, 5m oder 10m für Anschlussleitungen und 1m, 2m oder 5m für Verbindungsleitungen. Die Litzenlänge bei Flanschen beträgt 0,5m (POWER 0,2m). Alle anderen Leitungs- und Litzenlängen liefern wir Ihnen gern auf Anfrage.

		Kopf				Leitung			Artikelbezeichnung	L = Leitungslänge*		
		Pol	U[max]	I[max]	LED	Material	Farbe	UL		2m / 1m	5m / 2m	10m / 5m
	Anschlussleitung Kupplung, M8x1, gewinkelt geschirmt	3	60V	4A	PUR	BK	•	AL-SWKPS3-L/S370	8046195	8046196	8046197	
				4A	PVC	GY	•	AL-SWKPS3-L/P01	8051353	8051354	8051355	
				4A	PVC	GY		AL-SWKPS3-L/P00	8051143	8051144	8051145	
		4	60V	4A	PUR	BK	•	AL-SWKPS4-L/S370	8046207	8046208	8046209	
				4A	PVC	GY	•	AL-SWKPS4-L/P01	8051365	8051366	8051367	
				4A	PVC	GY		AL-SWKPS4-L/P00	8051155	8051156	8051157	
		5	30V	3A	PUR	BK	•	AL-SWKPS4.5-L/S370	8047060	8051866	8051867	
				3A	PVC	GY		AL-SWKPS4.5-L/P00	8047051	8051856	8051857	
			Anschlussleitung Stecker, M8x1, axial geschirmt	3	60V	4A	PUR	BK	•	AL-SSPS3-L/S370	8046198	8046199
4A	PVC					GY	•	AL-SSPS3-L/P01	8051356	8051357	8051358	
4A	PVC					GY		AL-SSPS3-L/P00	8051146	8051147	8051148	
4	60V			4A	PUR	BK	•	AL-SSPS4-L/S370	8046210	8046211	8046212	
				4A	PVC	GY	•	AL-SSPS4-L/P01	8051368	8051369	8051370	
				4A	PVC	GY		AL-SSPS4-L/P00	8051158	8051159	8051160	
5	30V			3A	PUR	BK	•	AL-SSPS4.5-L/S370	8047061	8050058	8050059	
				3A	PVC	GY		AL-SSPS4.5-L/P00	8047048	8050048	8050049	
	Anschlussleitung Stecker, M8x1, gewinkelt geschirmt			3	60V	4A	PUR	BK	•	AL-SWSPS3-L/S370	8046201	8046202
		4A	PVC			GY	•	AL-SWSPS3-L/P01	8051359	8051360	8051361	
		4A	PVC			GY		AL-SWSPS3-L/P00	8051149	8051150	8051151	
		4	60V	4A	PUR	BK	•	AL-SWSPS4-L/S370	8046214	8046215	8046216	
				4A	PVC	GY	•	AL-SWSPS4-L/P01	8051371	8051372	8051373	
				4A	PVC	GY		AL-SWSPS4-L/P00	8051161	8051162	8051163	
		5	30V	3A	PUR	BK	•	AL-SWSPS4.5-L/S370	8047062	8050060	8050061	
				3A	PVC	GY		AL-SWSPS4.5-L/P00	8047052	8050050	8050051	
			Verbindungsleitung Kupplung, M8x1, axial Stecker, M8x1, axial geschirmt	3	60V	4A	PUR	BK	•	AL-SKPS3-L-AL-SSPS3/S370	8051896	8046246
4A	PVC					GY	•	AL-SKPS3-L-AL-SSPS3/P01	8051766	8051767	8051768	
4A	PVC					GY		AL-SKPS3-L-AL-SSPS3/P00	8051558	8051559	8051560	
4	60V			4A	PUR	BK	•	AL-SKPS4-L-AL-SSPS4/S370	8051914	8046258	8046259	
				4A	PVC	GY	•	AL-SKPS4-L-AL-SSPS4/P01	8051778	8051779	8051780	
				4A	PVC	GY		AL-SKPS4-L-AL-SSPS4/P00	8051570	8051571	8051572	
5	30V			3A	PUR	BK	•	AL-SKPS4.5-L-AL-SSPS4.5/S370	8052768	8052769	8052770	
				3A	PVC	GY		AL-SKPS4.5-L-AL-SSPS4.5/P00	8042863	8042864	8042865	



* Unsere Standardleitungslängen sind 2m, 5m oder 10m für Anschlussleitungen und 1m, 2m oder 5m für Verbindungsleitungen. Die Litzenlänge bei Flanschen beträgt 0,5m (POWER 0,2m). Alle anderen Leitungs- und Litzenlängen liefern wir Ihnen gern auf Anfrage.

		Kopf				Leitung			Artikelbezeichnung	L = Leitungslänge*		
		Pol	U[max]	I[max]	LED	Material	Farbe	UL		2m / 1m	5m / 2m	10m / 5m
	Verbindungsleitung Kupplung, M8x1, axial Stecker, M8x1, gewinkelt geschirmt	3	60V	4A	PUR	BK	•	AL-SKPS3-L-AL-SWSPS3/S370	8051915	8046252	8046253	
				4A	PVC	GY	•	AL-SKPS3-L-AL-SWSPS3/P01	8051772	8051773	8051774	
				4A	PVC	GY		AL-SKPS3-L-AL-SWSPS3/P00	8051564	8051565	8051566	
		4	60V	4A	PUR	BK	•	AL-SKPS4-L-AL-SWSPS4/S370	8051916	8046264	8046265	
				4A	PVC	GY	•	AL-SKPS4-L-AL-SWSPS4/P01	8051784	8051785	8051786	
				4A	PVC	GY		AL-SKPS4-L-AL-SWSPS4/P00	8051576	8051577	8051578	
		5	30V	3A	PUR	BK	•	AL-SKPS4.5-L-AL-SWSPS4.5/S370	8052777	8052778	8052779	
				3A	PVC	GY		AL-SKPS4.5-L-AL-SWSPS4.5/P00	8042876	8042877	8042878	
			Verbindungsleitung Kupplung, M8x1, gewinkelt Stecker, M8x1, axial geschirmt	3	60V	4A	PUR	BK	•	AL-SWKPS3-L-AL-SSPS3/S370	8051917	8046255
4A	PVC					GY	•	AL-SWKPS3-L-AL-SSPS3/P01	8051775	8051776	8051777	
4A	PVC					GY		AL-SWKPS3-L-AL-SSPS3/P00	8051567	8051568	8051569	
4	60V			4A	PUR	BK	•	AL-SWKPS4-L-AL-SSPS4/S370	8051918	8046267	8046268	
				4A	PVC	GY	•	AL-SWKPS4-L-AL-SSPS4/P01	8051787	8051788	8051789	
				4A	PVC	GY		AL-SWKPS4-L-AL-SSPS4/P00	8051579	8051580	8051581	
5	30V			3A	PUR	BK	•	AL-SWKPS4.5-L-AL-SSPS4.5/S370	8052774	8052775	8052776	
				3A	PVC	GY		AL-SWKPS4.5-L-AL-SSPS4.5/P00	8042872	8042873	8042874	
	Verbindungsleitung Kupplung, M8x1, gewinkelt Stecker, M8x1, gewinkelt geschirmt			3	60V	4A	PUR	BK	•	AL-SWKPS3-L-AL-SWSPS3/S370	8051919	8046249
		4A	PVC			GY	•	AL-SWKPS3-L-AL-SWSPS3/P01	8051769	8051770	8051771	
		4A	PVC			GY		AL-SWKPS3-L-AL-SWSPS3/P00	8051561	8051562	8051563	
		4	60V	4A	PUR	BK	•	AL-SWKPS4-L-AL-SWSPS4/S370	8051920	8046261	8046262	
				4A	PVC	GY	•	AL-SWKPS4-L-AL-SWSPS4/P01	8051781	8051782	8051783	
				4A	PVC	GY		AL-SWKPS4-L-AL-SWSPS4/P00	8051573	8051574	8051575	
		5	30V	3A	PUR	BK	•	AL-SWKPS4.5-L-AL-SWSPS4.5/S370	8052771	8052772	8052773	
				3A	PVC	GY		AL-SWKPS4.5-L-AL-SWSPS4.5/P00	8042868	8042869	8042870	



* Unsere Standardleitungslängen sind 2m, 5m oder 10m für Anschlussleitungen und 1m, 2m oder 5m für Verbindungsleitungen. Die Litzenlänge bei Flanschen beträgt 0,5m (POWER 0,2m). Alle anderen Leitungs- und Litzenlängen liefern wir Ihnen gern auf Anfrage.

		Kopf				Leitung			Artikelbezeichnung	L = Leitungslänge*		
		Pol	U[max]	I[max]	LED	Material	Farbe	UL		2m / 1m	5m / 2m	10m / 5m
	Anschlussleitung Kupplung, Ø8mm snap, axial	3	60V	4A	PUR	BK	•	AL-KP3-L/S370	8051894	8044517	8051895	
				4A	PUR	BK	•	AL-KP3-L/S400	8075163	8075164	8075410	
				4A	PUR	GY	•	AL-KP3-L/S370GY	8059128	8059129	8059130	
				4A	PUR	OG	•	AL-KP3-L/S7400	8059131	8059132	8059133	
				4A	PVC	BK	•	AL-KP3-L/P01BK	8082013	8082014	8082015	
				4A	PVC	GY	•	AL-KP3-L/P01	8052493	8052494	8052495	
				4A	PVC	GY		AL-KP3-L/P00	8052490	8052491	8052492	
	4	60V	4A	PUR	BK	•	AL-KP4-L/S370	8043940	8045033	8052669		
			4A	PUR	BK	•	AL-KP4-L/S400	8075181	8075182	8075418		
			4A	PUR	GY	•	AL-KP4-L/S370GY	8067979	8067981	8067982		
			4A	PUR	OG	•	AL-KP4-L/S7400	8067709	8067708	8067710		
			4A	PVC	BK	•	AL-KP4-L/P01BK	8082031	8082032	8082033		
			4A	PVC	GY	•	AL-KP4-L/P01	8052717	8052718	8052719		
			4A	PVC	GY		AL-KP4-L/P00	8052690	8052691	8052692		
5	30V	3A	PUR	BK	•	AL-KP4.5-L/S370	8050016	8050017	8050018			
		3A	PUR	BK	•	AL-KP4.5-L/S400	8075201	8075202	8075424			
		3A	PVC	GY		AL-KP4.5-L/P00	8043847	8050005	8050006			
	Anschlussleitung Kupplung, Ø8mm snap, axial, mit Zugsicherung	3	60V	4A	PUR	BK	•	AL-ZKP3-L/S370	8052680	8052681	8052682	
				4A	PUR	BK	•	AL-ZKP3-L/S400	8075175	8075176	8075416	
				4A	PUR	GY	•	AL-ZKP3-L/S370GY	8059140	8059141	8059142	
				4A	PUR	OG	•	AL-ZKP3-L/S7400	8059143	8059144	8059145	
				4A	PVC	BK	•	AL-ZKP3-L/P01BK	8082046	8082047	8082048	
				4A	PVC	GY	•	AL-ZKP3-L/P01	8052733	8052734	8052735	
				4A	PVC	GY		AL-ZKP3-L/P00	8052705	8052706	8052707	
	4	60V	4A	PUR	BK	•	AL-ZKP4-L/S370	8046076	8051911	8051912		
			4A	PUR	BK	•	AL-ZKP4-L/S400	8075193	8075194	8075422		
			4A	PUR	GY	•	AL-ZKP4-L/S370GY	8068026	8068027	8068028		
			4A	PUR	OG	•	AL-ZKP4-L/S7400	8067747	8067749	8067750		
			4A	PVC	BK	•	AL-ZKP4-L/P01BK	8082049	8082050	8082051		
			4A	PVC	GY	•	AL-ZKP4-L/P01	8052736	8052737	8052738		
			4A	PVC	GY		AL-ZKP4-L/P00	8052708	8052709	8052710		
5	30V	3A	PUR	BK	•	AL-ZKP4.5-L/S370	8050025	8050026	8050027			
		3A	PUR	BK	•	AL-ZKP4.5-L/S400	8075217	8075218	8075428			
		3A	PVC	GY		AL-ZKP4.5-L/P00	8049768	8050009	8050010			



* Unsere Standardleitungslängen sind 2m, 5m oder 10m für Anschlussleitungen und 1m, 2m oder 5m für Verbindungsleitungen. Die Litzenlänge bei Flanschen beträgt 0,5m (POWER 0,2m). Alle anderen Leitungs- und Litzenlängen liefern wir Ihnen gern auf Anfrage.

		Kopf				Leitung			Artikelbezeichnung	L = Leitungslänge*		
		Pol	U[max]	I[max]	LED	Material	Farbe	UL		2m / 1m	5m / 2m	10m / 5m
	Anschlussleitung Kupplung, Ø8mm snap, gewinkelt	3	60V	4A	PUR	BK	•	AL-WKP3-L/S370	8052670	8044518	8052671	
				4A	PUR	BK	•	AL-WKP3-L/S400	8075169	8075170	8075412	
				4A	PUR	GY	•	AL-WKP3-L/S370GY	8059134	8059135	8059136	
				4A	PUR	OG	•	AL-WKP3-L/S7400	8059137	8059138	8059139	
				4A	PVC	BK	•	AL-WKP3-L/P01BK	8082037	8082038	8082039	
				4A	PVC	GY	•	AL-WKP3-L/P01	8052724	8052725	8052726	
				4A	PVC	GY		AL-WKP3-L/P00	8052693	8052694	8052695	
		4	60V	4A	PUR	BK	•	AL-WKP4-L/S370	8052672	8045620	8052673	
				4A	PUR	BK	•	AL-WKP4-L/S400	8075187	8075188	8075420	
				4A	PUR	GY	•	AL-WKP4-L/S370GY	8068015	8068022	8068023	
				4A	PUR	OG	•	AL-WKP4-L/S7400	8067716	8067745	8067746	
				4A	PVC	BK	•	AL-WKP4-L/P01BK	8082034	8082035	8082036	
				4A	PVC	GY	•	AL-WKP4-L/P01	8052720	8052721	8052722	
				4A	PVC	GY		AL-WKP4-L/P00	8052696	8052697	8052698	
5	30V	3A	PUR	BK	•	AL-WKP4.5-L/S370	8050022	8050023	8050024			
		3A	PUR	BK	•	AL-WKP4.5-L/S400	8075207	8075208	8075426			
		3A	PVC	GY		AL-WKP4.5-L/P00	8049767	8050007	8050008			
	Anschlussleitung Kupplung, Ø8mm snap, gewinkelt, mit Zugsicherung	3	60V	4A	PUR	BK	•	AL-ZWKP3-L/S370	8052683	8052684	8052685	
				4A	PUR	BK	•	AL-ZWKP3-L/S400	8075178	8075179	8075417	
				4A	PUR	GY	•	AL-ZWKP3-L/S370GY	8059146	8059147	8059148	
				4A	PUR	OG	•	AL-ZWKP3-L/S7400	8059149	8059150	8059151	
				4A	PVC	BK	•	AL-ZWKP3-L/P01BK	8082053	8082054	8082055	
				4A	PVC	GY	•	AL-ZWKP3-L/P01	8052739	8052740	8052741	
				4A	PVC	GY		AL-ZWKP3-L/P00	8052711	8052712	8052713	
		4	60V	4A	PUR	BK	•	AL-ZWKP4-L/S370	8046075	8052686	8052687	
				4A	PUR	BK	•	AL-ZWKP4-L/S400	8075198	8075199	8075423	
				4A	PUR	GY	•	AL-ZWKP4-L/S370GY	8068035	8068036	8068037	
				4A	PUR	OG	•	AL-ZWKP4-L/S7400	8067751	8067752	8067753	
				4A	PVC	BK	•	AL-ZWKP4-L/P01BK	8082056	8082057	8082058	
				4A	PVC	GY	•	AL-ZWKP4-L/P01	8052742	8052743	8052744	
				4A	PVC	GY		AL-ZWKP4-L/P00	8052714	8052715	8052716	
5	30V	3A	PUR	BK	•	AL-ZWKP4.5-L/S370	8050028	8050029	8050030			
		3A	PUR	BK	•	AL-ZWKP4.5-L/S400	8075226	8075227	8075429			
		3A	PVC	GY		AL-ZWKP4.5-L/P00	8049769	8050011	8050012			

* Unsere Standardleitungslängen sind 2m, 5m oder 10m für Anschlussleitungen und 1m, 2m oder 5m für Verbindungsleitungen. Die Litzenlänge bei Flanschen beträgt 0,5m (POWER 0,2m). Alle anderen Leitungs- und Litzenlängen liefern wir Ihnen gern auf Anfrage.

		Kopf				Leitung			Artikelbezeichnung	L = Leitungslänge*		
		Pol	U[max]	I[max]	LED	Material	Farbe	UL		2m / 1m	5m / 2m	10m / 5m
	Anschlussleitung Stecker, Ø8mm snap, axial	3	60V	4A	PUR	BK	•	AL-SP3-L/S370	8051905	8051906	8051907	
				4A	PUR	BK	•	AL-SP3-L/S400	8075166	8075167	8075411	
				4A	PUR	GY	•	AL-SP3-L/S370GY	8059164	8059165	8059166	
				4A	PUR	OG	•	AL-SP3-L/S7400	8059167	8059168	8059169	
				4A	PVC	BK	•	AL-SP3-L/P01BK	8082016	8082017	8082018	
				4A	PVC	GY	•	AL-SP3-L/P01	8052499	8052500	8052501	
				4A	PVC	GY		AL-SP3-L/P00	8052496	8052497	8052498	
		4	60V	4A	PUR	BK	•	AL-SP4-L/S370	8052674	8052675	8052676	
				4A	PUR	BK	•	AL-SP4-L/S400	8075184	8075185	8075419	
				4A	PUR	GY	•	AL-SP4-L/S370GY	8067972	8067973	8067978	
				4A	PUR	OG	•	AL-SP4-L/S7400	8067705	8067706	8067707	
				4A	PVC	BK	•	AL-SP4-L/P01BK	8082040	8082041	8082042	
				4A	PVC	GY	•	AL-SP4-L/P01	8052727	8052728	8052729	
				4A	PVC	GY		AL-SP4-L/P00	8052699	8052700	8052701	
5	30V	3A	PUR	BK	•	AL-SP4.5-L/S370	8050013	8050014	8050015			
		3A	PUR	BK	•	AL-SP4.5-L/S400	8075204	8075205	8075425			
		3A	PVC	GY		AL-SP4.5-L/P00	8050000	8050001	8050002			
	Anschlussleitung Stecker, Ø8mm snap, gewinkelt	3	60V	4A	PUR	BK	•	AL-WSP3-L/S370	8051908	8051909	8051910	
				4A	PUR	BK	•	AL-WSP3-L/S400	8075172	8075173	8075414	
				4A	PUR	GY	•	AL-WSP3-L/S370GY	8059170	8059171	8059172	
				4A	PUR	OG	•	AL-WSP3-L/S7400	8059173	8059174	8059175	
				4A	PVC	BK	•	AL-WSP3-L/P01BK	8082019	8082020	8082021	
				4A	PVC	GY	•	AL-WSP3-L/P01	8052505	8052506	8052507	
				4A	PVC	GY		AL-WSP3-L/P00	8052502	8052503	8052504	
		4	60V	4A	PUR	BK	•	AL-WSP4-L/S370	8052677	8052678	8052679	
				4A	PUR	BK	•	AL-WSP4-L/S400	8075190	8075191	8075421	
				4A	PUR	GY	•	AL-WSP4-L/S370GY	8068011	8068012	8068014	
				4A	PUR	OG	•	AL-WSP4-L/S7400	8067711	8067712	8067713	
				4A	PVC	BK	•	AL-WSP4-L/P01BK	8082043	8082044	8082045	
				4A	PVC	GY	•	AL-WSP4-L/P01	8052730	8052731	8052732	
				4A	PVC	GY		AL-WSP4-L/P00	8052702	8052703	8052704	
5	30V	3A	PUR	BK	•	AL-WSP4.5-L/S370	8050019	8050020	8050021			
		3A	PUR	BK	•	AL-WSP4.5-L/S400	8075212	8075213	8075427			
		3A	PVC	GY		AL-WSP4.5-L/P00	8043900	8050003	8050004			

* Unsere Standardleitungslängen sind 2m, 5m oder 10m für Anschlussleitungen und 1m, 2m oder 5m für Verbindungsleitungen. Die Litzenlänge bei Flanschen beträgt 0,5m (POWER 0,2m). Alle anderen Leitungs- und Litzenlängen liefern wir Ihnen gern auf Anfrage.

		Kopf				Leitung			Artikelbezeichnung	L = Leitungslänge*		
		Pol	U[max]	I[max]	LED	Material	Farbe	UL		2m / 1m	5m / 2m	10m / 5m
	Verbindungsleitung Kupplung, Ø8mm snap, axial Stecker, Ø 8mm snap, axial	3	60V	4A	PUR	BK	•	AL-KP3-L-AL-SP3/S370	8073042	8073043	8071534	
				4A	PUR	GY	•	AL-KP3-L-AL-SP3/S370GY	8075777	8075778	8075779	
				4A	PUR	OG	•	AL-KP3-L-AL-SP3/S7400	8070025	8075725	8062204	
				4A	PVC	GY		AL-KP3-L-AL-SP3/P00	8061414	8057497	8075724	
		4	60V	4A	PUR	BK	•	AL-KP4-L-AL-SP4/S370	8059299	8053638	8044452	
				4A	PUR	GY	•	AL-KP4-L-AL-SP4/S370GY	8075793	8075794	8075795	
				4A	PUR	OG	•	AL-KP4-L-AL-SP4/S7400	8075790	8075791	8075792	
				4A	PVC	GY		AL-KP4-L-AL-SP4/P00	8075728	8075729	8068882	
5	30V	3A	PUR	BK	•	AL-KP4.5-L-AL-SP4.5/S370	8052970	8052971	8052972			
		3A	PVC	GY		AL-KP4.5-L-AL-SP4.5/P00	8052958	8052959	8052960			
	Verbindungsleitung Kupplung, Ø8mm snap, gewinkelt Stecker, Ø 8mm snap, axial	3	60V	4A	PUR	BK	•	AL-WKP3-L-AL-SP3/S370	8063830	8056384	8075727	
				4A	PUR	GY	•	AL-WKP3-L-AL-SP3/S370GY	8075787	8075788	8075789	
				4A	PUR	OG	•	AL-WKP3-L-AL-SP3/S7400	8075784	8075785	8075786	
				4A	PVC	GY		AL-WKP3-L-AL-SP3/P00	8075781	8075782	8075783	
		4	60V	4A	PUR	BK	•	AL-WKP4-L-AL-SP4/S370	8076453	8076454	8076455	
				4A	PUR	GY	•	AL-WKP4-L-AL-SP4/S370GY	8075802	8075803	8075804	
				4A	PUR	OG	•	AL-WKP4-L-AL-SP4/S7400	8075799	8075800	8075801	
				4A	PVC	GY		AL-WKP4-L-AL-SP4/P00	8075796	8075797	8075798	
		5	30V	3A	PUR	BK	•	AL-WKP4.5-L-AL-SP4.5/S370	8052979	8052980	8052981	
				3A	PVC	GY		AL-WKP4.5-L-AL-SP4.5/P00	8052967	8052968	8052969	

* Unsere Standardleitungslängen sind 2m, 5m oder 10m für Anschlussleitungen und 1m, 2m oder 5m für Verbindungsleitungen. Die Litzenlänge bei Flanschen beträgt 0,5m (POWER 0,2m). Alle anderen Leitungs- und Litzenlängen liefern wir Ihnen gern auf Anfrage.

Nomenklatur Steckverbinder konfektioniert

Verbindungsleitung

FB-	S	W	WAK	H	3-	P2-	L	- FB -	S	W	WAS	H	3	/S3930
														Leitungsqualität
														Polzahl
														Hygienic Design
														WAS: M12x1 Stecker SP: M8x1 Stecker
														W: gewinkelt ohne: axial
														M8x1 schraubbar
														Food & Beverage
														Leitungslänge [m]
														PNP Anzahl der LEDs + Beschaltung
														Polzahl
														Hygienic Design
														WAK: M12x1 Kupplung WAS: M12x1 Stecker KP: M8x1 Kupplung SP: M8x1 Stecker
														W: gewinkelt ohne: axial
														M8x1 schraubbar
														Food & Beverage

Food & Beverage



*nicht P00 und P01

Leitung	Kurzbeschreibung
P00 PVC	Flexible PVC/PVC Sensor-/Aktorsteuerleitung für mittlere mechanische Beanspruchungen. Bedingt öl- und chemikalienbeständig.
P01 PVC	Flexible PVC/PVC Sensor-/Aktorsteuerleitung für mittlere mechanische Beanspruchungen. Bedingt öl- und chemikalienbeständig, mit UL-Style.
S3930 TPE	Flexible TPE/TPE Sensor-/Aktorsteuerleitung für Anwendungen im Lebensmittelbereich. Gute Mikroben- und Chemikalienbeständigkeit, FDA zugelassene Materialien.











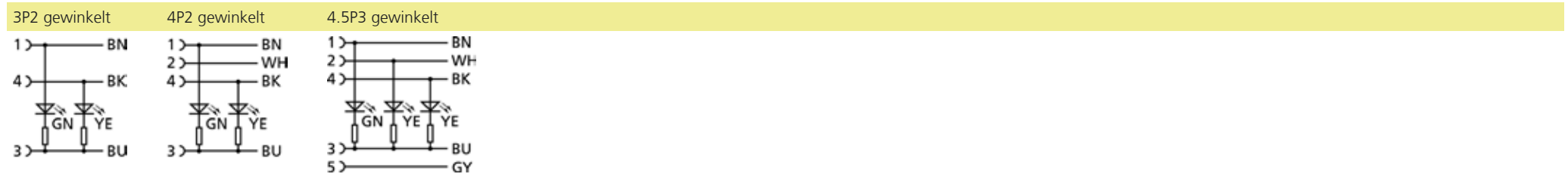



Abbildung im Maßstab ~ 1:1









Food & Beverage





Technische Daten	M12x1	M8x1	Flansche	Selbstkonfektionierbar
Isolationswiderstand	$\geq 10^8 \Omega$	$\geq 10^8 \Omega$	$\geq 10^8 \Omega$	$\geq 10^8 \Omega$
Durchgangswiderstand	$\leq 5 m\Omega$	$\leq 5 m\Omega$	$\leq 5 m\Omega$	$\leq 5 m\Omega$
Umgebungstemperatur	-40°C...+105°C	-40°C...+105°C	-40°C...+105°C	-40°C...+85°C
Material Kontakte	Metall, vergoldet	Metall, vergoldet	Metall, vergoldet	Metall, vergoldet
Material Kontaktträger	Kunststoff, PP	Kunststoff, PP	Kunststoff, PP	Kunststoff, PA
Material Griffkörper	Kunststoff, PP	Kunststoff, PP		Zinkdruckguss, vernickelt
Material Überwurf	Edelstahl, V4A	Edelstahl, V4A	Edelstahl, V4A	Edelstahl, V4A
Material Dichtung (Kupplung)	EPDM	EPDM	FPM/FKM	
Material äußere Dichtung			EPDM	
Material Flanschgehäuse			V4A	
Normen	IEC 61076-2-101	IEC 61076-2-104	IEC 61076-2-101	IEC 61076-2-101
Schutzart (montiert)	IP65, IP67, IP68, IP69	IP65, IP67, IP68, IP69	IP65, IP67, IP68, IP69	IP67
Mechanische Lebensdauer	>100 Steckzyklen	>100 Steckzyklen	>100 Steckzyklen	>100 Steckzyklen
Verschmutzungsgrad	3	3/2	3	3
Kabeldurchlass				4...6 mm
Anschlussquerschnitt				max. 0,75 mm ²

Unsere Food & Beverage-Steckverbinder im ‚Hygienic Design‘ wurden in Anlehnung an EHEDG-Richtlinien entwickelt. Die Verwendung von FDA-konformen Materialien gewährleistet eine hohe Resistenz gegenüber sauren und alkalischen Desinfektions- und Reinigungsmitteln. Alle M8x1- und M12x1-Komponenten sind staub- und wasserdicht sowie resistent gegen Hochdruck- und Dampfstrahlreinigung (IP65, IP67, IP68 und IP69). Mit PVC und TPE bieten wir die passenden Leitungsqualitäten für Ihre Applikation.

		Kopf				Leitung			Artikelbezeichnung	L = Leitungslänge*		
		Pol	U[max]	I[max]	LED	Material	Farbe	UL		2m / 1m	5m / 2m	10m / 5m
	Anschlussleitung Kupplung, M12x1, axial	3	250V	4A		PVC	GY		FB-WAKH3-L/P00	8063805	8063806	8063807
				4A		PVC	GY		FB-WAKH3-L/P01	8063748	8063749	8063752
				4A		TPE	GY		FB-WAKH3-L/S3930	8050462	8058555	8058556
		4	250V	4A		PVC	GY		FB-WAKH4-L/P00	8063811	8063812	8063813
				4A		PVC	GY		FB-WAKH4-L/P01	8063724	8063725	8063728
				4A		TPE	GY		FB-WAKH4-L/S3930	8050464	8058557	8058558
		5	60V	4A		PVC	GY		FB-WAKH4.5-L/P00	8063817	8063818	8063819
				4A		PVC	GY		FB-WAKH4.5-L/P01	8063739	8063740	8063741
				4A		TPE	GY		FB-WAKH4.5-L/S3930	8063882	8063883	8063884
	Anschlussleitung Kupplung, M12x1, gewinkelt	3	250V	4A		PVC	GY		FB-WWAKH3-L/P00	8063834	8063835	8063836
				4A		PVC	GY		FB-WWAKH3-L/P01	8063703	8063704	8063705
				4A		TPE	GY		FB-WWAKH3-L/S3930	8050463	8058559	8058560
		4	250V	4A		PVC	GY		FB-WWAKH4-L/P00	8063799	8063800	8063801
				4A		PVC	GY		FB-WWAKH4-L/P01	8063672	8063673	8063674
				4A		TPE	GY		FB-WWAKH4-L/S3930	8050465	8058561	8058562
		5	60V	4A		PVC	GY		FB-WWAKH4.5-L/P00	8063823	8063824	8063825
				4A		PVC	GY		FB-WWAKH4.5-L/P01	8063687	8063688	8063689
				4A		TPE	GY		FB-WWAKH4.5-L/S3930	8063885	8063886	8063887
	Anschlussleitung Kupplung, M12x1, gewinkelt, mit LED	3	30V	3A	3P2	PVC	GY		FB-WWAKH3P2-L/P00	8063826	8063827	8063828
				3A	3P2	PVC	GY		FB-WWAKH3P2-L/P01	8063692	8063693	8063694
				3A	3P2	TPE	GY		FB-WWAKH3P2-L/S3930	8058611	8058612	8058613
		4	30V	3A	4P2	PVC	GY		FB-WWAKH4P2-L/P00	8063787	8063788	8063789
				3A	4P2	PVC	GY		FB-WWAKH4P2-L/P01	8063666	8063667	8063668
				3A	4P2	TPE	GY		FB-WWAKH4P2-L/S3930	8058614	8058615	8058616
		5	30V	3A	5P3	PVC	GY		FB-WWAKH4.5P3-L/P00	8063808	8063809	8063810
				3A	5P3	PVC	GY		FB-WWAKH4.5P3-L/P01	8063678	8063679	8063680
				3A	5P3	TPE	GY		FB-WWAKH4.5P3-L/S3930	8063802	8063803	8063804
	Anschlussleitung Stecker, M12x1, axial	3	250V	4A		PVC	GY		FB-WASH3-L/P00	8063843	8063844	8063845
				4A		PVC	GY		FB-WASH3-L/P01	8063715	8063716	8063717
				4A		TPE	GY		FB-WASH3-L/S3930	8050468	8058563	8058564
		4	250V	4A		PVC	GY		FB-WASH4-L/P00	8063837	8063838	8063839
				4A		PVC	GY		FB-WASH4-L/P01	8063706	8063707	8063708
				4A		TPE	GY		FB-WASH4-L/S3930	8050470	8058565	8058566
		5	60V	4A		PVC	GY		FB-WASH4.5-L/P00	8063840	8063841	8063842
				4A		PVC	GY		FB-WASH4.5-L/P01	8063709	8063710	8063711
				4A		TPE	GY		FB-WASH4.5-L/S3930	8063888	8063889	8063890

		Kopf				Leitung			Artikelbezeichnung	L = Leitungslänge*		
		Pol	U[max]	I[max]	LED	Material	Farbe	UL		2m / 1m	5m / 2m	10m / 5m
	Anschlussleitung Stecker, M12x1, gewinkelt	3	250V	4A		PVC	GY		FB-WWASH3-L/P00	8063781	8063782	8063783
				4A		PVC	GY		FB-WWASH3-L/P01	8063663	8063664	8063665
				4A		TPE	GY		FB-WWASH3-L/S3930	8050469	8058567	8058568
		4	250V	4A		PVC	GY		FB-WWASH4-L/P00	8063775	8063776	8063777
				4A		PVC	GY		FB-WWASH4-L/P01	8063655	8063656	8063657
				4A		TPE	GY		FB-WWASH4-L/S3930	8050471	8058569	8058570
		5	60V	4A		PVC	GY		FB-WWASH4.5-L/P00	8063675	8063676	8063677
				4A		PVC	GY		FB-WWASH4.5-L/P01	8063660	8063661	8063662
				4A		TPE	GY		FB-WWASH4.5-L/S3930	8063891	8063892	8063893
	Verbindungsleitung Kupplung, M12x1, axial Stecker, M12x1, axial	3	250V	4A		PVC	GY		FB-WAKH3-L-FB-WASH3/P00	8063852	8063853	8063854
				4A		PVC	GY		FB-WAKH3-L-FB-WASH3/P01	8063742	8063744	8063747
				4A		TPE	GY		FB-WAKH3-L-FB-WASH3/S3930	8058587	8058588	8058589
		4	250V	4A		PVC	GY		FB-WAKH4-L-FB-WASH4/P00	8063846	8063847	8063848
				4A		PVC	GY		FB-WAKH4-L-FB-WASH4/P01	8063721	8063722	8063723
				4A		TPE	GY		FB-WAKH4-L-FB-WASH4/S3930	8058590	8058591	8058592
		5	60V	4A		PVC	GY		FB-WAKH4.5-L-FB-WASH4.5/P00	8063849	8063850	8063851
				4A		PVC	GY		FB-WAKH4.5-L-FB-WASH4.5/P01	8063733	8063734	8063735
				4A		TPE	GY		FB-WAKH4.5-L-FB-WASH4.5/S3930	8063681	8063682	8063683
	Verbindungsleitung Kupplung, M12x1, gewinkelt Stecker, M12x1, gewinkelt	3	250V	4A		PVC	GY		FB-WWAKH3-L-FB-WWASH3/P00	8063831	8063832	8063833
				4A		PVC	GY		FB-WWAKH3-L-FB-WWASH3/P01	8063697	8063698	8063699
				4A		TPE	GY		FB-WWAKH3-L-FB-WWASH3/S3930	8058593	8058594	8058595
		4	250V	4A		PVC	GY		FB-WWAKH4-L-FB-WWASH4/P00	8063793	8063794	8063795
				4A		PVC	GY		FB-WWAKH4-L-FB-WWASH4/P01	8063669	8063670	8063671
				4A		TPE	GY		FB-WWAKH4-L-FB-WWASH4/S3930	8058596	8058597	8058598
		5	60V	4A		PVC	GY		FB-WWAKH4.5-L-FB-WWASH4.5/P00	8063820	8063821	8063822
				4A		PVC	GY		FB-WWAKH4.5-L-FB-WWASH4.5/P01	8063684	8063685	8063686
				4A		TPE	GY		FB-WWAKH4.5-L-FB-WWASH4.5/S3930	8063814	8063815	8063816
	Flansch Kupplung, M12x1, axial Lötanschluss Vorderwandmontage	4	250V	4A					FB-FKE4-L/PG9	8068276		
		5	60V	4A					FB-FKE4.5-L/PG9	8068277		
	Flansch Kupplung, M12x1, axial Litzenanschluss Vorderwandmontage	4	250V	4A					FB-FKE4-0,5/PG9	8068278		
		5	60V	4A					FB-FKE4.5-0,5/PG9	8068279		
	Flansch Stecker, M12x1, axial Lötanschluss Vorderwandmontage	4	250V	4A					FB-FSE4-L/PG9	8068272		
		5	60V	4A					FB-FSE4.5-L/PG9	8068273		

		Kopf				Leitung			Artikelbezeichnung	L = Leitungslänge*		
		Pol	U[max]	I[max]	LED	Material	Farbe	UL		2m / 1m	5m / 2m	10m / 5m
	Flansch Stecker, M12x1, axial Litzenanschluss Vorderwandmontage	4	250V	4A					FB-FSE4-0,5/PG9	8068274		
		5	60V	4A					FB-FSE4.5-0,5/PG9	8068275		
	Steckverbinder selbstkonfektionierbar Kupplung, M12x1, axial Schraub-/Klemmanschluss	5	125V	4A					WAKCE5K	8063393		
	Steckverbinder selbstkonfektionierbar Kupplung, M12x1, gewinkelt Schraub-/Klemmanschluss	5	125V	4A					WWAKCE5K	8063395		
	Steckverbinder selbstkonfektionierbar Stecker, M12x1, axial Schraub-/Klemmanschluss	5	125V	4A					WASCE5K	8063394		
	Steckverbinder selbstkonfektionierbar Stecker, M12x1, gewinkelt Schraub-/Klemmanschluss	5	125V	4A					WWASCE5K	8063396		
	Anschlussleitung Kupplung, M8x1, axial	3	60V	4A		PVC	GY		FB-SKPH3-L/P00	8063690	8063653	8063691
				4A		PVC	GY		FB-SKPH3-L/P01	8063700	8063701	8063702
				4A		TPE	GY		FB-SKPH3-L/S3930	8050454	8058571	8058572
		4	60V	4A		PVC	GY		FB-SKPH4-L/P00	8063652	8063695	8063696
				4A		PVC	GY		FB-SKPH4-L/P01	8063712	8063713	8063714
				4A		TPE	GY		FB-SKPH4-L/S3930	8050455	8058573	8058574
	Anschlussleitung Kupplung, M8x1, gewinkelt	3	60V	4A		PVC	GY		FB-SWKPH3-L/P00	8063718	8063719	8063720
				4A		PVC	GY		FB-SWKPH3-L/P01	8063730	8063731	8063732
				4A		TPE	GY		FB-SWKPH3-L/S3930	8050456	8058575	8058576
		4	60V	4A		PVC	GY		FB-SWKPH4-L/P00	8063726	8063727	8063729
				4A		PVC	GY		FB-SWKPH4-L/P01	8063736	8063737	8063738
				4A		TPE	GY		FB-SWKPH4-L/S3930	8050457	8058577	8058578
	Anschlussleitung Kupplung, M8x1, gewinkelt, mit LED	3	30V	3A	3P2	PVC	GY		FB-SWKPH3P2-L/P00	8063743	8063745	8063746
				3A	3P2	PVC	GY		FB-SWKPH3P2-L/P01	8063761	8063763	8063765
				3A	3P2	TPE	GY		FB-SWKPH3P2-L/S3930	8058619	8058620	8058621
		4	30V	3A	4P2	PVC	GY		FB-SWKPH4P2-L/P00	8063750	8063751	8063753
				3A	4P2	PVC	GY		FB-SWKPH4P2-L/P01	8063760	8063762	8063764
				3A	4P2	TPE	GY		FB-SWKPH4P2-L/S3930	8058622	8058623	8058624

		Kopf				Leitung			Artikelbezeichnung	L = Leitungslänge*		
		Pol	U[max]	I[max]	LED	Material	Farbe	UL		2m / 1m	5m / 2m	10m / 5m
	Anschlussleitung Stecker, M8x1, axial	3	60V	4A	PVC	GY		FB-SSPH3-L/P00	8063769	8063770	8063771	
				4A	PVC	GY		FB-SSPH3-L/P01	8063778	8063779	8063780	
				4A	TPE	GY		FB-SSPH3-L/S3930	8050458	8058579	8058580	
		4	60V	4A	PVC	GY		FB-SSPH4-L/P00	8063772	8063773	8063774	
				4A	PVC	GY		FB-SSPH4-L/P01	8063784	8063785	8063786	
				4A	TPE	GY		FB-SSPH4-L/S3930	8050459	8058581	8058582	
	Anschlussleitung Stecker, M8x1, gewinkelt	3	60V	4A	PVC	GY		FB-SWSPH3-L/P00	8063790	8063791	8063792	
				4A	PVC	GY		FB-SWSPH3-L/P01	8063757	8063758	8063759	
				4A	TPE	GY		FB-SWSPH3-L/S3930	8050460	8058583	8058584	
		4	60V	4A	PVC	GY		FB-SWSPH4-L/P00	8063796	8063797	8063798	
				4A	PVC	GY		FB-SWSPH4-L/P01	8063754	8063755	8063756	
				4A	TPE	GY		FB-SWSPH4-L/S3930	8050461	8058585	8058586	
	Verbindungsleitung Kupplung, M8x1, axial Stecker, M8x1, axial	3	60V	4A	PVC	GY		FB-SKPH3-L-FB-SSPH3/P00	8063875	8063876	8063877	
				4A	PVC	GY		FB-SKPH3-L-FB-SSPH3/P01	8063864	8063865	8063866	
				4A	TPE	GY		FB-SKPH3-L-FB-SSPH3/S3930	8058599	8058600	8058601	
		4	60V	4A	PVC	GY		FB-SKPH4-L-FB-SSPH4/P00	8063861	8063862	8063863	
				4A	PVC	GY		FB-SKPH4-L-FB-SSPH4/P01	8063867	8063868	8063869	
				4A	TPE	GY		FB-SKPH4-L-FB-SSPH4/S3930	8058602	8058603	8058604	
	Verbindungsleitung Kupplung, M8x1, gewinkelt Stecker, M8x1, gewinkelt	3	60V	4A	PVC	GY		FB-SWKPH3-L-FB-SWSPH3/P00	8063858	8063859	8063860	
				4A	PVC	GY		FB-SWKPH3-L-FB-SWSPH3/P01	8063871	8063872	8063873	
				4A	TPE	GY		FB-SWKPH3-L-FB-SWSPH3/S3930	8058605	8058606	8058607	
		4	60V	4A	PVC	GY		FB-SWKPH4-L-FB-SWSPH4/P00	8063855	8063856	8063857	
				4A	PVC	GY		FB-SWKPH4-L-FB-SWSPH4/P01	8063766	8063767	8063768	
				4A	TPE	GY		FB-SWKPH4-L-FB-SWSPH4/S3930	8058608	8058609	8058610	

* Unsere Standardleitungslängen sind 2m, 5m oder 10m für Anschlussleitungen und 1m, 2m oder 5m für Verbindungsleitungen. Die Litzenlänge bei Flanschen beträgt 0,5m (POWER 0,2m). Alle anderen Leitungs- und Litzenlängen liefern wir Ihnen gern auf Anfrage.

Nomenklatur Steckverbinder konfektioniert

Verbindungsleitung

HT-	S	W	WAK	3-	L	- HT-	S	W	WAS	3	/S2430
											Leitungsqualität
											Polzahl
											WAS: M12x1 Stecker SP: M8x1 Stecker
											W: gewinkelt ohne: axial
											M8x1 schraubbar
											Hochtemperaturfest
											Leitungslänge [m]
											Polzahl
											WAK: M12x1 Kupplung WAS: M12x1 Stecker KP: M8x1 Kupplung SP: M8x1 Stecker
											W: gewinkelt ohne: axial
											M8x1 schraubbar
											Hochtemperaturfest

Hochtemperaturfest



Leitung	Kurzbeschreibung
S2430, PTFE	Flexible PTFE/PTFE Sensor-/Aktorsignalleitung für Anwendungen mit extremen Temperaturen. Gute Öl- und Chemikalienbeständigkeit, flammwidrig.



Abbildung im Maßstab ~ 1:1





Hochtemperaturfest

Technische Daten	M12x1	M8x1	Flansche
Isolationswiderstand	≥10 ⁸ Ω	≥10 ⁸ Ω	≥10 ⁸ Ω
Durchgangswiderstand	≤ 5mΩ	≤ 5mΩ	≤ 5mΩ
Umgebungstemperatur	-20°C...+150°C	-20°C...+150°C	-20°C...+150°C
Material Kontakte	Metall, vergoldet	Metall, vergoldet	Metall, vergoldet
Material Kontaktträger	Kunststoff, PBT GF	Kunststoff, PBT GF	Kunststoff, PBT GF
Material Griffkörper	Kunststoff, PBT GF	Kunststoff, PBT GF	
Material Überwurf	Metall, CuZn, vernickelt	Metall, CuZn, vernickelt	
Material Dichtung (Kupplung)	FPM/FKM	FPM/FKM	FPM/FKM
Material äußere Dichtung			FPM/FKM
Material Flanschgehäuse			Metall, CuZn, vernickelt
Normen	IEC 61076-2-101	IEC 61076-2-104	IEC 61076-2-101
Schutzart (montiert)	IP65	IP65	IP65, IP67, IP68
Mechanische Lebensdauer	>100 Steckzyklen	>100 Steckzyklen	>100 Steckzyklen
Verschmutzungsgrad	3	3	3

Selbst bei außergewöhnlich hohen Temperaturbelastungen gewährleisten hochtemperaturfeste Materialien eine zuverlässige Funktionsweise unserer M8x1- und M12x1-Steckverbinder. Dauergebrauchstemperaturen von -20°C bis +150°C und eine kurzfristige Spitzenbelastung bis +200°C sind für diese Produktfamilie kein Problem.

		Kopf				Leitung			Artikelbezeichnung	L = Leitungslänge*		
		Pol	U[max]	I[max]	Extra	Material	Farbe	UL		2m / 1m	5m / 2m	10m / 5m
	Anschlussleitung Kupplung, M12x1, axial	3	250V	4A		PTFE	WH		HT-WAK3-L/S2430	8039210	8036085	8039211
		4	250V	4A		PTFE	WH		HT-WAK4-L/S2430	8036518	8036086	8036154
		5	60V	4A		PTFE	WH		HT-WAK4.5-L/S2430	8039212	8036087	8039213
	Anschlussleitung Kupplung, M12x1, gewinkelt	3	250V	4A		PTFE	WH		HT-WWAK3-L/S2430	8039224	8036088	8039225
		4	250V	4A		PTFE	WH		HT-WWAK4-L/S2430	8039226	8036089	8037214
		5	60V	4A		PTFE	WH		HT-WWAK4.5-L/S2430	8039227	8036090	8039228
	Anschlussleitung Stecker, M12x1, axial	3	250V	4A		PTFE	WH		HT-WAS3-L/S2430	8039231	8036091	8039232
		4	250V	4A		PTFE	WH		HT-WAS4-L/S2430	8039233	8036092	8039234
		5	60V	4A		PTFE	WH		HT-WAS4.5-L/S2430	8039235	8036093	8038342
	Anschlussleitung Stecker, M12x1, gewinkelt	3	250V	4A		PTFE	WH		HT-WWAS3-L/S2430	8039467	8036094	8039468
		4	250V	4A		PTFE	WH		HT-WWAS4-L/S2430	8039469	8036095	8039470
		5	60V	4A		PTFE	WH		HT-WWAS4.5-L/S2430	8039471	8036096	8039472
	Verbindungsleitung Kupplung, M12x1, axial Stecker, M12x1, axial	3	250V	4A		PTFE	WH		HT-WAK3-L-HT-WAS3/S2430	8036254	8039479	8039480
		4	250V	4A		PTFE	WH		HT-WAK4-L-HT-WAS4/S2430	8038667	8038668	8038669
		5	60V	4A		PTFE	WH		HT-WAK4.5-L-HT-WAS4.5/S2430	8051958	8039949	8039950
	Verbindungsleitung Kupplung, M12x1, gewinkelt Stecker, M12x1, gewinkelt	3	250V	4A		PTFE	WH		HT-WWAK3-L-HT-WWAS3/S2430	8051956	8039958	8039959
		4	250V	4A		PTFE	WH		HT-WWAK4-L-HT-WWAS4/S2430	8051957	8039961	8039137
		5	60V	4A		PTFE	WH		HT-WWAK4.5-L-HT-WWAS4.5/S2430	8051959	8039963	8039964
	Flansch Kupplung, M12x1, axial Litzenanschluss Vorderwandmontage	3	250V	4A					HT-FK3-0,5/16/S2470	8037311		
		4	250V	4A					HT-FK4-0,5/16/S2470	8037322		
		5	60V	4A					HT-FK4.5-0,5/16/S2470	8037323		
	Flansch Stecker, M12x1, axial Litzenanschluss Vorderwandmontage	3	250V	4A					HT-FS3-0,5/16/S2470	8037288		
		4	250V	4A					HT-FS4-0,5/16/S2470	8037292		
		5	60V	4A					HT-FS4.5-0,5/16/S2470	8037293		
	Anschlussleitung Kupplung, M8x1, axial	3	60V	4A		PTFE	WH		HT-SKP3-L/S2430	8036605	8036097	8039482
		4	60V	4A		PTFE	WH		HT-SKP4-L/S2430	8039483	8036098	8037215
	Anschlussleitung Kupplung, M8x1, gewinkelt	3	60V	4A		PTFE	WH		HT-SWKP3-L/S2430	8039484	8036099	8039485
		4	60V	4A		PTFE	WH		HT-SWKP4-L/S2430	8039486	8036100	8037216
	Anschlussleitung Stecker, M8x1, axial	3	60V	4A		PTFE	WH		HT-SSP3-L/S2430	8039487	8036101	8039488
		4	60V	4A		PTFE	WH		HT-SSP4-L/S2430	8039489	8036102	8039490

* Unsere Standardleitungslängen sind 2m, 5m oder 10m für Anschlussleitungen und 1m, 2m oder 5m für Verbindungsleitungen. Die Litzenlänge bei Flanschen beträgt 0,5m (POWER 0,2m). Alle anderen Leitungs- und Litzenlängen liefern wir Ihnen gern auf Anfrage.

		Kopf				Leitung			Artikelbezeichnung	L = Leitungslänge*		
		Pol	U[max]	I[max]	Extra	Material	Farbe	UL		2m / 1m	5m / 2m	10m / 5m
	Anschlussleitung Stecker, M8x1, gewinkelt	3	60V	4A		PTFE	WH		HT-SWSP3-L/S2430	8039491	8036103	8039492
		4	60V	4A		PTFE	WH		HT-SWSP4-L/S2430	8039493	8036104	8039494
	Verbindungsleitung Kupplung, M8x1, axial	3	60V	4A		PTFE	WH		HT-SKP3-L-HT-SSP3/S2430	8043355	8039972	8039973
		4	60V	4A		PTFE	WH		HT-SKP4-L-HT-SSP4/S2430	8051990	8039975	8039976
	Verbindungsleitung Kupplung, M8x1, gewinkelt	3	60V	4A		PTFE	WH		HT-SWKP3-L-HT-SWSP3/S2430	8051991	8039978	8039979
		4	60V	4A		PTFE	WH		HT-SWKP4-L-HT-SWSP4/S2430	8051992	8039981	8039982
	Verbindungsleitung Stecker, M8x1, gewinkelt											

Hochtemperaturfest

* Unsere Standardleitungslängen sind 2m, 5m oder 10m für Anschlussleitungen und 1m, 2m oder 5m für Verbindungsleitungen. Die Litzenlänge bei Flanschen beträgt 0,5m (POWER 0,2m). Alle anderen Leitungs- und Litzenlängen liefern wir Ihnen gern auf Anfrage.

Nomenklatur

AL-	FV	M12	S	S	A	3.xxx	P/	M16	S520
									positionierbar
									Befestigungsgewinde M16x1,5
									P: Printkontakt L: Lötkontakt 0,5: Litzenlänge [m]
									Kontakte.Anschlussbelegung
									Codierung
									S: geschirmt U: ohne
									S: Stecker K: Kupplung
									M12: M12x1 M8: M8x1
									FV: Flansch Vorderwandmontage FH: Flansch Hinterwandmontage
									Produktfamilie

Durch die Weiterentwicklung unseres plattformorientierten Einbausteckverbinder- und Flanschprogramms haben wir die Nomenklatur umgestellt. Für Ihren Service bilden wir neben der bisherigen und weiterhin gültigen Nomenklatur (unten) auch die neue Nomenklatur (oben) ab.

Einbausteckverbinder | Flansche









IE-	W	FK	F	D	E	S	X	8-	F	L	/ 16	/ S3500	/ S3525
													Extra: z.B Wanddickenausgleich oder farbiger Kontaktträger
													Leitungsqualität
													Befestigungsgewinde 16: M16x1,5 12: M12x1
													Leitungs-/Litzenlänge [m]
													F: M8x1 frontseitig verschraubbar (Hinterwandmontage)
													Polzahl
													Codierung
													geschirmt
													E: Edelstahl 1.4404 ohne: CuZn, vernickelt
													drehbare Befestigungsschraube
													F: M12x1 frontseitig verschraubbar (Hinterwandmontage) S: M8x1: schraubbar
													FK: Kupplung FS: Stecker
													W: gewinkelt ohne: axial
													Produktfamilie















Abbildung im Maßstab ~ 1:1











Einbausteckverbinder | Flansche











Technische Daten	Flansch M12x1	Flansch M8x1	Einbaustecker M12x1	Einbaustecker M8x1	Einbaustecker Ø8mm snap
Isolationswiderstand	$\geq 10^8 \Omega$	$\geq 10^8 \Omega$	$\geq 10^8 \Omega$	$\geq 10^8 \Omega$	$\geq 10^8 \Omega$
Durchgangswiderstand	$\leq 5 m\Omega$	$\leq 5 m\Omega$	$\leq 5 m\Omega$	$\leq 5 m\Omega$	$\leq 5 m\Omega$
Umgebungstemperatur	-30°C...+90°C (*+70°C)	-30°C...+90°C	-30°C...+90°C	-30°C...+90°C	-30°C...+90°C
Material Kontakte	Metall, vergoldet	Metall, vergoldet	Metall, vergoldet	Metall, vergoldet	Metall, vergoldet
Material Kontakträger	Kunststoff	Kunststoff	Kunststoff	Kunststoff	Kunststoff, PA
Material Dichtung (Kupplung)	FPM/FKM/EPDM (FB)	FPM/FKM			
Material äußere Dichtung	NBR/EPDM (FB)	NBR			
Material Flanschgehäuse	Metall Edelstahl	Metall Edelstahl			
Normen	IEC 61076-2-101	IEC 61076-2-104	IEC 61076-2-101	IEC 61076-2-104	IEC 61076-2-104
Schutzart (montiert)	IP65, IP67, IP68	IP65, IP67, IP68	IP65, IP67	IP65, IP67	IP65, IP67
Mechanische Lebensdauer	>100 Steckzyklen	>100 Steckzyklen	>100 Steckzyklen	>100 Steckzyklen	>100 Steckzyklen
Verschmutzungsgrad	3	3/2	3/2	3/2	3/2











		Anschlussart	Befestigungsgewinde	Pole	Cod.	U[max]	I[max]	Δh[mm]	UL	L [m]	Artikelbezeichnung	Art.-Nr.
	Flansch Kupplung, M12x1, axial Sensor/Aktor Vorderwandmontage	Lötanschluss	M16x1,5	3	A	250V	4A		•		EC-FK3-L/16	8027566
				4	A	250V	4A		•		EC-FK4-L/16	8027569
				4+PE	A	60V	4A		•		EC-FK5-L/16	8027570
				5	A	60V	4A		•		EC-FK4.5-L/16	8052079
				8	A	30V	2A		•		EC-FK8-L/16	8028122
				12	A	30V	1,5A				EC-FK12-L/16	8028124
	Flansch Kupplung, M12x1, axial Sensor/Aktor Vorderwandmontage	Litzenanschluss	M16x1,5	3	A	250V	4A			0,5	AL-FVM12KUA3-0,5/M16	8071679
				4	A	250V	4A			0,5	AL-FVM12KUA4-0,5/M16	8071682
				4+PE	A	60V	4A			0,5	AL-FVM12KUA5-0,5/M16	8071693
				5	A	60V	4A			0,5	AL-FVM12KUA4.5-0,5/M16	8071691
				8	A	30V	2A			0,5	AL-FVM12KUA8-0,5/M16	8071695
				12	A	30V	1,5A			0,5	AL-FVM12KUA12-0,5/M16	8071696
	Flansch Kupplung, M12x1, axial Sensor/Aktor Vorderwandmontage Edelstahl	Lötanschluss	M16x1,5	3	A	250V	4A		•		EC-FKE3-L/16	8029169
				4	A	250V	4A		•		EC-FKE4-L/16	8029170
				4+PE	A	60V	4A		•		EC-FKE5-L/16	8029171
				8	A	30V	2A		•		EC-FKE8-L/16	8029016
				12	A	30V	1,5A				EC-FKE12-L/16	8029701
	Flansch Kupplung, M12x1, axial Sensor/Aktor Vorderwandmontage Edelstahl	Litzenanschluss	M16x1,5	3	A	250V	4A		•	0,5	EC-FKE3-0,5/16	8028126
				4	A	250V	4A		•	0,5	EC-FKE4-0,5/16	8028127
				4+PE	A	60V	4A		•	0,5	EC-FKE5-0,5/16	8028131
				5	A	60V	4A		•	0,5	EC-FKE4.5-0,5/16	8028128
				8	A	30V	2A		•	0,5	EC-FKE8-0,5/16	8029015
				12	A	30V	1,5A			0,5	EC-FKE12-0,5/16	8029696
	Flansch Kupplung, M12x1, axial Sensor/Aktor Vorderwandmontage, positionierbar	Litzenanschluss	M16x1,5	3	A	250V	4A			0,5	AL-FVM12KUA3-0,5/M16/S520	8077913
				4	A	250V	4A			0,5	AL-FVM12KUA4-0,5/M16/S520	8077902
				4+PE	A	60V	4A			0,5	AL-FVM12KUA5-0,5/M16/S520	8077908
				5	A	60V	4A			0,5	AL-FVM12KUA4.5-0,5/M16/S520	8077906
				8	A	30V	2A			0,5	AL-FVM12KUA8-0,5/M16/S520	8077911
				12	A	30V	1,5A			0,5	AL-FVM12KUA12-0,5/M16/S520	8077912
	Flansch Stecker, M12x1, axial Sensor/Aktor Vorderwandmontage	Lötanschluss	M16x1,5	3	A	250V	4A		•		EC-FS3-L/16	8029545
				4	A	250V	4A		•		EC-FS4-L/16	8029546
				4+PE	A	60V	4A		•		EC-FS5-L/16	8029548
				5	A	60V	4A		•		EC-FS4.5-L/16	8029547
				8	A	30V	2A		•		EC-FS8-L/16	8029551
				12	A	30V	1,5A				EC-FS12-L/16	8029552













		Anschlussart	Befestigungsgewinde	Pole	Cod.	U[max]	I[max]	Δh[mm]	UL	L [m]	Artikelbezeichnung	Art.-Nr.
	Flansch Stecker, M12x1, axial Sensor/Aktor Vorderwandmontage	Litzenanschluss	M16x1,5	3	A	250V	4A			0,5	AL-FVM12SUA3-0,5/M16	8071801
				4	A	250V	4A			0,5	AL-FVM12SUA4-0,5/M16	8071802
				4+PE	A	60V	4A			0,5	AL-FVM12SUA5-0,5/M16	8071808
				5	A	60V	4A			0,5	AL-FVM12SUA4.5-0,5/M16	8071805
				8	A	30V	2A			0,5	AL-FVM12SUA8-0,5/M16	8071810
				12	A	30V	1,5A			0,5	AL-FVM12SUA12-0,5/M16	8071811
	Flansch Stecker, M12x1, axial Sensor/Aktor Vorderwandmontage Edelstahl	Lötanschluss	M16x1,5	3	A	250V	4A		•		EC-FSE3-L/16	8029553
				4	A	250V	4A		•		EC-FSE4-L/16	8029554
				4+PE	A	60V	4A		•		EC-FSE5-L/16	8029556
				5	A	60V	4A		•		EC-FSE4.5-L/16	8029555
				8	A	30V	2A		•		EC-FSE8-L/16	8029557
				12	A	30V	1,5A				EC-FSE12-L/16	8029558
	Flansch Stecker, M12x1, axial Sensor/Aktor Vorderwandmontage Edelstahl	Litzenanschluss	M16x1,5	3	A	250V	4A		•	0,5	EC-FSE3-0,5/16	8028145
				4	A	250V	4A		•	0,5	EC-FSE4-0,5/16	8028147
				4+PE	A	60V	4A		•	0,5	EC-FSE5-0,5/16	8028149
				5	A	60V	4A		•	0,5	EC-FSE4.5-0,5/16	8028148
				8	A	30V	2A		•	0,5	EC-FSE8-0,5/16	8029083
				12	A	30V	1,5A			0,5	EC-FSE12-0,5/16	8029344
	Flansch Stecker, M12x1, axial Sensor/Aktor Vorderwandmontage, positionierbar	Litzenanschluss	M16x1,5	3	A	250V	4A			0,5	AL-FVM12SUA3-0,5/M16/S520	8077964
				4	A	250V	4A			0,5	AL-FVM12SUA4-0,5/M16/S520	8077965
				4+PE	A	60V	4A			0,5	AL-FVM12SUA5-0,5/M16/S520	8077972
				5	A	60V	4A			0,5	AL-FVM12SUA4.5-0,5/M16/S520	8077969
				8	A	30V	2A			0,5	AL-FVM12SUA8-0,5/M16/S520	8077974
				12	A	30V	1,5A			0,5	AL-FVM12SUA12-0,5/M16/S520	8077975
	Flansch Kupplung, M12x1, axial Sensor/Aktor Hinterwandmontage	Printanschluss	M16x1,5	3	A	250V	4A				AL-FHM12KUA3-P/M16	8072160
				4	A	250V	4A				AL-FHM12KUA4-P/M16	8072162
				4+PE	A	60V	4A				AL-FHM12KUA5-P/M16	8072168
				8	A	30V	2A				AL-FHM12KUA8-P/M16	8072170
				12	A	30V	1,5A				AL-FHM12KUA12-P/M16	8072171
	Flansch Kupplung, M12x1, axial Sensor/Aktor Hinterwandmontage	Litzenanschluss	M16x1,5	3	A	250V	4A			0,5	AL-FHM12KUA3-0,5/M16	8071533
				4	A	250V	4A			0,5	AL-FHM12KUA4-0,5/M16	8071536
				4+PE	A	60V	4A			0,5	AL-FHM12KUA5-0,5/M16	8071666
				5	A	60V	4A			0,5	AL-FHM12KUA4.5-0,5/M16	8071540
				8	A	30V	2A			0,5	AL-FHM12KUA8-0,5/M16	8071668
				12	A	30V	1,5A			0,5	AL-FHM12KUA12-0,5/M16	8071669











		Anschlussart	Befestigungsgewinde	Pole	Cod.	U[max]	I[max]	Δh[mm]	UL	L [m]	Artikelbezeichnung	Art.-Nr.
	Flansch Kupplung, M12x1, axial Sensor/Aktor Hinterwandmontage drehbare Befestigungsschraube Edelstahl	Printanschluss	M16x1,5	3	A	250V	4A		•		EC-FKFDE3-P/16	8029695
				4	A	250V	4A		•		EC-FKFDE4-P/16	8029508
				4+PE	A	60V	4A		•		EC-FKFDE5-P/16	8029509
				8	A	30V	2A		•		EC-FKFDE8-P/16	8029510
				12	A	30V	1,5A				EC-FKFDE12-P/16	8029512
	Flansch Kupplung, M12x1, axial Sensor/Aktor Hinterwandmontage drehbare Befestigungsschraube Edelstahl	Litzenanschluss	M16x1,5	3	A	250V	4A		•	0,5	EC-FKFDE3-0,5/16	8029175
				4	A	250V	4A		•	0,5	EC-FKFDE4-0,5/16	8029176
				4+PE	A	60V	4A		•	0,5	EC-FKFDE5-0,5/16	8029189
				5	A	60V	4A		•	0,5	EC-FKFDE4.5-0,5/16	8029752
				8	A	30V	2A		•	0,5	EC-FKFDE8-0,5/16	8029160
				12	A	30V	1,5A		0,5	EC-FKFDE12-0,5/16	8029700	
	Flansch Kupplung, M12x1, gewinkelt Hinterwandmontage	Printanschluss		4	A	250V	4A	1,0...2,5	•		EC-WFKF4-P/12/S3525	8050275
				4	A	250V	4A	2,5...4,0	•		EC-WFKF4-P/12/S3540	8050274
				4	A	250V	4A	4,0...5,0	•		EC-WFKF4-P/12/S3550	8045188
				4+PE	A	60V	4A	1,0...2,5	•		EC-WFKF5-P/12/S3525	8050273
				4+PE	A	60V	4A	2,5...4,0	•		EC-WFKF5-P/12/S3540	8050272
				4+PE	A	60V	4A	4,0...5,0	•		EC-WFKF5-P/12/S3550	8050257
	Flansch Stecker, M12x1, axial Sensor/Aktor Hinterwandmontage	Printanschluss	M16x1,5	3	A	250V	4A				AL-FHM12SUA3-P/M16	8072348
				4	A	250V	4A				AL-FHM12SUA4-P/M16	8072349
				4+PE	A	60V	4A				AL-FHM12SUA5-P/M16	8072354
				5	A	60V	4A				AL-FHM12SUA4.5-P/M16	8072352
				8	A	30V	2A				AL-FHM12SUA8-P/M16	8072356
				12	A	30V	1,5A			AL-FHM12SUA12-P/M16	8072357	
	Flansch Stecker, M12x1, axial Sensor/Aktor Hinterwandmontage	Litzenanschluss	M16x1,5	3	A	250V	4A			0,5	AL-FHM12SUA3-0,5/M16	8071790
				4	A	250V	4A			0,5	AL-FHM12SUA4-0,5/M16	8071791
				4+PE	A	60V	4A			0,5	AL-FHM12SUA5-0,5/M16	8071796
				5	A	60V	4A			0,5	AL-FHM12SUA4.5-0,5/M16	8071794
				8	A	30V	2A			0,5	AL-FHM12SUA8-0,5/M16	8071799
				12	A	30V	1,5A		0,5	AL-FHM12SUA12-0,5/M16	8071800	
	Flansch Stecker, M12x1, axial Sensor/Aktor Hinterwandmontage drehbare Befestigungsschraube Edelstahl	Printanschluss	M16x1,5	3	A	250V	4A		•		EC-FSFDE3-P/16	8029496
				4	A	250V	4A		•		EC-FSFDE4-P/16	8029498
				4+PE	A	60V	4A		•		EC-FSFDE5-P/16	8029502
				8	A	30V	2A		•		EC-FSFDE8-P/16	8029504
				12	A	30V	1,5A				EC-FSFDE12-P/16	8029506













		Anschlussart	Befestigungsgewinde	Pole	Cod.	U[max]	I[max]	Δh[mm]	UL	L [m]	Artikelbezeichnung	Art.-Nr.	
	Flansch Stecker, M12x1, axial Sensor/Aktor Hinterwandmontage drehbare Befestigungsschraube Edelstahl	Litzenanschluss	M16x1,5	3	A	250V	4A		•	0,5	EC-FSFDE3-0,5/16	8029213	
				4	A	250V	4A		•	0,5	EC-FSFDE4-0,5/16	8029214	
				4+PE	A	60V	4A		•	0,5	EC-FSFDE5-0,5/16	8029216	
				5	A	60V	4A		•	0,5	EC-FSFDE4.5-0,5/16	8029215	
				8	A	30V	2A		•	0,5	EC-FSFDE8-0,5/16	8029158	
				12	A	30V	1,5A			0,5	EC-FSFDE12-0,5/16	8029212	
	Flansch Stecker, M12x1, gewinkelt Sensor/Aktor Hinterwandmontage	Printanschluss		4	A	250V	4A	1,0...5,0	•		EC-WFSF4-P/12	8046571	
				4+PE	A	60V	4A		•		EC-WFSF5-P/12	8044960	
	Einbaustecker Stecker, M12x1	Lötanschluss		4	A	250V	4A				EWAS4	8008155	
				4+PE	A	60V	4A					EWAS5	8017592
				5	A	60V	4A					EWAS4.5	8008156
				8	A	30V	2A					EWAS8	8009737
				12	A	30V	1,5A					EWAS12	8030496
	Flansch Kupplung, M12x1, axial Food & Beverage Vorderwandmontage	Lötanschluss	PG9	4	A	250V	4A				FB-FKE4-L/PG9	8068276	
				5	A	60V	4A					FB-FKE4.5-L/PG9	8068277
	Flansch Kupplung, M12x1, axial Food & Beverage Vorderwandmontage	Litzenanschluss	PG9	4	A	250V	4A			0,5	FB-FKE4-0,5/PG9	8068278	
				5	A	60V	4A			0,5	FB-FKE4.5-0,5/PG9	8068279	
	Flansch Stecker, M12x1, axial Food & Beverage Vorderwandmontage	Lötanschluss	PG9	4	A	250V	4A				FB-FSE4-L/PG9	8068272	
				5	A	60V	4A					FB-FSE4.5-L/PG9	8068273
	Flansch Stecker, M12x1, axial Food & Beverage Vorderwandmontage	Litzenanschluss	PG9	4	A	250V	4A			0,5	FB-FSE4-0,5/PG9	8068274	
				5	A	60V	4A			0,5	FB-FSE4.5-0,5/PG9	8068275	
	Flansch Kupplung, M12x1, axial Hochtemperatur Vorderwandmontage	Litzenanschluss	M16x1,5	3	A	250V	4A			0,5	HT-FK3-0,5/16/S2470	8037311	
				4	A	250V	4A			0,5	HT-FK4-0,5/16/S2470	8037322	
				5	A	60V	4A			0,5	HT-FK4.5-0,5/16/S2470	8037323	
	Flansch Stecker, M12x1, axial Hochtemperatur Vorderwandmontage	Litzenanschluss	M16x1,5	3	A	250V	4A			0,5	HT-FS3-0,5/16/S2470	8037288	
				4	A	250V	4A			0,5	HT-FS4-0,5/16/S2470	8037292	
				5	A	60V	4A			0,5	HT-FS4.5-0,5/16/S2470	8037293	
	Flansch Kupplung, M12x1, axial Industrial Ethernet, rail approved Hinterwandmontage	Litzenanschluss	M16x1,5	4	D	250V	4A			0,5	IE-FHM12KUD4.029-0,5/M16	8072504	

		Anschlussart	Befestigungsgewinde	Pole	Cod.	U[max]	I[max]	Δh[mm]	UL	L [m]	Artikelbezeichnung	Art.-Nr.
	Flansch Stecker, M12x1, axial Industrial Ethernet, rail approved Hinterwandmontage	Litzenanschluss	M16x1,5	4	D	250V	4A			0,5	IE-FHM12SUD4.029-0,5/M16	8072520
	Flansch Kupplung, M12x1, axial Industrial Ethernet, rail approved Vorderwandmontage	Litzenanschluss	M16x1,5	4	D	250V	4A			0,5	IE-FVM12KUD4.029-0,5/M16	8072505
	Flansch Kupplung, M12x1, axial Industrial Ethernet, rail approved Vorderwandmontage, positionierbar	Litzenanschluss	M16x1,5	4	D	250V	4A			0,5	IE-FVM12KUD4.029-0,5/M16/S520	8077905
	Flansch Stecker, M12x1, axial Industrial Ethernet, rail approved Vorderwandmontage	Litzenanschluss	M16x1,5	4	D	250V	4A			0,5	IE-FVM12SUD4.029-0,5/M16	8072521
	Flansch Stecker, M12x1, axial Industrial Ethernet, rail approved Vorderwandmontage, positionierbar	Litzenanschluss	M16x1,5	4	D	250V	4A			0,5	IE-FVM12SUD4.029-0,5/M16/S520	8077968
	Flansch Stecker, M12x1, axial Industrial Ethernet, rail approved Hinterwandmontage	Printanschluss	M16x1,5	4	D	250V	4A	1,0...5,0			IE-FHM12SUD4-P/M16	8072586
	Flansch Kupplung, M12x1, axial geschirmt Industrial Ethernet Vorderwandmontage modular drehbare Befestigungsschraube	Printanschluss	M12x1	8	X	50V _{AC} 60V _{DC}	0,5A	0,9...2,5			IE-FKDHSX8-P/12	8053483
	Flansch Kupplung, M12x1, axial geschirmt Industrial Ethernet, rail approved Vorderwandmontage drehbare Befestigungsschraube	Printanschluss	M12x1	8	X	50V _{AC} 60V _{DC}	0,5A	0,9...2,5			IE-FKDSX8-P/12	8050232
	Flansch Kupplung, M12x1, axial Industrial Ethernet, rail approved Hinterwandmontage	Printanschluss	M16x1,5	4	D	250V	4A	1,0...5,0			IE-FHM12KUD4-P/M16	8072576
	Flansch Kupplung, M12x1, axial geschirmt Industrial Ethernet, rail approved Hinterwandmontage modular drehbare Befestigungsschraube	Printanschluss		8	X	50V _{AC} 60V _{DC}	0,5A	0,9...2,5			IE-FKFDHSX8-P	8053485
	Flansch Kupplung, M12x1, axial Industrial Ethernet, rail approved Hinterwandmontage	Printanschluss	M12x1	4	D	250V	4A	1,0...2,5			IE-FHM12KUD4-P/M12/S3525	8074847
				4	D	250V	4A	2,5...4,0			IE-FHM12KUD4-P/M12/S3540	8074846
				4	D	250V	4A	4,0...5,0			IE-FHM12KUD4-P/M12/S3550	8072578

		Anschlussart	Befestigungsgewinde	Pole	Cod.	U[max]	I[max]	Δh[mm]	UL	L [m]	Artikelbezeichnung	Art.-Nr.
	Flansch Kupplung, M12x1, gewinkelt geschirmt Industrial Ethernet Hinterwandmontage	Printanschluss	M12x1	4	D	250V	4A	1,0...2,5			IE-WFKFSY4-P/12/S3525	8050282
				4	D	250V	4A	2,5...4,0			IE-WFKFSY4-P/12/S3540	8050284
				4	D	250V	4A	4,0...5,0			IE-WFKFSY4-P/12/S3550	8050285
	Flansch Kupplung, M12x1, gewinkelt geschirmt Hinterwandmontage	Printanschluss		8	X	50V _{AC} 60V _{DC}	0,5A	1,0...2,5			IE-WFKFSX8-P/12/S3525	8059345
				8	X	50V _{AC} 60V _{DC}	0,5A	2,5...4,0			IE-WFKFSX8-P/12/S3540	8059346
				8	X	50V _{AC} 60V _{DC}	0,5A	4,0...5,0			IE-WFKFSX8-P/12/S3550	8059347
	Flansch Anschlussleitung Kupplung, M12x1, axial Industrial Ethernet Hinterwandmontage drehbare Befestigungsschraube	Leitung	M16x1,5	4	D	250V	4A			2	IE-FKFDSY4.029-2/16/S2171	8063608
				4	D	250V	4A			5	IE-FKFDSY4.029-5/16/S2171	8063609
				4	D	250V	4A			10	IE-FKFDSY4.029-10/16/S2171	8063610
	Flansch Anschlussleitung Kupplung, M12x1, axial Industrial Ethernet Hinterwandmontage drehbare Befestigungsschraube	Leitung	M16x1,5	4	D	250V	4A			2	IE-FKFDSY4.082-2/16/S3400	8064034
				4	D	250V	4A			5	IE-FKFDSY4.082-5/16/S3400	8064035
				4	D	250V	4A			10	IE-FKFDSY4.082-10/16/S3400	8064036
	Flansch Anschlussleitung Kupplung, M12x1, gewinkelt Industrial Ethernet Hinterwandmontage drehbare Befestigungsschraube	Leitung	M16x1,5	4	D	250V	4A			2	IE-WFKFDSY4.029-2/16/S2171	8063611
				4	D	250V	4A			5	IE-WFKFDSY4.029-5/16/S2171	8063612
				4	D	250V	4A			10	IE-WFKFDSY4.029-10/16/S2171	8063613
	Flansch Anschlussleitung Kupplung, M12x1, axial Industrial Ethernet Vorderwandmontage	Leitung	M16x1,5	4	D	250V	4A			2	IE-FKSY4.029-2/16/S3800/S3801	8063605
				4	D	250V	4A			5	IE-FKSY4.029-5/16/S3800/S3801	8063606
				4	D	250V	4A			10	IE-FKSY4.029-10/16/S3800/S3801	8063607
	Flansch Kupplung, M12x1, axial Industrial Ethernet Hinterwandmontage drehbare Befestigungsschraube	Printanschluss	M16x1,5	4	D	250V	4A		•		IE-FKFDY4-P/16/S38	8055849
	Flansch Kupplung, M12x1, gewinkelt Industrial Ethernet Hinterwandmontage	Printanschluss		4	D	250V	4A	1,0...2,5			IE-WFKFSY4-P/12/S3825	8055850
				4	D	250V	4A	2,5...4,0			IE-WFKFSY4-P/12/S3840	8055851
				4	D	250V	4A	4,0...5,0			IE-WFKFSY4-P/12/S3850	8055852
	Flansch Anschlussleitung Kupplung, M12x1, axial Industrial Ethernet Hinterwandmontage drehbare Befestigungsschraube	Leitung	M16x1,5	4	D	250V	4A			2	IE-FKFDSY4.029-2/16/S3800/S38	8063599
				4	D	250V	4A			5	IE-FKFDSY4.029-5/16/S3800/S38	8063600
				4	D	250V	4A			10	IE-FKFDSY4.029-10/16/S3800/S38	8063601
	Flansch Anschlussleitung Kupplung, M12x1, gewinkelt Industrial Ethernet Hinterwandmontage drehbare Befestigungsschraube	Leitung	M16x1,5	4	D	250V	4A			2	IE-WFKFDSY4.029-2/16/S3800/S38	8063602
				4	D	250V	4A			5	IE-WFKFDSY4.029-5/16/S3800/S38	8063603
				4	D	250V	4A			10	IE-WFKFDSY4.029-10/16/S3800/S38	8063604

		Anschlussart	Befestigungsgewinde	Pole	Cod.	U[max]	I[max]	Δh[mm]	UL	L [m]	Artikelbezeichnung	Art.-Nr.
	Flansch Anschlussleitung Kupplung, M12x1, axial Profibus Vorderwandmontage	Leitung	M16x1,5	5	B	60V	4A		•	2	PB-FKSW2.012-2/16/S1800/S3941	8063621
				5	B	60V	4A		•	5	PB-FKSW2.012-5/16/S1800/S3941	8063622
				5	B	60V	4A		•	10	PB-FKSW2.012-10/16/S1800/S3941	8063623
	Flansch Kupplung, M12x1, gewinkelt Profibus Hinterwandmontage	Printanschluss	M12x1	5	B	60V	4A	1,0...2,5			PB-WFKFSW5-P/12/S3525	8050279
				5	B	60V	4A	2,5...4,0			PB-WFKFSW5-P/12/S3540	8050280
				5	B	60V	4A	4,0...5,0			PB-WFKFSW5-P/12/S3550	8050281
	Flansch Kupplung, M12x1, axial Profibus Hinterwandmontage	Litzenanschluss	M16x1,5	5	B	60V	4A			0,5	PB-FHM12KUB2.012-0,5/M16	8072599
											PB-FHM12KUB5-P/M16	8072611
	Flansch Kupplung, M12x1, axial Profibus Hinterwandmontage	Printanschluss	M16x1,5	5	B	60V	4A				PB-FHM12SUB2.012-0,5/M16	8072633
	Flansch Stecker, M12x1, axial Profibus Hinterwandmontage	Litzenanschluss	M16x1,5	5	B	60V	4A			0,5	PB-FHM12SUB2.012-0,5/M16	8072633
											PB-FHM12SUB5-P/M16	8072640
	Flansch Stecker, M12x1, axial Profibus Hinterwandmontage	Printanschluss	M16x1,5	5	B	60V	4A				PB-FHM12SUB2.012-0,5/M16	8072633
	Flansch Kupplung, M12x1, axial Profibus Vorderwandmontage	Litzenanschluss	M16x1,5	5	B	60V	4A			0,5	PB-FVM12KUB2.012-0,5/M16	8072602
											PB-FVM12KUB2.012-0,5/M16/S520	8077910
	Flansch Kupplung, M12x1, axial Profibus Vorderwandmontage, positionierbar	Litzenanschluss	M16x1,5	5	B	60V	4A			0,5	PB-FVM12KUB2.012-0,5/M16/S520	8077910
											PB-FVM12SUB2.012-0,5/M16	8072634
	Flansch Stecker, M12x1, axial Profibus Vorderwandmontage	Litzenanschluss	M16x1,5	5	B	60V	4A			0,5	PB-FVM12SUB2.012-0,5/M16	8072634
											PB-FVM12SUB2.012-0,5/M16/S520	8077971
	Flansch Stecker, M12x1, axial Profibus Vorderwandmontage, positionierbar	Litzenanschluss	M16x1,5	5	B	60V	4A			0,5	PB-FVM12SUB2.012-0,5/M16/S520	8077971
											PB-FVM12SUB2.012-0,5/M16/S520	8077971
	Flansch Stecker, M12x1, gewinkelt Profibus Hinterwandmontage	Printanschluss	M12x1	5	B	60V	4A				PB-WFFSW5-P/12	8045658
	Flansch Anschlussleitung Kupplung, M12x1, axial Profibus Hinterwandmontage drehbare Befestigungsschraube	Leitung	M16x1,5	5	B	60V	4A		•	2	PB-FKFDSW2.012-2/16/S1800	8061882
				5	B	60V	4A		•	5	PB-FKFDSW2.012-5/16/S1800	8063617
				5	B	60V	4A		•	10	PB-FKFDSW2.012-10/16/S1800	8063618

		Anschlussart	Befestigungsgewinde	Pole	Cod.	U[max]	I[max]	Δh[mm]	UL	L [m]	Artikelbezeichnung	Art.-Nr.
	Flansch Anschlussleitung Kupplung, M12x1, gewinkelt Profibus Hinterwandmontage drehbare Befestigungsschraube	Leitung	M16x1,5	5	B	60V	4A		•	2	PB-WFKFDSW2.012-2/16/S1800	8061881
				5	B	60V	4A		•	5	PB-WFKFDSW2.012-5/16/S1800	8063619
				5	B	60V	4A		•	10	PB-WFKFDSW2.012-10/16/S1800	8063620
	Flansch Kupplung, M12x1, axial CAN open/DeviceNet Vorderwandmontage	Litzenanschluss	M16x1,5	5	A	60V	4A			0,5	CD-FK5.022-0,5/16	8047958
	Flansch Stecker, M12x1, axial CAN open/DeviceNet Vorderwandmontage	Litzenanschluss	M16x1,5	5	A	60V	4A			0,5	CD-F55.022-0,5/16	8047960
	Flansch Kupplung, M12x1, axial CAN open/DeviceNet Hinterwandmontage drehbare Befestigungsschraube	Litzenanschluss	M16x1,5	5	A	60V	4A			0,5	CD-FKFD5.022-0,5/16	8047961
	Flansch Stecker, M12x1, axial CAN open/DeviceNet Hinterwandmontage drehbare Befestigungsschraube	Litzenanschluss	M16x1,5	5	A	60V	4A			0,5	CD-F5FD5.022-0,5/16	8047962
	Flansch Kupplung, M12x1, axial POWER Vorderwandmontage	Litzenanschluss	M16x1,5	2+PE	S	630V	16A			0,2	PS-FVM12K3.031-0,2	8064859
				3+PE	S	630V	12A			0,2	PS-FVM12K4.165-0,2	8067075
	Flansch Stecker, M12x1, axial POWER Vorderwandmontage	Litzenanschluss	M16x1,5	2+PE	S	630V	16A			0,2	PS-FVM12S3.031-0,2	8064858
				3+PE	S	630V	12A			0,2	PS-FVM12S4.165-0,2	8067074
	Flansch Kupplung, M12x1, axial POWER Hinterwandmontage	Litzenanschluss	M16x1,5	2+PE	S	630V	16A			0,2	PS-FHM12K3.031-0,2	8064861
				3+PE	S	630V	12A			0,2	PS-FHM12K4.165-0,2	8067077
	Flansch Stecker, M12x1, axial POWER Hinterwandmontage	Litzenanschluss	M16x1,5	2+PE	S	630V	16A			0,2	PS-FHM12S3.031-0,2	8064860
				3+PE	S	630V	12A			0,2	PS-FHM12S4.165-0,2	8067076
	Flansch Kupplung, M12x1, axial POWER Vorderwandmontage	Litzenanschluss	M16x1,5	4	T	63V	12A			0,2	PT-FVM12K4-0,2	8064855
	Flansch Stecker, M12x1, axial POWER Vorderwandmontage	Litzenanschluss	M16x1,5	4	T	63V	12A			0,2	PT-FVM12S4-0,2	8064854

		Anschlussart	Befestigungsgewinde	Pole	Cod.	U[max]	I[max]	Δh[mm]	UL	L [m]	Artikelbezeichnung	Art.-Nr.
	Flansch Kupplung, M12x1, axial POWER Hinterwandmontage	Litzenanschluss	M16x1,5	4	T	63V	12A			0,2	PT-FHM12K4-0,2	8064857
	Flansch Stecker, M12x1, axial POWER Hinterwandmontage	Litzenanschluss	M16x1,5	4	T	63V	12A			0,2	PT-FHM12S4-0,2	8064856
	Flansch Kupplung, M8x1, axial Sensor/Aktor Vorderwandmontage	Litzenanschluss	M8x0,5	3	A	60V	4A	2,0...5,0		0,2	AL-FVM8KUA3-0,2/M8	8071345
				4	A	60V	4A	2,0...5,0		0,2	AL-FVM8KUA4-0,2/M8	8071346
				5	B	30V	3A	2,0...5,0		0,2	AL-FVM8KUB4.5-0,2/M8	8071347
	Flansch Stecker, M8x1, axial Sensor/Aktor Vorderwandmontage	Litzenanschluss	M8x0,5	3	A	60V	4A	2,0...5,0		0,2	AL-FVM8SUA3-0,2/M8	8071417
				4	A	60V	4A	2,0...5,0		0,2	AL-FVM8SUA4-0,2/M8	8071419
				5	B	30V	3A	2,0...5,0		0,2	AL-FVM8SUB4.5-0,2/M8	8071420
	Flansch Kupplung, M8x1, axial Sensor/Aktor Hinterwandmontage	Litzenanschluss	M10x1	3	A	60V	4A	3,0...6,0		0,2	AL-FHM8KUA3-0,2/M10	8071402
				4	A	60V	4A	3,0...6,0		0,2	AL-FHM8KUA4-0,2/M10	8071405
				5	B	30V	3A	3,0...6,0		0,2	AL-FHM8KUB4.5-0,2/M10	8071406
	Flansch Kupplung, M8x1, axial Sensor/Aktor Hinterwandmontage drehbare Befestigungsschraube	Printanschluss	M10x1	3	A	60V	4A	3,0...6,0			AL-FHM8KUA3-P/M10	8073385
				4	A	60V	4A	3,0...6,0			AL-FHM8KUA4-P/M10	8073386
				5	B	30V	3A	3,0...6,0			AL-FHM8KUB4.5-P/M10	8073387
	Flansch Stecker, M8x1, axial Sensor/Aktor Hinterwandmontage	Litzenanschluss	M8x1	3	A	60V	4A	2,0...4,5		0,2	AL-FHM8SUA3-0,2/M8	8071421
				4	A	60V	4A	2,0...4,5		0,2	AL-FHM8SUA4-0,2/M8	8071422
				5	B	30V	3A	2,0...4,5		0,2	AL-FHM8SUB4.5-0,2/M8	8071423
	Flansch Stecker, M8x1, axial Sensor/Aktor Hinterwandmontage drehbare Befestigungsschraube	Printanschluss	M8x1	3	A	60V	4A	2,0...4,5			AL-FHM8SUA3-P/M8	8073397
				4	A	60V	4A	2,0...4,5			AL-FHM8SUA4-P/M8	8073398
				5	B	30V	3A	2,0...4,5			AL-FHM8SUB4.5-P/M8	8073399
	Einbaustecker Stecker, M8x1/Ø8mm snap	Lötanschluss		3		60V	4A				SESP3SL	8008157
				4		60V	4A				SESP4SL	8037479
	Flansch Kupplung, Ø8mm snap	Printanschluss		3		60V	4A				EKP3SP	8009728
				4		60V	4A				EKP4SP	8009729
				5		30V	3A				EKP4.5SP	8043797
	Einbaustecker Stecker, Ø8mm snap	Printanschluss		4		60V	4A				ESP4SP	8036657
				5		30V	3A				ESP5SP	8044285
	Einbaustecker Stecker, Ø8mm snap	Lötanschluss		3		60V	4A				ESP3SL	8008163
				4		60V	4A				ESP4SL	8008164
				5		30V	3A				ESP5SL	8044283

		Anschlussart	Befestigungsgewinde	Pole	Cod.	U[max]	I[max]	Δh [mm]	UL	L [m]	Artikelbezeichnung	Art.-Nr.
	Einbaustecker Stecker, Ø8mm snap	Printanschluss		3		60V	4A				ESHP3P	8008159
				4		60V	4A				ESHP4P	8008160
	Einbaustecker Stecker, Ø8mm snap	Lötanschluss		3		60V	4A				ESHP3L	8008161
				4		60V	4A				ESHP4L	8008162
	Einbaustecker Stecker, M8x1/Ø8mm snap	Printanschluss		3		60V	4A				ESGP3P	8008742
				4		60V	4A				ESGP4P	8008743
	Einbaustecker Stecker, M8x1/Ø8mm snap	Lötanschluss		3		60V	4A				ESGP3L	8008744
				4		60V	4A				ESGP4L	8008745

Nomenklatur

PB-	W	WAK	C	S	E	W	3-	K
-----	---	-----	---	---	---	---	----	---

Anschlussart K: Schraub-/Klemmanschluss | S: Schneid-/Klemmanschluss | L: Lötanschluss

Polzahl

Codierung

Edelstahlüberwurf

geschirmt

selbstkonfektionierbar

WAK: M12x1 Kupplung | WAS: M12x1 Stecker | KP: M8x1 Kupplung | SP: M8x1 Stecker | RJ45S: RJ45 Stecker

W: gewinkelt | ohne: axial

Produktfamilie PB: Profinet | IE: Industrial Ethernet | S: M8x1 schraubbar

Selbstkonfektionierbar







































Abbildung im Maßstab ~ 1:1





Selbstkonfektionierbare Steckverbinder

Technische Daten	M12x1	M12x1 geschirmt	M8x1	M23x1	RJ45
Isolationswiderstand	$\geq 10^8 \Omega$	$\geq 10^8 \Omega$	$\geq 10^8 \Omega$	$\geq 10^8 \Omega$	$\geq 10^8 \Omega$
Durchgangswiderstand	$\leq 5 m\Omega$	$\leq 5 m\Omega$	$\leq 5 m\Omega$	$\leq 5 m\Omega$	$\leq 5 m\Omega$
Umgebungstemperatur	-40°C...+85°C	-40°C...+85°C	-40°C...+85°C	-40°C...+125°C	-40°C...+70°C
Material Kontakte	Metall, vergoldet	Metall, vergoldet	Metall, vergoldet	Metall, vergoldet	Metall, vergoldet
Material Kontaktträger	Kunststoff, PA	Kunststoff, PA	Kunststoff, PA	Kunststoff, PBT	Kunststoff, PA
Material Griffkörper	Kunststoff	Zinkdruckguss, vernickelt	Kunststoff	Kunststoff	Kunststoff
Material Überwurf	Metall, vernickelt	Metall, vernickelt	Metall, vernickelt	Metall, vernickelt	
Normen	IEC 61076-2-101	IEC 61076-2-101	IEC 61076-2-104		IEC 60603-7-5
Schutzart (montiert)	IP67	IP67	IP67		IP20
Mechanische Lebensdauer	>100 Steckzyklen	>100 Steckzyklen	>100 Steckzyklen	>100 Steckzyklen	>750 Steckzyklen
Verschmutzungsgrad	3	3 (8X: 2)	3	3	1

		Kopf			Kabeldurchlass	Anschlussquerschnitt	Artikelbezeichnung	Artikel-Nr.
		Pol	U[max]	I[max]				
	Steckverbinder selbstkonfektionierbar Kupplung, M12x1, axial Schraub-/Klemmanschluss	4, A	250V	4A	4...6 mm	max. 0,75 mm ²	WAKC4K	8004811
		5, A	125V	4A	4...6 mm	max. 0,75 mm ²	WAKC5K	8004815
		8, A	60V	2A	6...8 mm	max. 0,5 mm ²	WAKC8K	8021862
	Steckverbinder selbstkonfektionierbar Kupplung, M12x1, axial Schraub-/Klemmanschluss Edelstahl	5, A	125V	4A	4...6 mm	max. 0,75 mm ²	WAKCE5K	8063393
	Steckverbinder selbstkonfektionierbar Kupplung, M12x1, gewinkelt Schraub-/Klemmanschluss	4, A	250V	4A	4...6 mm	max. 0,75 mm ²	WWAKC4K	8004808
		5, A	125V	4A	4...6 mm	max. 0,75 mm ²	WWAKC5K	8004809
		8, A	30V	2A	6...8 mm	max. 0,25 mm ²	WWAKC8K	8041146
	Steckverbinder selbstkonfektionierbar Kupplung, M12x1, gewinkelt Schraub-/Klemmanschluss Edelstahl	5, A	125V	4A	4...6 mm	max. 0,75 mm ²	WWAKCE5K	8063395
	Steckverbinder selbstkonfektionierbar Stecker, M12x1, axial Schraub-/Klemmanschluss	4, A	250V	4A	4...6 mm	max. 0,75 mm ²	WASC4K	8004804
		5, A	125V	4A	4...6 mm	max. 0,75 mm ²	WASC5K	8004805
		8, A	60V	2A	6...8 mm	max. 0,5 mm ²	WASC8K	8021863
	Steckverbinder selbstkonfektionierbar Stecker, M12x1, axial Schraub-/Klemmanschluss Edelstahl	5, A	125V	4A	4...6 mm	max. 0,75 mm ²	WASCE5K	8063394
	Steckverbinder selbstkonfektionierbar Stecker, M12x1, gewinkelt Schraub-/Klemmanschluss	4, A	250V	4A	4...6 mm	max. 0,75 mm ²	WWASC4K	8004806
		5, A	125V	4A	4...6 mm	max. 0,75 mm ²	WWASC5K	8004807
		8, A	30V	2A	6...8 mm	max. 0,75 mm ²	WWASC8K	8052219
	Steckverbinder selbstkonfektionierbar Stecker, M12x1, gewinkelt Schraub-/Klemmanschluss Edelstahl	5, A	125V	4A	4...6 mm	max. 0,75 mm ²	WWASCE5K	8063396
	Steckverbinder selbstkonfektionierbar Kupplung, M12x1, axial Schneid-/Klemmanschluss	3, A	32V	4A	2,9...5,1 mm	0,14...0,34 mm ² AWG26...22	WAKC3S	8019714
		4, A	32V	4A	2,9...5,1 mm	0,14...0,34 mm ² AWG26...22	WAKC4S	8019718
	Steckverbinder selbstkonfektionierbar Kupplung, M12x1, gewinkelt Schneid-/Klemmanschluss	4, A	32V	4A	4...5,1 mm	max. 0,5 mm ²	WWAKC4S	8019719
	Steckverbinder selbstkonfektionierbar Stecker, M12x1, axial Schneid-/Klemmanschluss	3, A	32V	4A	2,9...5,1 mm	0,14...0,34 mm ² AWG26...22	WASC3S	8019712
		4, A	32V	4A	2,9...5,1 mm	0,14...0,34 mm ² AWG26...22	WASC4S	8019716

		Kopf			Kabeldurchlass	Anschlussquerschnitt	Artikelbezeichnung	Artikel-Nr.
		Pol	U[max]	I[max]				
	Steckverbinder selbstkonfektionierbar Stecker, M12x1, gewinkelt Schneid-/Klemmanschluss	4, A	32V	4A	4...5,1mm	max. 0,5 mm ²	WWASC4S	8019717
	Steckverbinder selbstkonfektionierbar Kupplung, M12x1, axial Lötanschluss	12, A	30V	1A	6...8 mm	max. 0,25 mm ²	WAKC12L	8031858
	Steckverbinder selbstkonfektionierbar Kupplung, M12x1, gewinkelt Lötanschluss	12, A	30V	2A	6...8 mm	max. 0,25 mm ²	WWAKC12L	8031859
	Steckverbinder selbstkonfektionierbar Stecker, M12x1, axial Lötanschluss	12, A	30V	2A	6...8 mm	max. 0,25 mm ²	WASC12L	8031860
	Steckverbinder selbstkonfektionierbar Stecker, M12x1, gewinkelt Lötanschluss	12, A	30V	2A	6...8 mm	max. 0,25 mm ²	WWASC12L	8031861
	Steckverbinder selbstkonfektionierbar Kupplung, M12x1, axial geschirmt Schraub-/Klemmanschluss	4, A	250V	4A	5...8 mm	max. 0,75 mm ²	WAKCS4K	8068908
		5, A	125V	4A	5...8 mm	max. 0,75 mm ²	WAKCS5K	8068910
		8, A	60V	2A	6...8 mm	max. 0,50 mm ²	WAKCS8K	8035193
	Steckverbinder selbstkonfektionierbar Stecker, M12x1, axial geschirmt Schraub-/Klemmanschluss	4, A	250V	4A	5...8 mm	max. 0,75 mm ²	WASCS4K	8068909
		5, A	60V	4A	5...8 mm	max. 0,75 mm ²	WASCS5K	8068911
		8, A	60V	2A	6...8 mm	max. 0,5 mm ²	WASCS8K	8035192
	Steckverbinder selbstkonfektionierbar Kupplung, M12x1, axial geschirmt Lötanschluss	12, A	30V	2A	6...8 mm	max. 0,25 mm ²	WAKCS12L	8052220
	Steckverbinder selbstkonfektionierbar Stecker, M12x1, axial geschirmt Lötanschluss	12, A	30V	2A	6...8 mm	max. 0,25 mm ²	WASCS12L	8037435
	Steckverbinder selbstkonfektionierbar Stecker, M12x1, axial geschirmt Schneid-/Klemmanschluss	4, D	250V	4A	5...9,7 mm	AWG 26/1 - AWG 22/1, AWG 26/7 - AWG 22/7	IE-WASCSY4S	8065954
		8, X	50V _{AC} 60V _{DC}	0,5A	5...9,7 mm	AWG 24/1 - AWG 22/1, AWG 26/7 - AWG 22/7	IE-WASCSX8S	8050231
	Steckverbinder selbstkonfektionierbar Kupplung, M12x1, axial geschirmt Schraub-/Klemmanschluss	5, B	125V	4A	6,5...8,5 mm	max. 0,75 mm ²	PB-WAKCSW4.5K	8031376

		Kopf			Kabeldurchlass	Anschlussquerschnitt	Artikelbezeichnung	Artikel-Nr.
		Pol	U[max]	I[max]				
	Steckverbinder selbstkonfektionierbar Kupplung, M12x1, gewinkelt geschirmt Schraub-/Klemmanschluss	5, B	125V	4A	6...8 mm	max. 0,75 mm ²	PB-WWAKCSW4.5K	8040235
	Steckverbinder selbstkonfektionierbar Stecker, M12x1, axial geschirmt Schraub-/Klemmanschluss	5, B	125V	4A	5...8 mm	max. 0,75 mm ²	PB-WASCSW4.5K	8031375
	Steckverbinder selbstkonfektionierbar Stecker, M12x1, gewinkelt geschirmt Schraub-/Klemmanschluss	5, B	125V	4A	6...8 mm	max. 0,75 mm ²	PB-WWASCSW4.5K	8040236
	Steckverbinder selbstkonfektionierbar Kupplung, M12x1, axial Schraub-/Klemmanschluss	3+PE, S	630V	12A	8...10 mm	1,50 mm ²	PS-WAKC4K	8063400
		4, T	63V	12A	8...10 mm	1,50 mm ²	PT-WAKC4K	8063398
	Steckverbinder selbstkonfektionierbar Stecker, M12x1, axial Schraub-/Klemmanschluss	3+PE, S	630V	12A	8...10 mm	1,50 mm ²	PS-WASC4K	8063399
		4, T	63V	12A	8...10 mm	1,50 mm ²	PT-WASC4K	8063397
	Steckverbinder selbstkonfektionierbar Stecker, Duo-Kabelstecker, M12x1, axial Schraub-/Klemmanschluss	4, A	250V	4A	2 x Ø 2,1-3 mm Ø 4-5 mm	0,75 mm ² AWG18	FSMC4K	8017231
		5, A	125V	4A	2 x Ø 2,1-3 mm Ø 4-5 mm	0,75 mm ² AWG18	FSMC5K	8032825
	Steckverbinder selbstkonfektionierbar Kupplung, M8x1, axial Schraub-/Klemmanschluss	3	60V	4A	3,5...5 mm	max. 0,5 mm ²	SKPC3K	8004833
		4	30V	4A	3,5...5 mm	max. 0,5 mm ²	SKPC4K	8004834
	Steckverbinder selbstkonfektionierbar Stecker, M8x1, axial Schraub-/Klemmanschluss	3	60V	4A	3,5...5 mm	max. 0,5 mm ²	SSPC3K	8004831
		4	30V	4A	3,5...5 mm	max. 0,5 mm ²	SSPC4K	8004832
	Steckverbinder selbstkonfektionierbar Kupplung, M8x1, axial Schneid-/Klemmanschluss	3	32V	4A	2,5...5,1 mm	0,14...0,34 mm ² AWG26...22	SKPC3S	8019721
		4	32V	4A	2,5...5,1 mm	0,14...0,34 mm ² AWG26...22	SKPC4S	8019723
	Steckverbinder selbstkonfektionierbar Stecker, M8x1, axial Schneid-/Klemmanschluss	3	32V	4A	2,5...5,1 mm	0,14...0,34 mm ² AWG26...22	SSPC3S	8019720
		4	32V	4A	2,5...5,1 mm	0,14...0,34 mm ² AWG26...22	SSPC4S	8019722
	Steckverbinder selbstkonfektionierbar Kupplung, M8x1, gewinkelt Lötanschluss	3	32V	4A	3,5...5 mm	0,14...0,34 mm ² AWG26...22	SWKPC3L	8017351
		4	30V	4A	3,5...5 mm	max. 0,25 mm ²	SWKPC4L	8017364
	Steckverbinder selbstkonfektionierbar Stecker, M8x1, gewinkelt Lötanschluss	3	60V	4A	3,5...5 mm	max. 0,25 mm ²	SWSPC3L	8017365
		4	30V	4A	3,5...5 mm	max. 0,25 mm ²	SWSPC4L	8017366

		Kopf						
		Pol	U[max]	I[max]	Kabeldurchlass	Anschlussquerschnitt	Artikelbezeichnung	Artikel-Nr.
	Steckverbinder selbstkonfektionierbar Kupplung, M23x1, axial Lötanschluss	12	150V	8A* 4A**	8...12 mm	Kontakte 10,11,12*: 0,75...1,0 mm ² übrige** 0,5...0,75 mm ²	MKCC12L	8013694
		19	125V	10A* 4A**	10...14 mm	Kontakt 6,12,19*: 0,75...1,0 mm ² übrige** 0,5...0,75 mm ²	MKCC19L	8013696
	Steckverbinder selbstkonfektionierbar Kupplung, M23x1, gewinkelt Lötanschluss	12	150V	8A* 4A**	8...12 mm	Kontakte 9,10,11,12*: 0,75...1,0 mm ² übrige** 0,5...0,75 mm ²	WMKCC12L	8017153
		19	125V	10A* 4A**	10...14 mm	Kontakt 6,12,19*: 0,75...1,0 mm ² übrige** 0,5...0,75 mm ²	WMKCC19L	8017151
	Steckverbinder selbstkonfektionierbar Stecker, RJ45, axial Schneid-/Klemmanschluss	8	50V	1A	5,5...10,5 mm	AWG27/7 – AWG22/7 AWG26/1 – AWG22/1	IE-RJ45SCS8	8065955
 	Dichtung, Steckverbinder selbstkonfektionierbar, M12x1						Set Dichtung 4-6mm	8061922

Nomenklatur Steckverbinder konfektioniert

IE-	S	W	WAS	S	C	X	8.066-	L	- IE-	S	W	WAS	S	X	8.066	/S3500
-----	---	---	-----	---	---	---	--------	---	-------	---	---	-----	---	---	-------	--------

Leitungslänge [m]
 Polzahl.Anschlussbelegung
 X: X-codiert | Y: D-codiert
 geschirmt
 WAS: M12x1 Stecker | RJ45S: Stecker | SP: M8x1 Stecker
 W: gewinkelt | ohne: axial
 M8x1 schraubbar
 Industrial Ethernet
 selbstkonfektionierbar
 geschirmt
 WAS: M12x1 Stecker | RJ45S: Stecker | RJ45SL: light | SP: M8x1 Stecker
 ohne: axial | W: gewinkelt | für RJ45: W0=0°, W3=90°, W6=180°, W9=270°
 M8x1 schraubbar

4D | 8X 4D **ETHERNET POWERLINK** **EtherNet/IP** **EtherCAT** **sercos** the automation bus **UL** us* **RoHS** 50 **PC** **CE**

*nur M12x1_4D, M8x1, Wanddurchführungen

Leitung	Kurzbeschreibung
S3500 PUR	Flexible PUR/PE Datenleitung Industrial Ethernet Cat7 für mittlere Beanspruchungen. Halogenfrei, flammwidrig. Gute Öl- und Chemikalienbeständigkeit, mit UL Style.
S3800 PUR	Flexible PUR/PE Datenleitung Industrial Ethernet Cat5e für mittlere Beanspruchungen. Halogenfrei, flammwidrig, gute Schleppkettentauglichkeit. Gute Öl- und Chemikalienbeständigkeit, mit UL Style.
S2171 PUR	Flexible PUR/PE Datenleitung Industrial Ethernet Cat5e für mittlere Beanspruchungen. Halogenfrei, flammwidrig, gute Schleppkettentauglichkeit. Gute Öl- und Chemikalienbeständigkeit, mit UL Style.
S3400 PUR	Flexible PUR/PE Datenleitung für Industrial-Ethernet-Anwendungen und mittlere Beanspruchungen. Datenübertragungsrate nach Cat5e. Halogenfrei, flammwidrig, gute Schleppkettentauglichkeit. Gute Öl- und Chemikalienbeständigkeit, mit UL-Style.
S4030 PUR	PROFINET 4x2xAWG24/7 Typ C torsionsfähiges Hochgeschwindigkeits-Datenkabel der Übertragungskategorie Cat7.
S4031 PUR	PROFINET 4x2xAWG26/19 Typ C hochflexibles Hochgeschwindigkeits-Datenkabel der Übertragungskategorie Cat6.











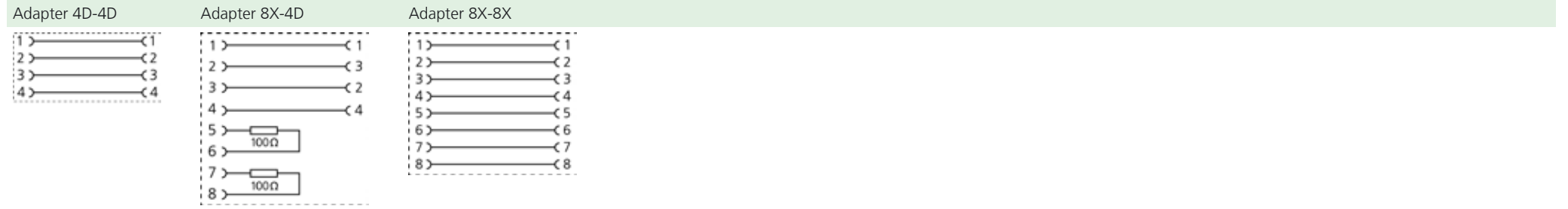

Abbildung im Maßstab ~ 1:1











Industrial Ethernet

Technische Daten	M12x1	M8x1	RJ45	Flansch
Isolationswiderstand	$\geq 10^8 \Omega$	$\geq 10^8 \Omega$	$\geq 10^8 \Omega$	$\geq 10^8 \Omega$
Durchgangswiderstand	$\leq 5 m\Omega$	$\leq 5 m\Omega$	$\leq 5 m\Omega$	$\leq 5 m\Omega$
Umgebungstemperatur	-30°C...+90°C	-30°C...+90°C	-40°C...+70°C	-30°C...+90°C (* +70°C)
Material Kontakte	Metall, vergoldet	Metall, vergoldet	Metall, vergoldet	Metall, vergoldet
Material Kontaktträger	Kunststoff, TPU	Kunststoff, PA	Kunststoff, PC	Kunststoff
Material Griffkörper	Kunststoff, TPU	Kunststoff, TPU	Kunststoff, TPE	Kunststoff, TPU
Material Überwurf	Metall, vernickelt	Metall, vernickelt		
Material Dichtung (Kupplung)				FPM/FKM
Material äußere Dichtung				NBR
Material Flanschgehäuse				Metall, CuZn, vernickelt
Normen	IEC 61076-2-101/-109	IEC 61076-2-104	IEC 60603-7-5	IEC 61076-2-101/-109
Schutzart (montiert)	IP65, IP67, IP68	IP65, IP67, IP68	IP20	IP65, IP67, IP68
Mechanische Lebensdauer	>100 Steckzyklen	>100 Steckzyklen	>750 Steckzyklen	>100 Steckzyklen
Verschmutzungsgrad	2	3/2	1	3/2











Industrial Ethernet-Komponenten von ESCHA sind auf die Spezifikationen der jeweiligen Nutzerorganisation abgestimmt. 4-polig, D-codierte oder 8-polig X-codierte M12x1-Verkabelungslösungen sowie Flansche, Interface-Produkte und industrietaugliche RJ45-Patchcords ermöglichen den Aufbau einer qualitativ hochwertigen Ethernet-Infrastruktur. Unsere 360°-Schirmung mit dem patentierten ESCHA Zwei-Schalen-Schirmkonzept (2SSK) garantiert eine sichere und zuverlässige Datenübertragung (Cat5e, Cat6A).

		Kopf				Leitung			Artikelbezeichnung	L = Leitungslänge*		
		Pol	U[max]	I[max]	Δh [mm]	Material	Farbe	UL		2m / 1m	5m / 2m	10m / 5m
	Anschlussleitung Stecker, M12x1, axial geschirmt Cat5e	4, D	250V	4A		PUR	GN	•	IE-WASSY4.029-L/S2171	8031449	8031450	8031451
				4A		PUR	GN	•	IE-WASSY4.082-L/S3400	8056566	8056567	8056568
	Anschlussleitung Stecker, M12x1, gewinkelt geschirmt Cat5e	4, D	250V	4A		PUR	GN	•	IE-WWASSY4.029-L/S2171	8044087	8041940	8044088
				4A		PUR	GN	•	IE-WWASSY4.082-L/S3400	8056569	8056570	8056571
	Steckverbinder selbstkonfektionierbar Stecker, M12x1, axial geschirmt Cat5e Schneid-/Klemmanschluss	4, D	250V	4A					IE-WASCSY4S	8065954		
	Anschlussleitung Stecker, RJ45, axial geschirmt Cat5e	4	50V	1A		PUR	GN		IE-RJ45SS4.003-L/S2171	8062329	8062330	8062331
				1A		PUR	GN		IE-RJ45SS8.005-L/S3400	8056581	8056582	8056583
	Anschlussleitung Stecker, RJ45, gewinkelt, 0° geschirmt Cat5e	4	50V	1A		PUR	GN		IE-W0RJ45SS8.005-L/S3400	8080677	8080356	8080678
	Anschlussleitung Stecker, RJ45, gewinkelt, 90° geschirmt Cat5e	4	50V	1A		PUR	GN		IE-W3RJ45SS8.005-L/S3400	8080679	8079038	8080680
	Anschlussleitung Stecker, RJ45, gewinkelt, 180° geschirmt Cat5e	4	50V	1A		PUR	GN		IE-W6RJ45SS8.005-L/S3400	8080681	8080682	8080683
	Anschlussleitung Stecker, RJ45, gewinkelt, 270° geschirmt Cat5e	4	50V	1A		PUR	GN		IE-W9RJ45SS8.005-L/S3400	8080684	8080802	8080994











* Unsere Standardleitungslängen sind 2m, 5m oder 10m für Anschlussleitungen und 1m, 2m oder 5m für Verbindungsleitungen. Die Litzenlänge bei Flanschen beträgt 0,5m (POWER 0,2m). Alle anderen Leitungs- und Litzenlängen liefern wir Ihnen gern auf Anfrage.

		Kopf				Leitung			Artikelbezeichnung	L = Leitungslänge*		
		Pol	U[max]	I[max]	Δh[mm]	Material	Farbe	UL		2m / 1m	5m / 2m	10m / 5m
	Steckverbinder selbstkonfektionierbar Stecker, RJ45, axial Cat6A Schneid-/Klemmanschluss	8	50V	1A					IE-RJ45SCS8	8065955		
	Flansch Anschlussleitung Kupplung, M12x1, axial geschirmt Cat5e Leitung Vorderwandmontage	4, D	250V	4A		PUR	GN		IE-FKSY4.029-L/16/S2171/S3941	8063614	8063615	8063616
	Flansch Kupplung, M12x1, axial Cat5e Printanschluss Hinterwandmontage	4, D	250V	4A	1,0...2,5				IE-FHM12KUD4-P/M12/S3525	8074847		
				4A	2,5...4,0				IE-FHM12KUD4-P/M12/S3540	8074846		
				4A	4,0...5,0				IE-FHM12KUD4-P/M12/S3550	8072578		
	Flansch Kupplung, M12x1, gewinkelt geschirmt Printanschluss Hinterwandmontage	4, D	250V	4A	1,0...2,5				IE-WFKFSY4-P/12/S3525	8050282		
				4A	2,5...4,0				IE-WFKFSY4-P/12/S3540	8050284		
				4A	4,0...5,0				IE-WFKFSY4-P/12/S3550	8050285		
	Flansch Kupplung, M12x1, axial Litzenanschluss Hinterwandmontage	4, D	250V	4A					IE-FHM12KUD4.029-0,5/M16	8072504		
	Flansch Stecker, M12x1, axial Litzenanschluss Hinterwandmontage	4, D	250V	4A					IE-FHM12SUD4.029-0,5/M16	8072520		
	Flansch Kupplung, M12x1, axial Litzenanschluss Vorderwandmontage	4, D	250V	4A					IE-FVM12KUD4.029-0,5/M16	8072505		
	Flansch Kupplung, M12x1, axial Litzenanschluss Vorderwandmontage, positionierbar	4, D	250V	4A					IE-FVM12KUD4.029-0,5/M16/S520	8077905		
	Flansch Stecker, M12x1, axial Litzenanschluss Vorderwandmontage	4, D	250V	4A					IE-FVM12SUD4.029-0,5/M16	8072521		
	Flansch Stecker, M12x1, axial Litzenanschluss Vorderwandmontage, positionierbar	4, D	250V	4A					IE-FVM12SUD4.029-0,5/M16/S520	8077968		



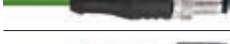



* Unsere Standardleitungslängen sind 2m, 5m oder 10m für Anschlussleitungen und 1m, 2m oder 5m für Verbindungsleitungen. Die Litzenlänge bei Flanschen beträgt 0,5m (POWER 0,2m). Alle anderen Leitungs- und Litzenlängen liefern wir Ihnen gern auf Anfrage.

		Kopf				Leitung			Artikelbezeichnung	L = Leitungslänge*		
		Pol	U[max]	I[max]	Δh[mm]	Material	Farbe	UL		2m / 1m	5m / 2m	10m / 5m
	Flansch Kupplung, M12x1, axial Cat5e Printanschluss Hinterwandmontage	4, D	250V	4A	1,0...5,0				IE-FHM12KUD4-P/M16	8072576		
	Flansch Stecker, M12x1, axial Cat5e Printanschluss Hinterwandmontage	4, D	250V	4A	1,0...5,0				IE-FHM12SUD4-P/M16	8072586		
	Flansch Anschlussleitung Kupplung, M12x1, axial geschirmt Cat5e Leitung Hinterwandmontage	4, D	250V	4A		PUR	GN		IE-FKFDSY4.029-L/16/S2171	8063608	8063609	8063610
				4A		PUR	GN		IE-FKFDSY4.082-L/16/S3400	8064034	8064035	8064036
	Flansch Anschlussleitung Kupplung, M12x1, gewinkelt geschirmt Cat5e Leitung Hinterwandmontage	4, D	250V	4A		PUR	GN		IE-WKFDSY4.029-L/16/S2171	8063611	8063612	8063613
	Anschlussleitung Stecker, M8x1, axial geschirmt Cat5e	4	30V	4A		PUR	GN		IE-SSPS4.027-L/S3400	8055529	8055530	8055531
	Anschlussleitung Stecker, M8x1, gewinkelt geschirmt Cat5e	4	30V	4A		PUR	GN		IE-SWSPS4.027-L/S3400	8055789	8055790	8055791
	Verbindungsleitung Stecker, M12x1, axial Stecker, M12x1, axial geschirmt Cat5e	4, D	250V	4A		PUR	GN	•	IE-WASSY4.029-L-IE-WASSY4.029/S2171	8031558	8031560	8031561
		4, D		4A		PUR	GN	•	IE-WASSY4.082-L-IE-WASSY4.082/S3400	8056557	8056558	8056559
	Verbindungsleitung Stecker, M12x1, axial Stecker, RJ45, axial geschirmt Cat5e	4, D	50V	1A		PUR	GN		IE-WASSY4.029-L-IE-RJ45SS4.003/S2171	8061081	8061082	8061083
		4		1A		PUR	GN		IE-WASSY4.082-L-IE-RJ45SS8.005/S3400	8056572	8056573	8056574
	Verbindungsleitung Stecker, M12x1, axial Stecker, M8x1, axial geschirmt Cat5e	4, D	60V	4A		PUR	GN		IE-WASSY4.082-L-IE-SSPS4.027/S3400	8055552	8055553	8055554
		4										
	Flansch Verbindungsleitung Kupplung, M12x1, axial Stecker, RJ45, axial geschirmt Cat5e	4, D	50V	1A		PUR	GN		IE-FKFDSY4.029-L-IE-RJ45SS4.003/S2171	8064023	8064024	8064025
				1A		PUR	GN		IE-FKFDSY4.082-L-IE-RJ45SS8.005/S3400	8060876	8063625	8063626













* Unsere Standardleitungslängen sind 2m, 5m oder 10m für Anschlussleitungen und 1m, 2m oder 5m für Verbindungsleitungen. Die Litzenlänge bei Flanschen beträgt 0,5m (POWER 0,2m). Alle anderen Leitungs- und Litzenlängen liefern wir Ihnen gern auf Anfrage.

		Kopf				Leitung			Artikelbezeichnung	L = Leitungslänge*		
		Pol	U[max]	I[max]	Δh[mm]	Material	Farbe	UL		2m / 1m	5m / 2m	10m / 5m
	Flansch Verbindungsleitung Kupplung, M12x1, gewinkelt Stecker, RJ45, axial geschirmt Cat5e	4, D	50V	1A		PUR	GN		IE-WFKFDSY4.082-L-IE-RJ45SS8.005/S3400	8069853	8069854	8069855
	Verbindungsleitung Stecker, M12x1, gewinkelt Stecker, M12x1, axial geschirmt Cat5e	4, D	250V	4A		PUR	GN	•	IE-WWASSY4.029-L-IE-WASSY4.029/S2171	8046398	8044089	8044090
		4, D		4A		PUR	GN	•	IE-WWASSY4.082-L-IE-WASSY4.082/S3400	8056563	8056564	8056565
	Verbindungsleitung Stecker, M12x1, gewinkelt Stecker, RJ45, axial geschirmt Cat5e	4, D	50V	1A		PUR	GN		IE-WWASSY4.029-L-IE-RJ45SS4.003/S2171	8062317	8062318	8062319
		4		1A		PUR	GN		IE-WWASSY4.082-L-IE-RJ45SS8.005/S3400	8056575	8056576	8056577
	Verbindungsleitung Stecker, M12x1, gewinkelt Stecker, M12x1, gewinkelt geschirmt Cat5e	4, D	250V	4A		PUR	GN	•	IE-WWASSY4.029-L-IE-WWASSY4.029/S2171	8046893	8036902	8036903
		4, D		4A		PUR	GN	•	IE-WWASSY4.082-L-IE-WWASSY4.082/S3400	8056560	8056561	8056562
	Verbindungsleitung Stecker, RJ45, axial geschirmt Cat5e	4	50V	1A		PUR	GN		IE-RJ45SS4.003-L-IE-RJ45SS4.003/S2171	8062323	8062324	8065056
		4		1A		PUR	GN		IE-RJ45SS8.005-L-IE-RJ45SS8.005/S3400	8056578	8056579	8056580
	Verbindungsleitung Stecker, RJ45, gewinkelt, 0° Stecker, RJ45, axial geschirmt Cat5e	4	50V	1A		PUR	GN		IE-W0RJ45SS8.005-L-IE-RJ45SS8.005/S3400	8080803	8080804	8080752
		4										













* Unsere Standardleitungslängen sind 2m, 5m oder 10m für Anschlussleitungen und 1m, 2m oder 5m für Verbindungsleitungen. Die Litzenlänge bei Flanschen beträgt 0,5m (POWER 0,2m). Alle anderen Leitungs- und Litzenlängen liefern wir Ihnen gern auf Anfrage.

		Kopf				Leitung			Artikelbezeichnung	L = Leitungslänge*		
		Pol	U[max]	I[max]	Δh [mm]	Material	Farbe	UL		2m / 1m	5m / 2m	10m / 5m
	Verbindungsleitung Stecker, RJ45, gewinkelt, 90° Stecker, RJ45, axial geschirmt Cat5e	4 4	50V	1A		PUR	GN		IE-W3RJ45SS8.005-L-IE-RJ45SS8.005/S3400	8080805	8080806	8080753
	Verbindungsleitung Stecker, RJ45, gewinkelt, 180° Stecker, RJ45, axial geschirmt Cat5e	4 4	50V	1A		PUR	GN		IE-W6RJ45SS8.005-L-IE-RJ45SS8.005/S3400	8080807	8080995	8080754
	Verbindungsleitung Stecker, RJ45, gewinkelt, 270° Stecker, RJ45, axial geschirmt Cat5e	4 4	50V	1A		PUR	GN		IE-W9RJ45SS8.005-L-IE-RJ45SS8.005/S3400	8080808	8080997	8080755
	Verbindungsleitung Stecker, RJ45 light, axial Stecker, RJ45 light, axial geschirmt Cat5e	4 4	50V	1A		PUR	GN		IE-RJ45SLS8.005-L-IE-RJ45SLS8.005/S3400	8069789	8071964	8075806
	Verbindungsleitung Kupplung, M8x1, axial Stecker, M8x1, axial geschirmt Cat5e	4 4	60V	4A		PUR	GN		IE-SKPS4.027-L-IE-SSPS4.027/S3400	8055535	8055537	8055538
	Verbindungsleitung Stecker, M8x1, axial Stecker, M8x1, axial geschirmt Cat5e	4 4	60V	4A		PUR	GN		IE-SSPS4.027-L-IE-SSPS4.027/S3400	8055532	8055533	8055534
	Verbindungsleitung Stecker, M8x1, axial Stecker, RJ45, axial geschirmt Cat5e	4 4	50V	1A		PUR	GN		IE-SSPS4.027-L-IE-RJ45SS8.005/S3400	8055536	8055539	8055540





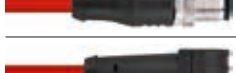



* Unsere Standardleitungslängen sind 2m, 5m oder 10m für Anschlussleitungen und 1m, 2m oder 5m für Verbindungsleitungen. Die Litzenlänge bei Flanschen beträgt 0,5m (POWER 0,2m). Alle anderen Leitungs- und Litzenlängen liefern wir Ihnen gern auf Anfrage.

		Kopf				Leitung			Artikelbezeichnung	L = Leitungslänge*		
		Pol	U[max]	I[max]	Δh[mm]	Material	Farbe	UL		2m / 1m	5m / 2m	10m / 5m
	Verbindungsleitung Stecker, M8x1, gewinkelt	4	60V	4A		PUR	GN		IE-SWSPS4.027-L-IE-SSPS4.027/S3400	8055795	8055796	8055797
	Stecker, M8x1, axial geschirmt	4										
	Cat5e											
	Verbindungsleitung Stecker, M8x1, gewinkelt	4	60V	4A		PUR	GN		IE-SWSPS4.027-L-IE-SWSPS4.027/S3400	8055801	8055802	8055804
	Stecker, M8x1, gewinkelt geschirmt	4										
	Cat5e											
	Anschlussleitung Stecker, M12x1, axial geschirmt	4, D	250V	4A		PUR	RD	•	IE-WASSY4.029-L/S3800	8055493	8055494	8055495
	Anschlussleitung Stecker, M12x1, gewinkelt geschirmt	4, D	250V	4A		PUR	RD	•	IE-WWASSY4.029-L/S3800	8055499	8055500	8055501
	Steckverbinder selbstkonfektionierbar Stecker, M12x1, axial geschirmt	4, D	250V	4A					IE-WASCSY4S	8065954		
	Schneid-/Klemmanschluss											
	Anschlussleitung Stecker, RJ45, axial geschirmt	4	50V	1A		PUR	RD		IE-RJ45SS4.003-L/S3800	8062332	8062333	8062334
	Steckverbinder selbstkonfektionierbar Stecker, RJ45, axial	8	50V	1A					IE-RJ45SCS8	8065955		
	Cat6A Schneid-/Klemmanschluss											
	Flansch Anschlussleitung Kupplung, M12x1, axial geschirmt	4, D	250V	4A		PUR	RD		IE-FKSY4.029-L/16/S3800/S3801	8063605	8063606	8063607
	Cat5e Leitung Vorderwandmontage											
	Flansch Kupplung, M12x1, axial	4, D	250V	4A					IE-FKFDY4-P/16/S38	8055849		
	Cat5e Printanschluss Hinterwandmontage											









* Unsere Standardleitungslängen sind 2m, 5m oder 10m für Anschlussleitungen und 1m, 2m oder 5m für Verbindungsleitungen. Die Litzenlänge bei Flanschen beträgt 0,5m (POWER 0,2m). Alle anderen Leitungs- und Litzenlängen liefern wir Ihnen gern auf Anfrage.

		Kopf				Leitung			Artikelbezeichnung	L = Leitungslänge*		
		Pol	U[max]	I[max]	Δh[mm]	Material	Farbe	UL		2m / 1m	5m / 2m	10m / 5m
	Flansch	4, D	250V	4A	1,0...2,5	PUR	RD	•	IE-WFKFSY4-P/12/S3825	8055850		
	Kupplung, M12x1, gewinkelt geschirmt			4A	2,5...4,0				IE-WFKFSY4-P/12/S3840	8055851		
	Cat5e Printanschluss Hinterwandmontage			4A	4,0...5,0				IE-WFKFSY4-P/12/S3850	8055852		
	Flansch Anschlussleitung Kupplung, M12x1, axial geschirmt Cat5e Leitung Hinterwandmontage	4, D	250V	4A		PUR	RD		IE-FKFDSY4.029-L/16/S3800/S38	8063599	8063600	8063601
	Flansch Anschlussleitung Kupplung, M12x1, gewinkelt geschirmt Cat5e Leitung Hinterwandmontage	4, D	250V	4A		PUR	RD		IE-WFKFDSY4.029-L/16/S3800/S38	8063602	8063603	8063604
 	Verbindungsleitung Stecker, M12x1, axial geschirmt Cat5e	4, D 4, D	250V	4A		PUR	RD	•	IE-WASSY4.029-L-IE-WASSY4.029/S3800	8055496	8055497	8055498
 	Verbindungsleitung Stecker, M12x1, axial geschirmt Cat5e	4, D 4	50V	1A		PUR	RD		IE-WASSY4.029-L-IE-RJ45SS4.003/S3800	8061084	8061085	8061086
 	Flansch Verbindungsleitung Kupplung, M12x1, axial geschirmt Cat5e	4, D	50V	1A		PUR	RD		IE-FKFDSY4.029-L-IE-RJ45SS4.003/S3800	8064026	8064027	8064028
 	Verbindungsleitung Stecker, M12x1, gewinkelt geschirmt Cat5e	4, D 4, D	250V	4A		PUR	RD	•	IE-WWASSY4.029-L-IE-WASSY4.029/S3800	8055502	8055503	8055504
 	Verbindungsleitung Stecker, M12x1, gewinkelt geschirmt Cat5e	4, D 4	50V	1A		PUR	RD		IE-WWASSY4.029-L-IE-RJ45SS4.003/S3800	8062320	8062321	8062322















* Unsere Standardleitungslängen sind 2m, 5m oder 10m für Anschlussleitungen und 1m, 2m oder 5m für Verbindungsleitungen. Die Litzenlänge bei Flanschen beträgt 0,5m (POWER 0,2m). Alle anderen Leitungs- und Litzenlängen liefern wir Ihnen gern auf Anfrage.

		Kopf				Leitung			Artikelbezeichnung	L = Leitungslänge*		
		Pol	U[max]	I[max]	Δh[mm]	Material	Farbe	UL		2m / 1m	5m / 2m	10m / 5m
	Verbindungsleitung Stecker, M12x1, gewinkelt Stecker, M12x1, gewinkelt geschirmt Cat5e	4, D 4, D	250V	4A		PUR	RD	•	IE-WWASSY4.029-L-IE-WWASSY4.029/S3800	8055505	8055506	8055507
	Verbindungsleitung Stecker, RJ45, axial Stecker, RJ45, axial geschirmt Cat5e	4 4	50V	1A		PUR	RD		IE-RJ45SS4.003-L-IE-RJ45SS4.003/S3800	8062326	8062327	8062328
	Adapter Kupplung, M12x1, axial Kupplung, M12x1, axial geschirmt Cat5e	4, D 4, D	250V	4A					IE-WAKSY4-IE-WAKSY4	8065952		
	Adapter Kupplung, M12x1, axial Kupplung, M12x1, axial geschirmt Cat5e	8, X 4, D	50V _{AC} 60V _{DC}	0,5A					IE-WAKSX8-IE-WAKSY4	8065950		
	Wanddurchführung Kupplung, M12x1, axial Kupplung, RJ45, axial geschirmt Cat5e Hinterwandmontage	4, D 8	50V _{AC/DC}	0,2A					IE-FKFDSY4-RJ45KS	8069793		
	Wanddurchführung Kupplung, M12x1, gewinkelt Kupplung, RJ45, axial geschirmt Cat5e Hinterwandmontage	4, D 8	50V _{AC/DC}	0,2A					IE-WFKFDSY4-RJ45KS	8069794		
	Anschlussleitung Stecker, M12x1, axial geschirmt Cat6A	8, X	50V _{AC} 60V _{DC}	0,5A		PUR	GN		IE-WASSX8.066-L/S3500	8049457	8049458	8049459
	Anschlussleitung Stecker, M12x1, axial geschirmt Cat6A	8, X	50V _{AC} 60V _{DC}	0,5A		PUR	GN		IE-WASSX8.066-L/S4030	8063566	8063567	8063568
				0,5A		PUR	GN		IE-WASSX8.066-L/S4031	8063578	8063579	8063580









* Unsere Standardleitungslängen sind 2m, 5m oder 10m für Anschlussleitungen und 1m, 2m oder 5m für Verbindungsleitungen. Die Litzenlänge bei Flanschen beträgt 0,5m (POWER 0,2m). Alle anderen Leitungs- und Litzenlängen liefern wir Ihnen gern auf Anfrage.

		Kopf				Leitung			Artikelbezeichnung	L = Leitungslänge*		
		Pol	U[max]	I[max]	Δh[mm]	Material	Farbe	UL		2m / 1m	5m / 2m	10m / 5m
	Anschlussleitung Stecker, M12x1, gewinkelt geschirmt Cat6A	8, X	50V _{AC} 60V _{DC}	0,5A		PUR	GN		IE-WWASSX8.066-L/S3500	8055441	8055442	8055443
	Anschlussleitung Stecker, RJ45, axial geschirmt Cat6A	8	50V	1A		PUR	GN		IE-RJ45SS8.002-L/S3500	8052214	8052215	8052216
	Steckverbinder selbstkonfektionierbar Stecker, RJ45, axial Cat6A Schneid-/Klemmanschluss	8	50V	1A					IE-RJ45SCS8	8065955		
	Flansch Kupplung, M12x1, axial geschirmt Cat6A Printanschluss Vorderwandmontage	8, X	50V _{AC} 60V _{DC}	0,5A	0,9...2,5				IE-FKDSX8-P/12	8050232		
	Flansch Kupplung, M12x1, axial geschirmt Cat6A Printanschluss Vorderwandmontage modular	8, X	50V _{AC} 60V _{DC}	0,5A	0,9...2,5				IE-FKDHSX8-P/12	8053483		
	Flansch Kupplung, M12x1, axial geschirmt Cat6A Printanschluss Hinterwandmontage	8, X	50V _{AC} 60V _{DC}	0,5A	0,9...2,5				IE-FKFDX8-P	8053484		
	Flansch Kupplung, M12x1, axial geschirmt Cat6A Printanschluss Hinterwandmontage modular	8, X	50V _{AC} 60V _{DC}	0,5A	0,9...2,5				IE-FKFDHSX8-P	8053485		
	Flansch Kupplung, M12x1, gewinkelt geschirmt Cat6A Printanschluss Hinterwandmontage	8, X	50V _{AC} 60V _{DC}	0,5A	1,0...2,5				IE-WFKFSX8-P/12/S3525	8059345		
				0,5A	2,5...4,0				IE-WFKFSX8-P/12/S3540	8059346		
				0,5A	4,0...5,0				IE-WFKFSX8-P/12/S3550	8059347		
	Flansch Kupplung, M12x1, axial geschirmt Cat6A Printanschluss Einbaukupplung	8, X	50V _{AC} 60V _{DC}	0,5A					IE-EKSX8P	8050233		

* Unsere Standardleitungslängen sind 2m, 5m oder 10m für Anschlussleitungen und 1m, 2m oder 5m für Verbindungsleitungen. Die Litzenlänge bei Flanschen beträgt 0,5m (POWER 0,2m). Alle anderen Leitungs- und Litzenlängen liefern wir Ihnen gern auf Anfrage.

		Kopf				Leitung			Artikelbezeichnung	L = Leitungslänge*		
		Pol	U[max]	I[max]	Δh[mm]	Material	Farbe	UL		2m / 1m	5m / 2m	10m / 5m
	Flansch Anschlussleitung Kupplung, M12x1, axial geschirmt Cat6A Leitung Hinterwandmontage	8, X	50V _{AC} 60V _{DC}	0,5A		PUR	GN		IE-FKFDSX8.066-L/S3500	8061148	8061149	8061150
	Flansch Anschlussleitung Kupplung, M12x1, axial geschirmt Cat6A Leitung Hinterwandmontage	8, X	50V _{AC} 60V _{DC}	0,5A		PUR	GN		IE-FKFDSX8.066-L/S4030	8063572	8063573	8063574
				0,5A		PUR	GN		IE-FKFDSX8.066-L/S4031	8063584	8063585	8063586
	Verbindungsleitung Stecker, M12x1, axial geschirmt Cat6A	8, X	50V _{AC} 60V _{DC}	0,5A		PUR	GN		IE-WASSX8.066-L-IE-WASSX8.066/S3500	8048865	8049460	8049461
		8, X										
	Verbindungsleitung Stecker, M12x1, axial geschirmt Cat6A	8, X	50V _{AC} 60V _{DC}	0,5A		PUR	GN		IE-WASSX8.066-L-IE-WASSX8.066/S4030	8063563	8063564	8063565
				0,5A		PUR	GN		IE-WASSX8.066-L-IE-WASSX8.066/S4031	8063575	8063576	8063577
	Verbindungsleitung Stecker, M12x1, axial geschirmt Cat6A	8, X	50V	1A		PUR	GN		IE-WASSX8.066-L-IE-RJ45SS8.002/S3500	8053444	8053288	8053289
		8										
	Flansch Verbindungsleitung Kupplung, M12x1, axial Stecker, M12x1, axial Cat6A	8, X	50V _{AC} 60V _{DC}	0,5A		PUR	GN		IE-FKFDSX8.066-L-IE-WASSX8.066/S3500	8061289	8061290	8061291
		8, X										
	Flansch Verbindungsleitung Kupplung, M12x1, axial Stecker, M12x1, axial Cat6A	8, X	50V _{AC} 60V _{DC}	0,5A		PUR	GN		IE-FKFDSX8.066-L-IE-WASSX8.066/S4030	8063569	8063570	8063571
				0,5A		PUR	GN		IE-FKFDSX8.066-L-IE-WASSX8.066/S4031	8063581	8063582	8063583
	Flansch Verbindungsleitung Kupplung, M12x1, axial Stecker, RJ45, axial geschirmt Cat6A	8, X	50V	1A		PUR	GN		IE-FKFDSX8.066-L-IE-RJ45SS8.002/S3500	8061295	8061296	8061297
		8										
	Verbindungsleitung Stecker, M12x1, gewinkelt Stecker, M12x1, axial geschirmt Cat6A	8, X	50V _{AC} 60V _{DC}	0,5A		PUR	GN		IE-WWASSX8.066-L-IE-WASSX8.066/S3500	8055444	8055445	8055446
		8, X										

* Unsere Standardleitungslängen sind 2m, 5m oder 10m für Anschlussleitungen und 1m, 2m oder 5m für Verbindungsleitungen. Die Litzenlänge bei Flanschen beträgt 0,5m (POWER 0,2m). Alle anderen Leitungs- und Litzenlängen liefern wir Ihnen gern auf Anfrage.

		Kopf				Leitung			Artikelbezeichnung	L = Leitungslänge*		
		Pol	U[max]	I[max]	Δh[mm]	Material	Farbe	UL		2m / 1m	5m / 2m	10m / 5m
	Verbindungsleitung Stecker, M12x1, gewinkelt Stecker, RJ45, axial geschirmt Cat6A	8, X 8	50V	1A		PUR	GN		IE-WWASSX8.066-L-IE-RJ45SS8.002/S3500	8055447	8055448	8055449
	Verbindungsleitung Stecker, RJ45, axial Stecker, RJ45, axial geschirmt Cat6A	8 8	50V	1A		PUR	GN		IE-RJ45SS8.002-L-IE-RJ45SS8.002/S3500	8052205	8048829	8048830
	Adapter Kupplung, M12x1, axial Kupplung, M12x1, axial geschirmt Cat6A	8, X 8, X	50V _{AC} 60V _{DC}	0,5A					IE-WAKSX8-IE-WAKSX8	8065951		
	Wanddurchführung Kupplung, M12x1, gewinkelt Kupplung, RJ45, axial geschirmt Cat6A Hinterwandmontage	8, X 8	50V _{AC} 60V _{DC}	0,5A					IE-WFKFDSX8-RJ45KS	8055774		
	Wanddurchführung Kupplung, M12x1, axial Kupplung, RJ45, axial geschirmt Cat6A Hinterwandmontage	8, X 8	50V _{AC} 60V _{DC}	0,5A					IE-FKFDSX8-RJ45KS	8055773		
	Leitungsverbinder Cat7 Schneid-/Klemmanschluss	8	60V _{DC}	0,5A					IE-LVCS8	8055776		
	Befestigungswinkel für Industrial Ethernet Adapter									8065953		
	Adapter Kupplung, RJ45, axial Kupplung, RJ45, axial Cat6E	8 8	50V _{AC/DC}	1A					IE-RJ45KS-RJ45KS	8076629		

* Unsere Standardleitungslängen sind 2m, 5m oder 10m für Anschlussleitungen und 1m, 2m oder 5m für Verbindungsleitungen. Die Litzenlänge bei Flanschen beträgt 0,5m (POWER 0,2m). Alle anderen Leitungs- und Litzenlängen liefern wir Ihnen gern auf Anfrage.

		Kopf				Leitung			UL	Artikelbezeichnung	L = Leitungslänge*		
		Pol	U[max]	I[max]	Δh [mm]	Material	Farbe	2m / 1m			5m / 2m	10m / 5m	
	Steckverbinder selbstkonfektionierbar Stecker, M12x1, axial geschirmt Cat6A Schneid-/Klemmanschluss	8, X	50V _{AC} 60V _{DC}	0,5A						IE-WASCSX8S	8050231		

* Unsere Standardleitungslängen sind 2m, 5m oder 10m für Anschlussleitungen und 1m, 2m oder 5m für Verbindungsleitungen. Die Litzenlänge bei Flanschen beträgt 0,5m (POWER 0,2m). Alle anderen Leitungs- und Litzenlängen liefern wir Ihnen gern auf Anfrage.

Nomenklatur

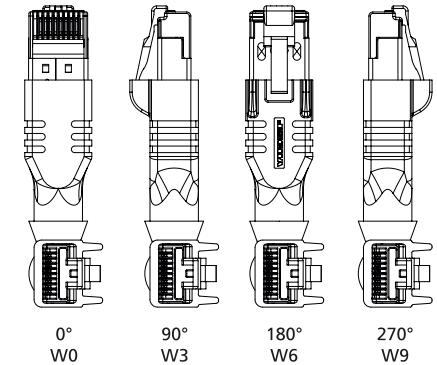
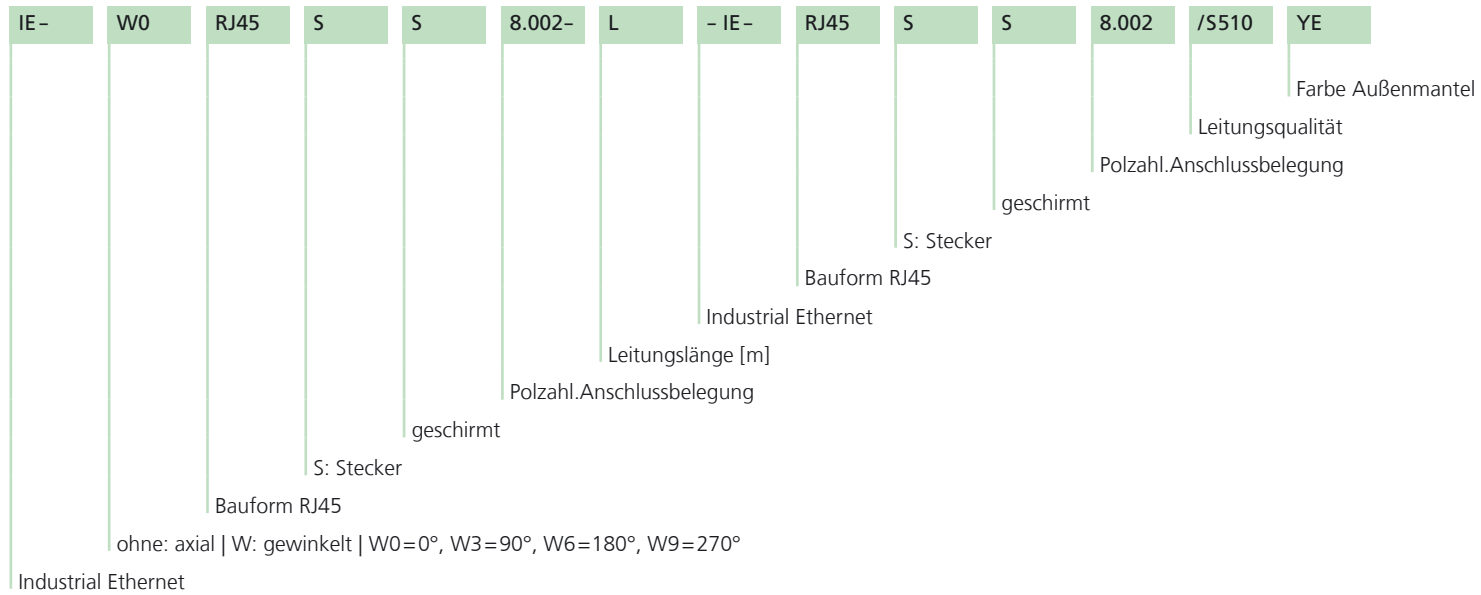

RJ45 Patchcords



Leitung	Kurzbeschreibung
S510 PVC	Flexible PVC/PE Patchcord-Leitung für Industrial-Ethernet-Anwendungen und mittlere Beanspruchungen. Datenübertragungsrate nach Cat5e.
S620 LSZH/FRNC	Flexible FRNC/PE Patchcord-Leitung für Industrial-Ethernet-Anwendungen und mittlere Beanspruchungen. Datenübertragungsrate nach Cat7. Halogenfrei, flammwidrig, mit UL-Style.
S3400 PUR	Flexible PUR/PE Datenleitung für Industrial-Ethernet-Anwendungen und mittlere Beanspruchungen. Datenübertragungsrate nach Cat5e. Halogenfrei, flammwidrig, gute Schleppkettentauglichkeit. Gute Öl- und Chemikalienbeständigkeit, mit UL-Style.











Abbildung im Maßstab ~ 1:1

RJ45 Patchcords

Technische Daten	RJ45
Isolationswiderstand	$\geq 10^8 \Omega$
Durchgangswiderstand	$\leq 5 \text{ m}\Omega$
Umgebungstemperatur	-40°C...+70°C
Material Kontakte	Metall, CuZn, vergoldet
Material Kontaktträger	Kunststoff, PC, transparent
Material Griffkörper	Kunststoff, TPE, BK
Normen	IEC 60603-7-5
Schutzart (montiert)	IP20
Mechanische Lebensdauer	>750 Steckzyklen
Verschmutzungsgrad	1

Unsere RJ45-Patchcords eignen sich sowohl für den industriellen Einsatz, als auch für eine strukturierte Gebäudeverkabelung. Wir haben zwei Produktserien aufgelegt: einmal mit PVC-Leitungsqualität für Cat5e-Anwendungen und einmal mit FRNC-Leitungsqualität für Cat6A-Anwendungen. Hierbei handelt es sich jeweils um vierpaarige AWG26-Leitungen. Die RJ45-Patchcords sind IP20 getestet.

					L = Leitungslänge							
		Farbe	UL	Artikelbezeichnung	0,3m	0,5m	1m	2m	5m	7,5m	10m	12,5m
	Verbindungsleitung Cat5e Stecker, RJ45, axial Stecker, RJ45, axial T568B	GY		IE-RJ45SS8.002-L-IE-RJ45SS8.002/S510GY	8068494	8068495	8068496	8068497	8068499	8068501	8068502	8068503
	Verbindungsleitung Cat5e Stecker, RJ45, axial Stecker, RJ45, axial T568B	RD		IE-RJ45SS8.002-L-IE-RJ45SS8.002/S510RD	8068540	8068541	8068542	8068543	8068545	8068546	8068547	8068548
	Verbindungsleitung Cat5e Stecker, RJ45, axial Stecker, RJ45, axial T568B	YE		IE-RJ45SS8.002-L-IE-RJ45SS8.002/S510YE	8068524	8068525	8068526	8068527	8068529	8068530	8068531	8068532
	Verbindungsleitung Cat5e Stecker, RJ45, axial Stecker, RJ45, axial T568B	BU		IE-RJ45SS8.002-L-IE-RJ45SS8.002/S510BU	8068556	8068557	8068558	8068559	8068560	8068561	8068562	8068563
	Verbindungsleitung Cat5e Stecker, RJ45, axial Stecker, RJ45, axial T568B	GN		IE-RJ45SS8.002-L-IE-RJ45SS8.002/S510GN	8068571	8068572	8068573	8068574	8068576	8068577	8068578	8068579
	Verbindungsleitung Cat6A Stecker, RJ45, axial Stecker, RJ45, axial T568B	BK	•	IE-RJ45SS8.002-L-IE-RJ45SS8.002/S620BK	8076929	8077188	8077189	8077190	8077192	8077193	8077194	8077195
	Verbindungsleitung Cat6A Stecker, RJ45, axial Stecker, RJ45, axial T568B	GY	•	IE-RJ45SS8.002-L-IE-RJ45SS8.002/S620GY	8077337	8077338	8077339	8077340	8077342	8077343	8077344	8077345
	Verbindungsleitung Cat6A Stecker, RJ45, axial Stecker, RJ45, axial T568B	RD	•	IE-RJ45SS8.002-L-IE-RJ45SS8.002/S620RD	8077287	8077288	8077289	8077290	8077292	8077293	8077294	8077295
	Verbindungsleitung Cat6A Stecker, RJ45, axial Stecker, RJ45, axial T568B	YE	•	IE-RJ45SS8.002-L-IE-RJ45SS8.002/S620YE	8077320	8077321	8077322	8077323	8077325	8077326	8077327	8077328
	Verbindungsleitung Cat6A Stecker, RJ45, axial Stecker, RJ45, axial T568B	BU	•	IE-RJ45SS8.002-L-IE-RJ45SS8.002/S620BU	8077304	8077305	8077306	8077307	8077309	8077310	8077311	8077312

					L = Leitungslänge							
		Farbe	UL	Artikelbezeichnung	0,3m	0,5m	1m	2m	5m	7,5m	10m	12,5m
	Verbindungsleitung Cat6A Stecker, RJ45, axial Stecker, RJ45, axial T568B	GN	•	IE-RJ45SS8.002-L-IE-RJ45SS8.002/S620GN	8077354	8077465	8077466	8077467	8077469	8077470	8077471	8077472
	Verbindungsleitung Cat6A Stecker, RJ45, axial Stecker, RJ45, axial Crossover	BK	•	IE-RJ45SS8.002-L-IE-RJ45SS8.012/S620BK	8076930	8077149	8077479	8077480	8077482	8077483	8077484	8077485
	Verbindungsleitung Cat6A Stecker, RJ45, axial Stecker, RJ45, axial Crossover	GY	•	IE-RJ45SS8.002-L-IE-RJ45SS8.012/S620GY	8077555	8077556	8077557	8077558	8077559	8077561	8077562	8077563
	Verbindungsleitung Cat6A Stecker, RJ45, axial Stecker, RJ45, axial Crossover	RD	•	IE-RJ45SS8.002-L-IE-RJ45SS8.012/S620RD	8077492	8077493	8077494	8077495	8077497	8077498	8077499	8077500
	Verbindungsleitung Cat6A Stecker, RJ45, axial Stecker, RJ45, axial Crossover	YE	•	IE-RJ45SS8.002-L-IE-RJ45SS8.012/S620YE	8077510	8077511	8077512	8077514	8077515	8077516	8077517	8077518
	Verbindungsleitung Cat6A Stecker, RJ45, axial Stecker, RJ45, axial Crossover	BU	•	IE-RJ45SS8.002-L-IE-RJ45SS8.012/S620BU	8077540	8077541	8077542	8077543	8077545	8077546	8077547	8077548
	Verbindungsleitung Cat6A Stecker, RJ45, axial Stecker, RJ45, axial Crossover	GN	•	IE-RJ45SS8.002-L-IE-RJ45SS8.012/S620GN	8077525	8077526	8077527	8077528	8077530	8077531	8077532	8077533
	Verbindungsleitung Cat5e Stecker, RJ45 light, axial Stecker, RJ45 light, axial Industrial	GN		IE-RJ45SL8.005-L-IE-RJ45SL8.005/S3400	8070278	8070956	8069789	8071964	8075806	8075807	8075808	8075809
	Verbindungsleitung Cat5e Stecker, RJ45, gewinkelt, 0° Stecker, RJ45, axial Industrial	GN		IE-WORJ45SS8.005-L-IE-RJ45SS8.005/S3400			8080803	8080804	8080752			

* Unsere Standardleitungslängen sind 2m, 5m oder 10m für Anschlussleitungen und 1m, 2m oder 5m für Verbindungsleitungen. Die Litzenlänge bei Flanschen beträgt 0,5m (POWER 0,2m). Alle anderen Leitungs- und Litzenlängen liefern wir Ihnen gern auf Anfrage.

				L = Leitungslänge								
		Farbe	UL	Artikelbezeichnung	0,3m	0,5m	1m	2m	5m	7,5m	10m	12,5m
	Verbindungsleitung Cat5e Stecker, RJ45, gewinkelt, 90° Stecker, RJ45, axial Industrial	GN		IE-W3RJ45SS8.005-L-IE-RJ45SS8.005/S3400			8080805	8080806	8080753			
	Verbindungsleitung Cat5e Stecker, RJ45, gewinkelt, 180° Stecker, RJ45, axial Industrial	GN		IE-W6RJ45SS8.005-L-IE-RJ45SS8.005/S3400			8080807	8080995	8080754			
	Verbindungsleitung Cat5e Stecker, RJ45, gewinkelt, 270° Stecker, RJ45, axial Industrial	GN		IE-W9RJ45SS8.005-L-IE-RJ45SS8.005/S3400			8080808	8080997	8080755			

RJ45 Patchcords

* Unsere Standardleitungslängen sind 2m, 5m oder 10m für Anschlussleitungen und 1m, 2m oder 5m für Verbindungsleitungen. Die Litzenlänge bei Flanschen beträgt 0,5m (POWER 0,2m). Alle anderen Leitungs- und Litzenlängen liefern wir Ihnen gern auf Anfrage.



Nomenklatur

PB-	W	WAK	S	W	2.012-	L	Verbindungsleitung						16	/S1800	/S3525
							- PB-	W	WAS	S	W	2.012			
			geschirmt	B-codiert	Polzahl.Anschlussbelegung	L: Leitungslänge, Litzenlänge [m] P: Printkontakt bei Flanschen	Profibus	W: gewinkelt ohne: axial	WAS: M12x1 Stecker	geschirmt	B-codiert	Polzahl.Anschlussbelegung		Leitungsqualität	Extra: z.B Wanddickenausgleich oder farbiger Kontaktträger
		WAK: M12x1 Kupplung WAS: M12x1 Stecker FK: M12x1 Flanschkupplung Vorderwandmontage FKF(D): M12x1 Flanschkupplung Hinterwandmontage (drehbare Befestigungsschraube)													
	W: gewinkelt ohne: axial														
Profibus															

Profibus



Leitung **Kurzbeschreibung**

S1800 | PUR Flexible PUR/PE Datenleitung PROFIBUS für mittlere Beanspruchungen. Halogenfrei, flammwidrig, gute Schleppkettentauglichkeit. Gute Öl- und Chemikalienbeständigkeit, mit UL Style.

Abschlussstecker **T-Verteiler geschirmt** **Y-Verteiler geschirmt**











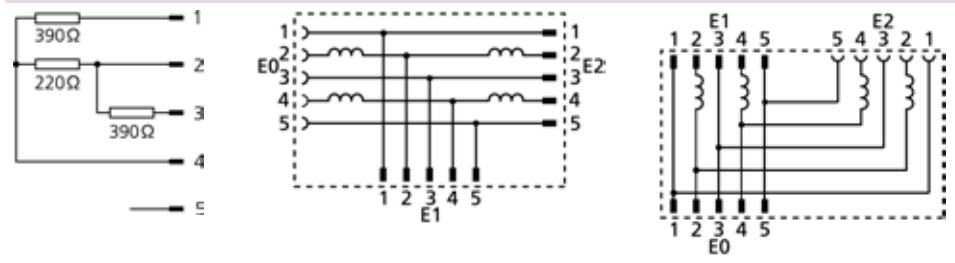





Abbildung im Maßstab ~ 1:1









Profibus

Technische Daten	Steckverbinder + Abschlussstück	Flansch	T-, Y-Verteiler	Selbstkonfektionierbar
Isolationswiderstand	$\geq 10^8 \Omega$	$\geq 10^8 \Omega$	$\geq 10^8 \Omega$	$\geq 10^8 \Omega$
Durchgangswiderstand	$\leq 5 m\Omega$	$\leq 5 m\Omega$	$\leq 5 m\Omega$	$\leq 5 m\Omega$
Umgebungstemperatur	-30°C...+90°C	-30°C...+90°C (* +70°C)	-30°C...+90°C	-40°C...+85°C
Material Kontakte	Metall, CuZn, vergoldet	Metall, vergoldet	Metall, vergoldet	Metall, vergoldet
Material Kontaktträger	Kunststoff, TPU, BK	Kunststoff, TPU, VT	Kunststoff, TPU	Kunststoff, PA
Material Griffkörper	Kunststoff, TPU, BK	Kunststoff, TPU	Kunststoff, TPU	Zinkdruckguss, vernickelt
Material Überwurf	Metall, CuZn, vernickelt			Metall, vernickelt
Material Dichtung (Kupplung)	FPM/FKM	FPM/FKM	FPM/FKM	FPM/FKM
Material äußere Dichtung		NBR		
Material Flanschgehäuse		Metall, CuZn, vernickelt		
Normen	IEC 61076-2-101	IEC 61076-2-101	IEC 61076-2-101/-104	IEC 61076-2-101
Schutzart (montiert)	IP65, IP67, IP68	IP65, IP67, IP68	IP65, IP67, IP68	IP67
Mechanische Lebensdauer	>100 Steckzyklen	>100 Steckzyklen	>100 Steckzyklen	>100 Steckzyklen
Verschmutzungsgrad	3	3	3	3
Anschlussquerschnitt				max. 0,75mm ²
Anschlussart				Schraub-/Klemmanschluss









Die in der Feldbustechnik eingesetzten Steckverbinder müssen buspezifische Anforderungen erfüllen. Wir haben ein Produktprogramm entwickelt, das die Anforderungen der PROFIBUS/PROFINET-Nutzerorganisation (PNO) erfüllt: 5-polig, B-codierte Steckverbinder, Flansche, T-Verteiler und Y-Verteiler mit 360°-Schirmung.

		Kopf				Leitung			Artikelbezeichnung	L = Leitungslänge*		
		Pol	U[max]	I[max]	Δh[mm]	Material	Farbe	UL		2m / 1m	5m / 2m	10m / 5m
	Anschlussleitung Kupplung, M12x1, axial geschirmt	5, B	60V	4A		PUR	VT	•	PB-WAKSW2.012-L/S1800	8043866	8043868	8043869
	Anschlussleitung Kupplung, M12x1, gewinkelt geschirmt	5, B	60V	4A		PUR	VT	•	PB-WWAKSW2.012-L/S1800	8043870	8043871	8043872
	Anschlussleitung Stecker, M12x1, axial geschirmt	5, B	60V	4A		PUR	VT	•	PB-WASSW2.012-L/S1800	8043873	8043874	8043875
	Anschlussleitung Stecker, M12x1, gewinkelt geschirmt	5, B	60V	4A		PUR	VT	•	PB-WWASSW2.012-L/S1800	8043876	8043877	8043878
	Flansch Anschlussleitung Kupplung, M12x1, axial geschirmt Leitung Vorderwandmontage	5, B	60V	4A		PUR	VT	•	PB-FKSW2.012-L/16/S1800/S3941	8063621	8063622	8063623
	Flansch Anschlussleitung Kupplung, M12x1, axial geschirmt Leitung Hinterwandmontage	5, B	60V	4A		PUR	VT	•	PB-FKFDSW2.012-L/16/S1800	8061882	8063617	8063618
	Flansch Anschlussleitung Kupplung, M12x1, gewinkelt geschirmt Leitung Hinterwandmontage	5, B	60V	4A		PUR	VT	•	PB-WFKFDSW2.012-L/16/S1800	8061881	8063619	8063620
	Flansch Kupplung, M12x1, gewinkelt geschirmt Printanschluss Hinterwandmontage	5, B	60V	4A	1,0...2,5				PB-WFKFSW5-P/12/S3525	8050279		
				4A	2,5...4,0				PB-WFKFSW5-P/12/S3540	8050280		
				4A	4,0...5,0				PB-WFKFSW5-P/12/S3550	8050281		
	Flansch Kupplung, M12x1, axial Litzenanschluss Hinterwandmontage	5, B	60V	4A					PB-FHM12KUB2.012-0,5/M16	8072599		
	Flansch Kupplung, M12x1, axial Printanschluss Hinterwandmontage	5, B	60V	4A					PB-FHM12KUB5-P/M16	8072611		
	Flansch Stecker, M12x1, axial Litzenanschluss Hinterwandmontage	5, B	60V	4A					PB-FHM12SUB2.012-0,5/M16	8072633		

* Unsere Standardleitungslängen sind 2m, 5m oder 10m für Anschlussleitungen und 1m, 2m oder 5m für Verbindungsleitungen. Die Litzenlänge bei Flanschen beträgt 0,5m (POWER 0,2m). Alle anderen Leitungs- und Litzenlängen liefern wir Ihnen gern auf Anfrage.

		Kopf				Leitung			Artikelbezeichnung	L = Leitungslänge*		
		Pol	U[max]	I[max]	Δh[mm]	Material	Farbe	UL		2m / 1m	5m / 2m	10m / 5m
	Flansch Stecker, M12x1, axial Printanschluss Hinterwandmontage	5, B	60V	4A					PB-FHM12SUB5-P/M16	8072640		
	Flansch Kupplung, M12x1, axial Litzenanschluss Vorderwandmontage	5, B	60V	4A					PB-FVM12KUB2.012-0,5/M16	8072602		
	Flansch Stecker, M12x1, axial Litzenanschluss Vorderwandmontage	5, B	60V	4A					PB-FVM12SUB2.012-0,5/M16	8072634		
	Flansch Stecker, M12x1, gewinkelt geschirmt Printanschluss Hinterwandmontage	5, B	60V	4A					PB-WFSFSW5-P/12	8045658		
	Flansch Kupplung, M12x1, axial Litzenanschluss Vorderwandmontage, positionierbar	5, B	60V	4A					PB-FVM12KUB2.012-0,5/M16/S520	8077910		
	Flansch Stecker, M12x1, axial Litzenanschluss Vorderwandmontage, positionierbar	5, B	60V	4A					PB-FVM12SUB2.012-0,5/M16/S520	8077971		
	Verbindungsleitung Kupplung, M12x1, axial geschirmt	5, B 5, B	60V	4A		PUR	VT	•	PB-WAKSW2.012-L-PB-WASSW2.012/S1800	8045613	8043867	8043879
	Verbindungsleitung Kupplung, M12x1, axial Stecker, M12x1, gewinkelt geschirmt	5, B 5, B	60V	4A		PUR	VT	•	PB-WAKSW2.012-L-PB-WWASSW2.012/S1800	8051935	8043884	8043885
	Verbindungsleitung Kupplung, M12x1, gewinkelt Stecker, M12x1, axial geschirmt	5, B 5, B	60V	4A		PUR	VT	•	PB-WWAKSW2.012-L-PB-WASSW2.012/S1800	8046479	8043881	8043882

* Unsere Standardleitungslängen sind 2m, 5m oder 10m für Anschlussleitungen und 1m, 2m oder 5m für Verbindungsleitungen. Die Litzenlänge bei Flanschen beträgt 0,5m (POWER 0,2m). Alle anderen Leitungs- und Litzenlängen liefern wir Ihnen gern auf Anfrage.

		Kopf				Leitung			Artikelbezeichnung	L = Leitungslänge*		
		Pol	U[max]	I[max]	Δh[mm]	Material	Farbe	UL		2m / 1m	5m / 2m	10m / 5m
	Verbindungsleitung Kupplung, M12x1, gewinkelt Stecker, M12x1, gewinkelt geschirmt	5, B 5, B	60V	4A		PUR	VT	•	PB-WWAKSW2.012-L-PB-WWASSW2.012/S1800	8051936	8043887	8043888
	Steckverbinder selbstkonfektionierbar Kupplung, M12x1, axial geschirmt Schraub-/Klemmanschluss	5, B	125V	4A					PB-WAKCSW4.5K	8031376		
	Steckverbinder selbstkonfektionierbar Kupplung, M12x1, gewinkelt geschirmt Schraub-/Klemmanschluss	5, B	125V	4A					PB-WWAKCSW4.5K	8040235		
	Steckverbinder selbstkonfektionierbar Stecker, M12x1, axial geschirmt Schraub-/Klemmanschluss	5, B	125V	4A					PB-WASCSW4.5K	8031375		
	Steckverbinder selbstkonfektionierbar Stecker, M12x1, gewinkelt geschirmt Schraub-/Klemmanschluss	5, B	125V	4A					PB-WWASCSW4.5K	8040236		
	Abschlussstück Stecker, M12x1, axial	5, B	60V	4A				•	PB-WASSW4.5-AS	8043520		
	T-Verteiler geschirmt	5 5	60V	0,4A					PB-T-WAKSW5-WASSW5-WASSW5	8057719		
	Y-Verteiler geschirmt	5 5	60V	0,4A					PB-Y-WASSW5-WASSW5-WAKSW5	8057724		

* Unsere Standardleitungslängen sind 2m, 5m oder 10m für Anschlussleitungen und 1m, 2m oder 5m für Verbindungsleitungen. Die Litzenlänge bei Flanschen beträgt 0,5m (POWER 0,2m). Alle anderen Leitungs- und Litzenlängen liefern wir Ihnen gern auf Anfrage.

Nomenklatur

CD-	W	WAK	C	5.022-	L	- CD -	W	WAS	5.022	16	/S2800
-----	---	-----	---	--------	---	--------	---	-----	-------	----	--------

Verbindungsleitung

Leitungsqualität

Befestigungsgewinde bei Flanschen M16x1,5

Polzahl.Anschlussbelegung

WAS: M12x1 Stecker

W: gewinkelt | ohne: axial

CANopen/DeviceNet

L: Leitungslänge [m] | K: Schraub-/Klemmanschluss bei selbstkonfektionierbaren Steckverbindern

Polzahl.Anschlussbelegung

selbstkonfektionierbar

WAK: M12x1 Kupplung | WAS: M12x1 Stecker | FK: M12x1 Flanschkupplung Vorderwandmontage | FKF(D): M12x1 Flanschkupplung Hinterwandmontage (drehbare Befestigungsschraube)

W: gewinkelt | ohne: axial

CANopen/DeviceNet



Leitung	Kurzbeschreibung
---------	------------------

S2800 PUR	Flexible PUR/PE,PP Datenleitung CAN/DeviceNet für mittlere Beanspruchungen. Halogenfrei, flammwidrig. Gute Öl- und Chemikalienbeständigkeit, mit UL Style.
-------------	--

Abschlusskupplung	Abschlussstecker	T-Verteiler geschirmt
-------------------	------------------	-----------------------





Abbildung im Maßstab ~ 1:1





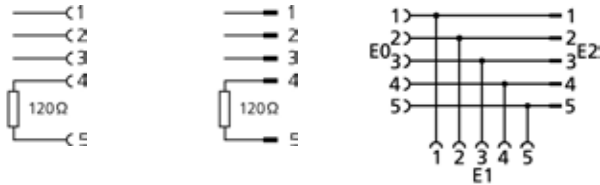

CANopen/DeviceNet

Technische Daten	Steckverbinder + Abschlussstück	Flansch	T-Verteiler	Selbstkonfektionierbar
Isolationswiderstand	$\geq 10^8 \Omega$	$\geq 10^8 \Omega$	$\geq 10^8 \Omega$	$\geq 10^8 \Omega$
Umgebungstemperatur	-30°C...+90°C	-30°C...+90°C	-30°C...+90°C	-40°C...+85°C
Material Kontakte	Metall, CuZn, vergoldet	Metall, vergoldet	Metall, vergoldet	Metall, CuZn, CuSnZn
Material Kontaktträger	Kunststoff, TPU, BK	Kunststoff, TPU, BK	Kunststoff, TPU	Kunststoff, PA, BK
Material Griffkörper	Kunststoff, TPU, BK		Kunststoff, TPU	Kunststoff, PA, BK
Material Überwurf	Metall, CuZn, vernickelt		Metall, CuZn, vernickelt	Metall, vernickelt
Material Dichtung (Kupplung)	FPM/FKM	FPM/FKM	FPM/FKM	
Material äußere Dichtung		NBR		
Material Flanschgehäuse		Metall, CuZn, vernickelt		
Normen	IEC 61076-2-101	IEC 61076-2-101	IEC 61076-2-101	IEC 61076-2-101
Schutzart (montiert)	IP65, IP67, IP68	IP65, IP67, IP68	IP65, IP67, IP68	IP67
Mechanische Lebensdauer	>100 Steckzyklen	>100 Steckzyklen	>100 Steckzyklen	>100 Steckzyklen
Verschmutzungsgrad	3	3	3	3
Kabeldurchlass				4...6mm
Anschlussquerschnitt				max. 0,75 mm ²

5-polige M12x1-Steckverbinder und Flansche mit geschirmter Leitung in PUR halogenfrei, Twisted-pair für Signale und Versorgungsspannung und separatem Beilauf. So lauten die Anforderungen der ODVA Nutzerorganisation, die unsere Komponenten mit UL-zugelassenem ‚Thin-cable‘ natürlich erfüllen. Darüber hinaus bieten wir M12x1-Abschlussstecker und -kupplungen mit 120Ω Widerstand.

		Kopf				Leitung			Artikelbezeichnung	L = Leitungslänge*		
		Pol	U[max]	I[max]	Extra	Material	Farbe	UL		2m / 1m	5m / 2m	10m / 5m
	Anschlussleitung Kupplung, M12x1, axial	5, A	60V	4A		PUR	BK	•	CD-WAK5.022-L/S2800	8047517	8047518	8047519
	Anschlussleitung Kupplung, M12x1, gewinkelt	5, A	60V	4A		PUR	BK	•	CD-WWAK5.022-L/S2800	8047520	8047521	8047522
	Steckverbinder selbstkonfektionierbar Kupplung, M12x1, axial Schraub-/Klemmanschluss	5, A	125V	4A					WAKC5K	8004815		
	Steckverbinder selbstkonfektionierbar Kupplung, M12x1, gewinkelt Schraub-/Klemmanschluss	5, A	125V	4A					WWAKC5K	8004809		
	Flansch Kupplung, M12x1, axial Litzenanschluss Vorderwandmontage	5, A	60V	4A					CD-FK5.022-0,5/16	8047958		
	Flansch Kupplung, M12x1, axial Litzenanschluss Hinterwandmontage	5, A	60V	4A					CD-FKFD5.022-0,5/16	8047961		
	Anschlussleitung Stecker, M12x1, axial	5, A	60V	4A		PUR	BK	•	CD-WAS5.022-L/S2800	8047523	8047524	8047525
	Anschlussleitung Stecker, M12x1, gewinkelt	5, A	60V	4A		PUR	BK	•	CD-WWAS5.022-L/S2800	8047526	8047527	8047528
	Steckverbinder selbstkonfektionierbar Stecker, M12x1, axial Schraub-/Klemmanschluss	5, A	125V	4A					WASC5K	8004805		
	Steckverbinder selbstkonfektionierbar Stecker, M12x1, gewinkelt Schraub-/Klemmanschluss	5, A	125V	4A					WWASC5K	8004807		
	Flansch Stecker, M12x1, axial Litzenanschluss Vorderwandmontage	5, A	60V	4A					CD-FS5.022-0,5/16	8047960		
	Flansch Stecker, M12x1, axial Litzenanschluss Hinterwandmontage	5, A	60V	4A					CD-FSFD5.022-0,5/16	8047962		

* Unsere Standardleitungslängen sind 2m, 5m oder 10m für Anschlussleitungen und 1m, 2m oder 5m für Verbindungsleitungen. Die Litzenlänge bei Flanschen beträgt 0,5m (POWER 0,2m). Alle anderen Leitungs- und Litzenlängen liefern wir Ihnen gern auf Anfrage.

		Kopf				Leitung			UL	Artikelbezeichnung	L = Leitungslänge*		
		Pol	U[max]	I[max]	Extra	Material	Farbe	2m / 1m			5m / 2m	10m / 5m	
	Verbindungsleitung Kupplung, M12x1, axial Stecker, M12x1, axial	5, A	60V	4A		PUR	BK	•	CD-WAK5.022-L-CD-WAS5.022/S2800	8047491	8047492	8047494	
	Verbindungsleitung Kupplung, M12x1, axial Stecker, M12x1, gewinkelt	5, A	60V	4A		PUR	BK	•	CD-WAK5.022-L-CD-WWAS5.022/S2800	8051938	8047532	8047533	
	Verbindungsleitung Kupplung, M12x1, gewinkelt Stecker, M12x1, axial	5, A	60V	4A		PUR	BK	•	CD-WWAK5.022-L-CD-WAS5.022/S2800	8051937	8047529	8047530	
	Verbindungsleitung Kupplung, M12x1, gewinkelt Stecker, M12x1, gewinkelt	5, A	60V	4A		PUR	BK	•	CD-WWAK5.022-L-CD-WWAS5.022/S2800	8051939	8047535	8047536	
	Abschlussstück Kupplung, M12x1, axial	5, A	60V	4A				•	CD-WAK2.010-AK/S3234	8047942			
	Abschlussstück Stecker, M12x1, axial	5, A	60V	4A				•	CD-WAS2.010-AS/S3234	8047943			
	T-Verteiler	5, A	60V	4A					FKM5-FKM5-FSM5/S222	8035172			

* Unsere Standardleitungslängen sind 2m, 5m oder 10m für Anschlussleitungen und 1m, 2m oder 5m für Verbindungsleitungen. Die Litzenlänge bei Flanschen beträgt 0,5m (POWER 0,2m). Alle anderen Leitungs- und Litzenlängen liefern wir Ihnen gern auf Anfrage.

Nomenklatur Steckverbinder konfektioniert, Flansche

Verbindungsleitung

Nomenklatur POWER Verteiler

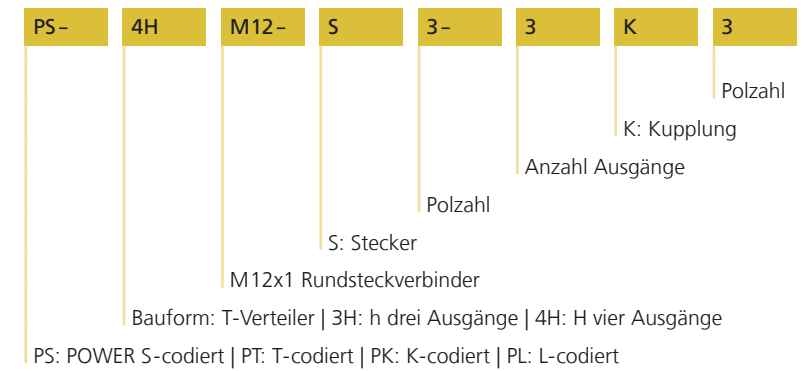
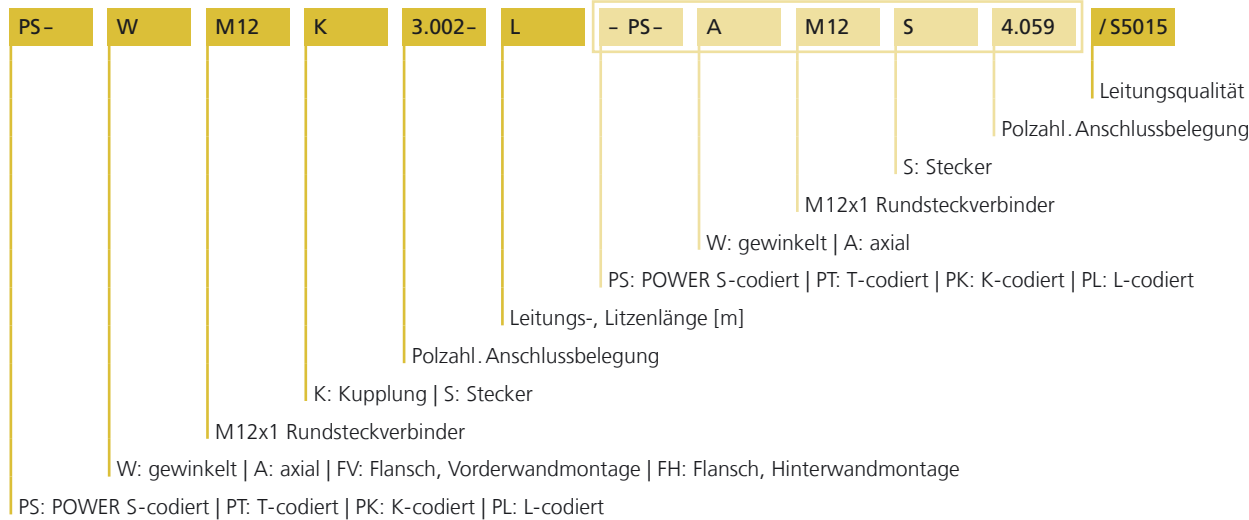

Leitung Kurzbeschreibung

S5015 PUR	Flexible PUR/PP Powerleitung für starke mechanische Beanspruchungen. Halogenfrei, flammwidrig, sehr gute Schleppkettentauglichkeit, öl- und chemikalienbeständig, mit UL-Style. Aderquerschnitt 1,5mm².
S5025 PUR	Flexible PUR/PP Powerleitung für starke mechanische Beanspruchungen. Halogenfrei, flammwidrig, sehr gute Schleppkettentauglichkeit, öl- und chemikalienbeständig, mit UL-Style. Aderquerschnitt 2,5mm².

PK_PL_T PK_PL_3h PK_PL_4H PS_PT_T PS_PT_3h PS_PT_4H











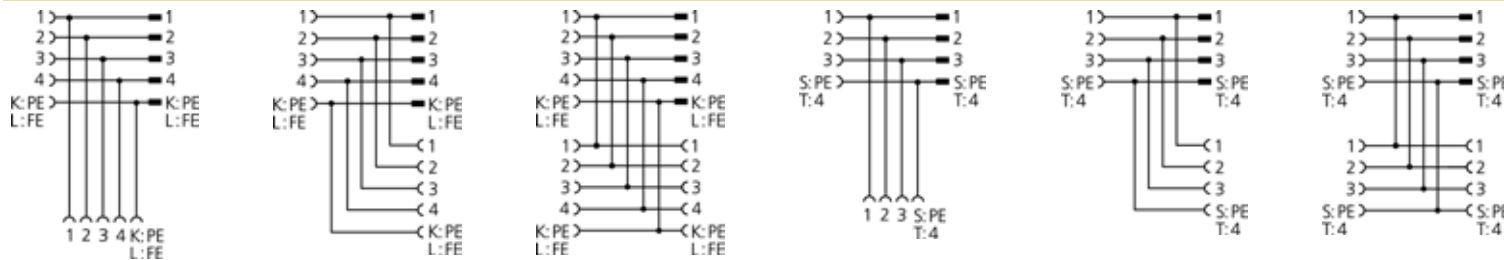



Abbildung im Maßstab ~ 1:1

M12x1 POWER











Technische Daten	Steckverbinder	Flansche	Selbstkonfektionierbar	T-, h-, H-Verteiler
Isolationswiderstand	$\geq 10^8 \Omega$	$\geq 10^8 \Omega$	$\geq 10^8 \Omega$	$\geq 10^8 \Omega$
Durchgangswiderstand	$\leq 5 m\Omega$	$\leq 5 m\Omega$	$\leq 3 m\Omega$	$\leq 5 m\Omega$
Umgebungstemperatur	-30°C...+90°C	-40°C...+85°C	-40°C...+85°C	-30°C...+90°C
Material Kontakte	Metall, CuZn, vergoldet	Metall, vergoldet	Metall, vergoldet	Metall, vergoldet
Material Kontaktträger	Kunststoff, PA, BK	Kunststoff, PA	Kunststoff, PA	Kunststoff, PA, BK
Material Griffkörper	Kunststoff, TPU, BK	Kunststoff, TPU	Kunststoff, PA	Kunststoff, TPU
Material Überwurf	Metall, CuZn, vernickelt	Metall, vernickelt		Metall, vernickelt
Material Dichtung (Kupplung)	FPM/FKM			
Material Flanschgehäuse	Zinkdruckguss vernickelt			
Normen	IEC 61076-2-111		IEC 61076-2-111	IEC 61076-2-101
Schutzart (montiert)	IP65, IP67, IP68	IP65, IP67, IP68	IP67	IP65, IP67, IP68
Mechanische Lebensdauer	>100 Steckzyklen	>100 Steckzyklen	>100 Steckzyklen	>100 Steckzyklen
Verschmutzungsgrad	2	3	3	2
Kabeldurchlass			8...10mm	
Anschlussquerschnitt			1,50mm ²	

M12x1 POWER von ESCHA steht für eine zuverlässige Leistungsübertragung über die genormte M12x1-Schnittstelle. Produkte mit S-Codierung (630V, 12A), T-Codierung (63V, 12A), L-Codierung (63V, 16A, 4-polige Ausführung ohne FE konform zur PNO Guideline) und K-Codierung (630V, 12A, 4+PE) eignen sich aufgrund ihrer kompakten Bauform insbesondere für die Stromversorgung im Automatisierungsbereich. Ein umfangreiches Produktprogramm mit Anschluss- und Verbindungsleitungen sowie H-, h- und T-Verteilern ermöglicht eine serielle Verkabelungsstruktur in der Feldebene. Ein Alleinstellungsmerkmal der gesamten M12x1 POWER Familie ist ihr Anschlussquerschnitt bis 2,5mm². Dieser gestattet im Gegensatz zu kleinen Querschnitten eine große Ausdehnung der Powerverteilung und – insbesondere bei Gleichspannungsverteilung – einen geringeren Spannungsabfall.









		Kopf				Leitung		Artikelbezeichnung	L = Leitungslänge*		
		Pol	U[max]	I[max]	Cod.	Material	Farbe		2m / 1m	5m / 2m	10m / 5m
	Anschlussleitung Kupplung, M12x1, axial	2+PE	630V _{AC} 600V _{AC} (UL)	12A	S	PUR	BK	PS-AM12K3.002-L/S5015	8064011	8064012	8064013
		3+PE	630V _{AC} 600V _{AC} (UL)	12A	S	PUR	BK	PS-AM12K4.155-L/S5015	8068091	8068092	8068093
	Anschlussleitung Kupplung, M12x1, gewinkelt	2+PE	630V _{AC} 600V _{AC} (UL)	12A	S	PUR	BK	PS-WM12K3.002-L/S5015	8064014	8064015	8064016
		3+PE	630V _{AC} 600V _{AC} (UL)	12A	S	PUR	BK	PS-WM12K4.155-L/S5015	8068095	8068096	8068097
	Anschlussleitung Stecker, M12x1, axial	2+PE	630V _{AC} 600V _{AC} (UL)	12A	S	PUR	BK	PS-AM12S3.002-L/S5015	8064017	8064018	8064019
		3+PE	630V _{AC} 600V _{AC} (UL)	12A	S	PUR	BK	PS-AM12S4.155-L/S5015	8068098	8068106	8068107
	Anschlussleitung Stecker, M12x1, gewinkelt	2+PE	630V _{AC} 600V _{AC} (UL)	12A	S	PUR	BK	PS-WM12S3.002-L/S5015	8064020	8064021	8064022
		3+PE	630V _{AC} 600V _{AC} (UL)	12A	S	PUR	BK	PS-WM12S4.155-L/S5015	8068108	8068109	8068110
	Verbindungsleitung Kupplung, M12x1, axial	2+PE	630V _{AC} 600V _{AC} (UL)	12A	S	PUR	BK	PS-AM12K3.002-L-PS-AM12S3.002/S5015	8063999	8064000	8064001
		3+PE	630V _{AC} 600V _{AC} (UL)	12A	S	PUR	BK	PS-AM12K4.155-L-PS-AM12S4.155/S5015	8068297	8068131	8068132
	Verbindungsleitung Kupplung, M12x1, axial	2+PE	630V _{AC} 600V _{AC} (UL)	12A	S	PUR	BK	PS-AM12K3.002-L-PS-WM12S3.002/S5015	8064002	8064003	8064004
		3+PE	630V _{AC} 600V _{AC} (UL)	12A	S	PUR	BK	PS-AM12K4.155-L-PS-WM12S4.155/S5015	8068298	8068134	8068135
	Verbindungsleitung Kupplung, M12x1, gewinkelt	2+PE	630V _{AC} 600V _{AC} (UL)	12A	S	PUR	BK	PS-WM12K3.002-L-PS-AM12S3.002/S5015	8064008	8064009	8064010
		3+PE	630V _{AC} 600V _{AC} (UL)	12A	S	PUR	BK	PS-WM12K4.155-L-PS-AM12S4.155/S5015	8068301	8068140	8068141
	Verbindungsleitung Kupplung, M12x1, gewinkelt	2+PE	630V _{AC} 600V _{AC} (UL)	12A	S	PUR	BK	PS-WM12K3.002-L-PS-WM12S3.002/S5015	8064005	8064006	8064007
		3+PE	630V _{AC} 600V _{AC} (UL)	12A	S	PUR	BK	PS-WM12K4.155-L-PS-WM12S4.155/S5015	8068299	8068137	8068138
	Flansch Kupplung, M12x1, axial	2+PE	630V	16A	S			PS-FVM12K3.031-0,2	8064859		
		3+PE	630V	12A	S			PS-FVM12K4.165-0,2	8067075		
	Litzenanschluss Vorderwandmontage										

M12x1 POWER

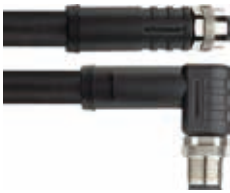









* Unsere Standardleitungslängen sind 2m, 5m oder 10m für Anschlussleitungen und 1m, 2m oder 5m für Verbindungsleitungen. Die Litzenlänge bei Flanschen beträgt 0,5m (POWER 0,2m). Alle anderen Leitungs- und Litzenlängen liefern wir Ihnen gern auf Anfrage.

		Kopf				Leitung		Artikelbezeichnung	L = Leitungslänge*		
		Pol	U[max]	I[max]	Cod.	Material	Farbe		2m / 1m	5m / 2m	10m / 5m
	Flansch Kupplung, M12x1, axial Litzenanschluss Hinterwandmontage	2+PE	630V	16A	S			PS-FHM12K3.031-0,2	8064861		
		3+PE	630V	12A	S			PS-FHM12K4.165-0,2	8067077		
	Flansch Stecker, M12x1, axial Litzenanschluss Vorderwandmontage	2+PE	630V	16A	S			PS-FVM12S3.031-0,2	8064858		
		3+PE	630V	12A	S			PS-FVM12S4.165-0,2	8067074		
	Flansch Stecker, M12x1, axial Litzenanschluss Hinterwandmontage	2+PE	630V	16A	S			PS-FHM12S3.031-0,2	8064860		
		3+PE	630V	12A	S			PS-FHM12S4.165-0,2	8067076		
	Steckverbinder selbstkonfektionierbar Kupplung, M12x1, axial Schraub-/Klemmanschluss	3+PE	630V	12A	S			PS-WAKC4K	8063400		
	Steckverbinder selbstkonfektionierbar Stecker, M12x1, axial Schraub-/Klemmanschluss	3+PE	630V	12A	S			PS-WASC4K	8063399		
	T-Verteiler	3+PE	630V _{AC} 600V _{AC} (UL)	12A	S			PS-TM12-S4-2K4	8062858		
	h-Verteiler	3+PE	630V _{AC} 600V _{AC} (UL)	12A	S			PS-3HM12-S4-2K4	8062859		
	H-Verteiler	3+PE	630V _{AC} 600V _{AC} (UL)	12A	S			PS-4HM12-S4-3K4	8062860		
	Anschlussleitung Kupplung, M12x1, axial	4	63V	12A	T	PUR	BK	PT-AM12K4-L/S5015	8063986	8063987	8063988
				12A	T	PUR	BK	PT-AM12K4-L/S5025	8063962	8063963	8063964
	Anschlussleitung Kupplung, M12x1, gewinkelt	4	63V	12A	T	PUR	BK	PT-WM12K4-L/S5015	8063989	8063990	8063991
				12A	T	PUR	BK	PT-WM12K4-L/S5025	8063965	8063966	8063967
	Anschlussleitung Stecker, M12x1, axial	4	63V	12A	T	PUR	BK	PT-AM12S4-L/S5015	8063992	8063993	8063994
				12A	T	PUR	BK	PT-AM12S4-L/S5025	8063968	8063969	8063970









* Unsere Standardleitungslängen sind 2m, 5m oder 10m für Anschlussleitungen und 1m, 2m oder 5m für Verbindungsleitungen. Die Litzenlänge bei Flanschen beträgt 0,5m (POWER 0,2m). Alle anderen Leitungs- und Litzenlängen liefern wir Ihnen gern auf Anfrage.

		Kopf				Leitung		Artikelbezeichnung	L = Leitungslänge*		
		Pol	U[max]	I[max]	Cod.	Material	Farbe		2m / 1m	5m / 2m	10m / 5m
	Anschlussleitung Stecker, M12x1, gewinkelt	4	63V	12A	T	PUR	BK	PT-WM12S4-L/S5015	8063998	8063997	8063995
				12A	T	PUR	BK	PT-WM12S4-L/S5025	8063971	8063972	8063973
	Verbindungsleitung Kupplung, M12x1, axial Stecker, M12x1, axial	4	63V _{DC}	12A	T	PUR	BK	PT-AM12K4-L-PT-AM12S4/S5015	8063974	8063975	8063976
				12A	T	PUR	BK	PT-AM12K4-L-PT-AM12S4/S5025	8063950	8063951	8063952
	Verbindungsleitung Kupplung, M12x1, axial Stecker, M12x1, gewinkelt	4	63V _{DC}	12A	T	PUR	BK	PT-AM12K4-L-PT-WM12S4/S5015	8063977	8063978	8063979
				12A	T	PUR	BK	PT-AM12K4-L-PT-WM12S4/S5025	8063953	8063954	8063955
	Verbindungsleitung Kupplung, M12x1, gewinkelt Stecker, M12x1, axial	4	63V _{DC}	12A	T	PUR	BK	PT-WM12K4-L-PT-AM12S4/S5015	8063983	8063984	8063985
				12A	T	PUR	BK	PT-WM12K4-L-PT-AM12S4/S5025	8063959	8063960	8063961
	Verbindungsleitung Kupplung, M12x1, gewinkelt Stecker, M12x1, gewinkelt	4	63V _{DC}	12A	T	PUR	BK	PT-WM12K4-L-PT-WM12S4/S5015	8063980	8063981	8063982
				12A	T	PUR	BK	PT-WM12K4-L-PT-WM12S4/S5025	8063956	8063957	8063958
	Flansch Kupplung, M12x1, axial Litzenanschluss Vorderwandmontage	4	63V	12A	T			PT-FVM12K4-0,2	8064855		
	Flansch Kupplung, M12x1, axial Litzenanschluss Hinterwandmontage	4	63V	12A	T			PT-FHM12K4-0,2	8064857		
	Flansch Stecker, M12x1, axial Litzenanschluss Vorderwandmontage	4	63V	12A	T			PT-FVM12S4-0,2	8064854		
	Flansch Stecker, M12x1, axial Litzenanschluss Hinterwandmontage	4	63V	12A	T			PT-FHM12S4-0,2	8064856		









* Unsere Standardleitungslängen sind 2m, 5m oder 10m für Anschlussleitungen und 1m, 2m oder 5m für Verbindungsleitungen. Die Litzenlänge bei Flanschen beträgt 0,5m (POWER 0,2m). Alle anderen Leitungs- und Litzenlängen liefern wir Ihnen gern auf Anfrage.

		Kopf				Leitung		Artikelbezeichnung	L = Leitungslänge*		
		Pol	U[max]	I[max]	Cod.	Material	Farbe		2m / 1m	5m / 2m	10m / 5m
	Steckverbinder selbstkonfektionierbar Kupplung, M12x1, axial Schraub-/Klemmanschluss	4	63V	12A	T			PT-WAKC4K	8063398		
	Steckverbinder selbstkonfektionierbar Stecker, M12x1, axial Schraub-/Klemmanschluss	4	63V	12A	T			PT-WASC4K	8063397		
	T-Verteiler	4	63V	12A	T			PT-TM12-S4-2K4	8067897		
	h-Verteiler	4	63V	12A	T			PT-3HM12-S4-2K4	8067900		
	H-Verteiler	4	63V	12A	T			PT-4HM12-S4-3K4	8067903		
	Anschlussleitung Kupplung, M12x1, axial	4+PE	630V _{AC}	12A	K	PUR	BK	PK-AM12K5.244-L/S5015	8075272	8075273	8075274
	Anschlussleitung Kupplung, M12x1, gewinkelt	4+PE	630V _{AC}	12A	K	PUR	BK	PK-WM12K5.244-L/S5015	8075298	8075299	8075300
	Anschlussleitung Stecker, M12x1, axial	4+PE	630V _{AC}	12A	K	PUR	BK	PK-AM12S5.244-L/S5015	8075301	8075302	8075303
	Anschlussleitung Stecker, M12x1, gewinkelt	4+PE	630V _{AC}	12A	K	PUR	BK	PK-WM12S5.244-L/S5015	8075315	8075319	8075322
	Verbindungsleitung Kupplung, M12x1, axial Stecker, M12x1, axial	4+PE	630V _{AC}	12A	K	PUR	BK	PK-AM12K5.244-L-PK-AM12S5.244/S5015	8075847	8075848	8075849

* Unsere Standardleitungslängen sind 2m, 5m oder 10m für Anschlussleitungen und 1m, 2m oder 5m für Verbindungsleitungen. Die Litzenlänge bei Flanschen beträgt 0,5m (POWER 0,2m). Alle anderen Leitungs- und Litzenlängen liefern wir Ihnen gern auf Anfrage.

		Kopf				Leitung		Artikelbezeichnung	L = Leitungslänge*		
		Pol	U[max]	I[max]	Cod.	Material	Farbe		2m / 1m	5m / 2m	10m / 5m
	Verbindungsleitung Kupplung, M12x1, axial Stecker, M12x1, gewinkelt	4+PE	630V _{AC}	12A	K	PUR	BK	PK-AM12K5.244-L-PK-WM12S5.244/S5015	8076185	8076186	8076187
	Verbindungsleitung Kupplung, M12x1, gewinkelt Stecker, M12x1, axial	4+PE	630V _{AC}	12A	K	PUR	BK	PK-WM12K5.244-L-PK-AM12S5.244/S5015	8076204	8076205	8076206
	Verbindungsleitung Kupplung, M12x1, gewinkelt Stecker, M12x1, gewinkelt	4+PE	630V _{AC}	12A	K	PUR	BK	PK-WM12K5.244-L-PK-WM12S5.244/S5015	8076195	8076196	8076197
	T-Verteiler	4+PE	630V _{AC}	12A	K			PK-TM12-S5-2K5	8075810		
	h-Verteiler	4+PE	630V _{AC}	12A	K			PK-3HM12-S5-2K5	8075817		
	H-Verteiler	4+PE	630V _{AC}	12A	K			PK-4HM12-S5-3K5	8075818		
	Anschlussleitung Kupplung, M12x1, axial	4	63V _{DC}	16A	L	PUR	BK	PL-AM12K4-L/S5015	8076483	8076484	8076523
				16A	L	PUR	BK	PL-AM12K4-L/S5025	8076486	8076487	8076524
	Anschlussleitung Kupplung, M12x1, gewinkelt	4	63V _{DC}	16A	L	PUR	BK	PL-WM12K4-L/S5015	8076489	8076490	8076525
				16A	L	PUR	BK	PL-WM12K4-L/S5025	8076492	8076493	8076526

* Unsere Standardleitungslängen sind 2m, 5m oder 10m für Anschlussleitungen und 1m, 2m oder 5m für Verbindungsleitungen. Die Litzenlänge bei Flanschen beträgt 0,5m (POWER 0,2m). Alle anderen Leitungs- und Litzenlängen liefern wir Ihnen gern auf Anfrage.

		Kopf				Leitung		Artikelbezeichnung	L = Leitungslänge*		
		Pol	U[max]	I[max]	Cod.	Material	Farbe		2m / 1m	5m / 2m	10m / 5m
	Anschlussleitung Stecker, M12x1, axial	4	63V _{DC}	16A	L	PUR	BK	PL-AM12S4-L/S5015	8076495	8076496	8076527
				16A	L	PUR	BK	PL-AM12S4-L/S5025	8076498	8076499	8076528
	Anschlussleitung Stecker, M12x1, gewinkelt	4	63V _{DC}	16A	L	PUR	BK	PL-WM12S4-L/S5015	8076501	8076502	8076529
				16A	L	PUR	BK	PL-WM12S4-L/S5025	8076504	8076505	8076530
	Verbindungsleitung Kupplung, M12x1, axial	4	63V _{DC}	16A	L	PUR	BK	PL-AM12K4-L-PL-AM12S4/S5015	8076457	8076458	8076459
				16A	L	PUR	BK	PL-AM12K4-L-PL-AM12S4/S5025	8076460	8076461	8076462
	Verbindungsleitung Kupplung, M12x1, axial Stecker, M12x1, gewinkelt	4	63V _{DC}	16A	L	PUR	BK	PL-AM12K4-L-PL-WM12S4/S5015	8076463	8076464	8076465
				16A	L	PUR	BK	PL-AM12K4-L-PL-WM12S4/S5025	8076466	8076467	8076468
	Verbindungsleitung Kupplung, M12x1, gewinkelt Stecker, M12x1, axial	4	63V _{DC}	16A	L	PUR	BK	PL-WM12K4-L-PL-AM12S4/S5015	8076478	8076476	8076477
				16A	L	PUR	BK	PL-WM12K4-L-PL-AM12S4/S5025	8076479	8076480	8076481
	Verbindungsleitung Kupplung, M12x1, gewinkelt Stecker, M12x1, gewinkelt	4	63V _{DC}	16A	L	PUR	BK	PL-WM12K4-L-PL-WM12S4/S5015	8076469	8076470	8076471
				16A	L	PUR	BK	PL-WM12K4-L-PL-WM12S4/S5025	8076472	8076473	8076475
	T-Verteiler	5	63V _{DC}	16A	L			PL-TM12-S5-2K5	8075819		
	h-Verteiler	5	63V _{DC}	16A	L			PL-3HM12-S5-2K5	8075820		
	H-Verteiler	5	63V _{DC}	16A	L			PL-4HM12-S5-3K5	8075821		

Nomenklatur 2-fach Verteiler mit zwei gleichen Ausgängen



Nomenklatur 2-fach Verteiler mit drei unterschiedlichen Ausgängen

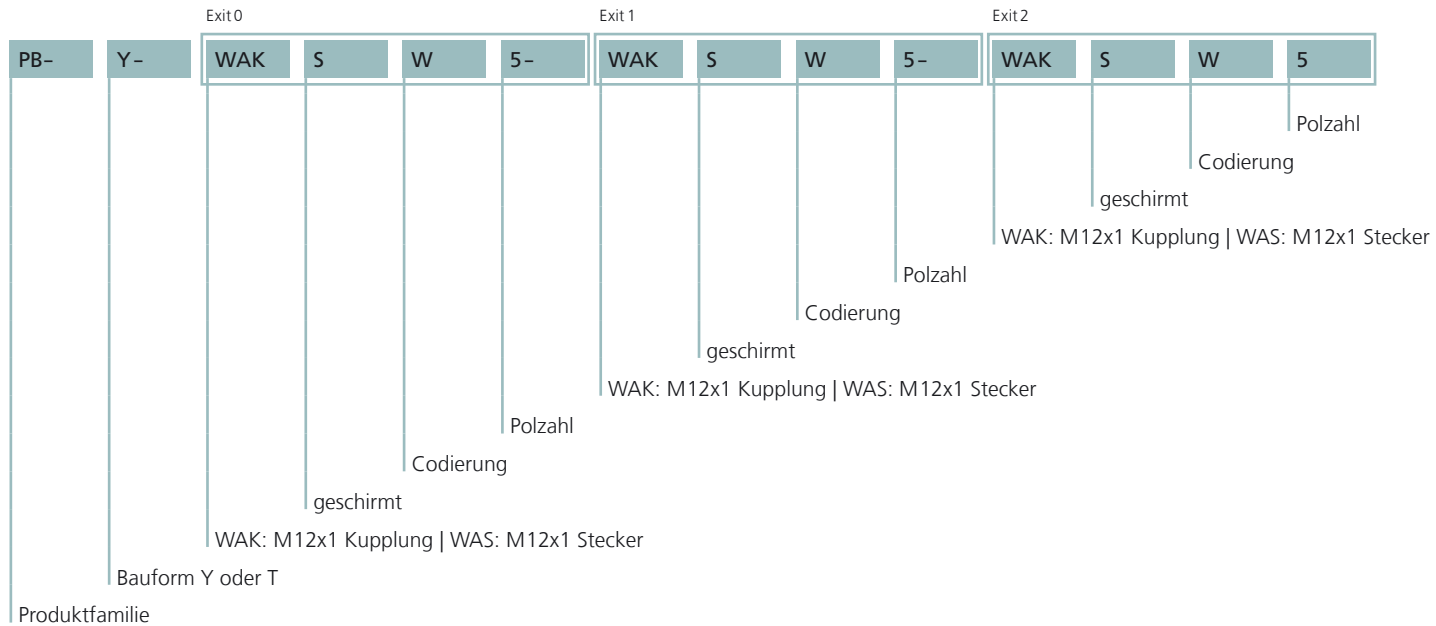



T geschirmt



Y



S89



MB_M12x1



MB_M12x1 geschirmt



S55













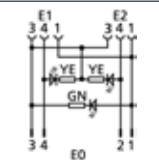

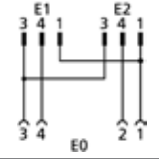

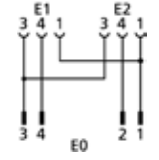
MB_M8x1

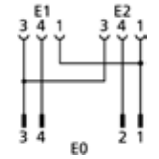

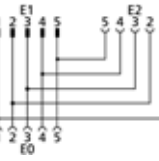

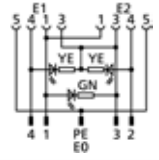

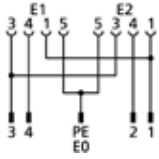

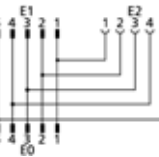

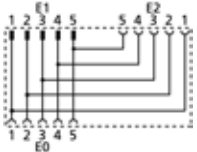

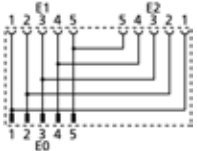

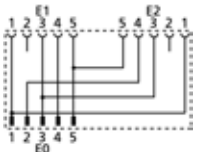
Abbildung im Maßstab ~ 1:1

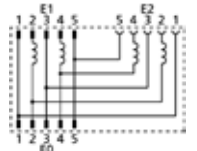

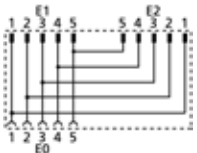

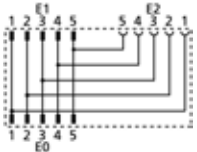

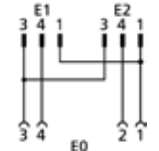

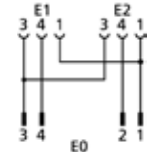

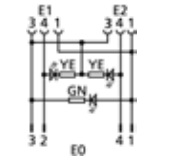
2-fach Verteiler

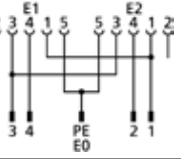

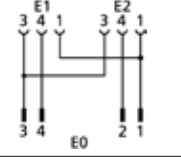

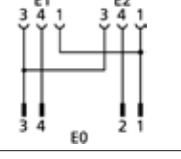
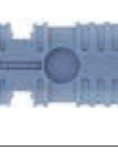
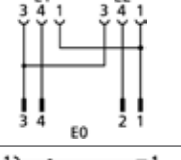

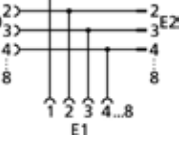

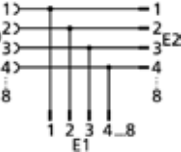

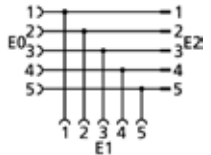

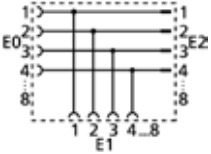

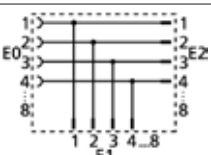
Technische Daten	Y-Verteiler	T-Verteiler	Adapter	Wanddurchführung
Isolationswiderstand	≥10 ⁸ Ω	≥10 ⁸ Ω	≥10 ⁸ Ω	≥10 ⁸ Ω
Umgebungstemperatur	-30°C...+90°C	-30°C...+90°C	-30°C...+90°C	-25°C...+85°C
Material Kontakte	Metall, vergoldet	Metall, vergoldet	Metall	Metall, vergoldet
Material Kontaktträger	Kunststoff, TPU	Kunststoff, TPU	Kunststoff, PA	Kunststoff
Material Griffkörper	Kunststoff, TPU	Kunststoff, TPU	Kunststoff, TPU	
Material Dichtung (Kupplung)	Kunststoff, TPU	FPM/FKM	Kunststoff, TPU	
Normen	IEC 61076-2-101/-104	IEC 61076-2-101		IEC 61076-2-101
Schutzart (montiert)	IP65, IP67, IP68	IP65, IP67, IP68	IP65, IP67, IP68	IP67
Mechanische Lebensdauer	>100 Steckzyklen	>100 Steckzyklen	>100 Steckzyklen	>100 Steckzyklen
Verschmutzungsgrad	3	3	3	3 (RJ45:2)

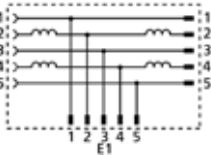

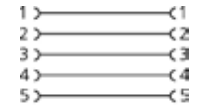

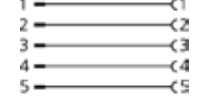

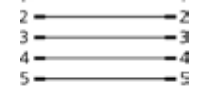



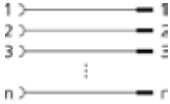

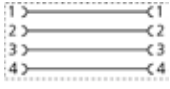
Mit unseren Y- und T-Verteilern können Sie ganz leicht Abzweige realisieren. Denn mit einem 2-fach-Verteiler lassen sich Signale einfach verteilen. Die Anschlüsse (Kupplung oder Stecker) können in diversen Konfigurationen angeordnet werden, wodurch wir Ihnen eine hohe Variabilität und Vielfalt bieten. Auf Wunsch sind auch geschirmte Verteiler für Kommunikationsanwendungen in den Bereichen PROFIBUS und CANopen erhältlich.

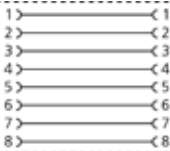

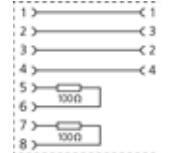

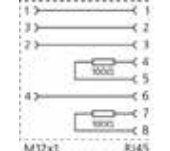

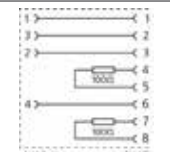

			Ausgang						
			E0	E1	E2	U[max]	I[max]	Artikelbezeichnung	Art.-Nr.
		Y-Verteiler M12x1 S89	Stecker, M12x1, LED 4 Pol, A	Kupplung, M12x1, LED 3 Pol, A	Kupplung, M12x1, LED 3 Pol, A	24V _{dc}	4A	FSM4-2FKM3P3/S89	8012652
		Y-Verteiler M12x1 S89	Kupplung, M12x1 4 Pol, A	Stecker, M12x1 3 Pol, A	Stecker, M12x1 3 Pol, A	250V	4A	FKM4-2FSM3/S89	8012651
		Y-Verteiler M12x1 S89	Stecker, M12x1 4 Pol, A	Kupplung, M12x1 3 Pol, A	Kupplung, M12x1 3 Pol, A	250V	4A	FSM4-2FKM3/S89	8010464
			Stecker, M12x1 5 Pol, A	Kupplung, M12x1 5 Pol, A	Kupplung, M12x1 5 Pol, A	60V	4A	FSM5-2FKM5.4/S89	8010471
		Y-Verteiler M12x1 M8x1 - M8x1 S89	Stecker, M12x1 4 Pol, A	Kupplung, M8x1 3 Pol	Kupplung, M8x1 3 Pol	60V	4A	FSM4-2SKP3/S89	8013058
		Y-Verteiler M12x1 MB	Kupplung, M12x1 5 Pol, A	Stecker, M12x1 5 Pol, A	Kupplung, M12x1 5 Pol, A	60V	4A	MB-FKM5-FSM5-FKM5	8024976
		Y-Verteiler M12x1 MB	Stecker, M12x1, LED 5 Pol, A	Kupplung, M12x1, LED 5 Pol, A	Kupplung, M12x1, LED 5 Pol, A	30V	4A	MB-FSM5-2FKM5.4P3	8024644
		Y-Verteiler M12x1 MB	Stecker, M12x1 5 Pol, A	Kupplung, M12x1 5 Pol, A	Kupplung, M12x1 5 Pol, A	60V	4A	MB-FSM5-2FKM5.4	8024643
			Stecker, M12x1 8 Pol, A	Kupplung, M12x1 8 Pol, A	Kupplung, M12x1 8 Pol, A	60V	2A	MB-FSM8-2FKM8	8028876
		Y-Verteiler M12x1 MB	Stecker, M12x1 5 Pol, A	Stecker, M12x1 5 Pol, A	Kupplung, M12x1 5 Pol, A	60V	4A	MB-FSM5-FSM5-FKM5	8044611

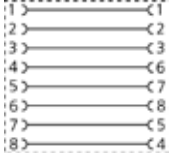
			Ausgang						
			E0	E1	E2	U[max]	I[max]	Artikelbezeichnung	Art.-Nr.
		Y-Verteiler M12x1 geschirmt	Kupplung, M12x1 5 Pol, A	Stecker, M12x1 5 Pol, A	Kupplung, M12x1 5 Pol, A	60V	4A	Y-WAKS5-WASS5-WAKS5	8057723
		Y-Verteiler M12x1 geschirmt	Stecker, M12x1 5 Pol, A	Kupplung, M12x1 5 Pol, A	Kupplung, M12x1 5 Pol, A	60V	4A	Y-WASS5-2WAKS5	8056694
			Stecker, M12x1 8 Pol, A	Kupplung, M12x1 8 Pol, A	Kupplung, M12x1 8 Pol, A	30V	2A	Y-WASS8-2WAKS8	8057725
		Y-Verteiler M12x1 geschirmt	Stecker, M12x1 5 Pol, A	Kupplung, M12x1 5 Pol, A	Kupplung, M12x1 5 Pol, A	60V	4A	Y-WASS5-2WAKS5.4	8062356
		Y-Verteiler PROFIBUS M12x1 geschirmt	Stecker, M12x1 5 Pol, B	Stecker, M12x1 5 Pol, B	Kupplung, M12x1 5 Pol, B	60V	0,4A	PB-Y-WASSW5-WASSW5-WAKSW5	8057724
		Y-Verteiler M12x1 geschirmt	Kupplung, M12x1 5 Pol, A	Stecker, M12x1 5 Pol, A	Stecker, M12x1 5 Pol, A	30V	4A	Y-WAKS5-2WASS5	8057722
		Y-Verteiler M12x1 geschirmt	Stecker, M12x1 5 Pol, A	Stecker, M12x1 5 Pol, A	Kupplung, M12x1 5 Pol, A	60V	4A	Y-WASS5-WASS5-WAKS5	8057721
		Y-Verteiler M12x1 Ø8mm snap - Ø8mm snap	Kupplung, M12x1 4 Pol, A	Stecker, Ø8mm snap 3 Pol	Stecker, Ø8mm snap 3 Pol	60V	4A	FKM4-2ESP3S	8008080
		Y-Verteiler M8x1 MB	Stecker, M8x1 4 Pol	Kupplung, M8x1 3 Pol	Kupplung, M8x1 3 Pol	60V	4A	MB-SSP4-2SKP3/S56	8052222

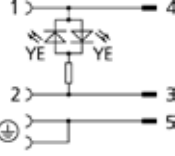
			Ausgang						
			E0	E1	E2	U[max]	I[max]	Artikelbezeichnung	Art.-Nr.
		Y-Verteiler M8x1 MB	Stecker, M8x1, LED 4 Pol	Kupplung, M8x1, LED 3 Pol	Kupplung, M8x1, LED 3 Pol	30V	4A	MB-SSP4-2SKP3P3/S56	8052223
		Y-Verteiler M12x1 S55	Stecker, M12x1 5 Pol, A	Kupplung, M12x1 5 Pol, A	Kupplung, M12x1 5 Pol, A	60V	4A	FSM5-2FKM5.4/S55	8018720
		Y-Verteiler M12x1 M8x1 - M8x1 S55	Stecker, M12x1 4 Pol, A	Kupplung, M8x1 3 Pol	Kupplung, M8x1 3 Pol	60V	4A	FSM4-2SKP3/S55/S56	8052224
		Y-Verteiler M12x1 M8x1 - M8x1	Stecker, M12x1 4 Pol, A	Kupplung, M8x1 3 Pol	Kupplung, M8x1 3 Pol	60V	4A	FSM4-2SKP3	8008081
		Y-Verteiler M8x1/Ø8mm snap M8x1 - M8x1	Stecker, M8x1/ Ø8mm snap 4 Pol	Kupplung, M8x1 3 Pol	Kupplung, M8x1 3 Pol	60V	4A	SESP4S-2SKP3	8008082
		T-Verteiler M12x1	Kupplung, M12x1 4 Pol, A	Kupplung, M12x1 4 Pol, A	Stecker, M12x1 4 Pol, A	250V	4A	FKM4-FKM4-FSM4	8009675
			Kupplung, M12x1 5 Pol, A	Kupplung, M12x1 5 Pol, A	Stecker, M12x1 5 Pol, A	60V	4A	FKM5-FKM5-FSM5	8011661
			Kupplung, M12x1 8 Pol, A	Kupplung, M12x1 8 Pol, A	Stecker, M12x1 8 Pol, A	30V	2A	FKM8-FKM8-FSM8	8038856
		T-Verteiler M12x1	Kupplung, M12x1 4 Pol, A	Stecker, M12x1 4 Pol, A	Stecker, M12x1 4 Pol, A	250V	4A	FKM4-FSM4-FSM4	8008139
			Kupplung, M12x1 5 Pol, A	Stecker, M12x1 5 Pol, A	Stecker, M12x1 5 Pol, A	60V	4A	FKM5-FSM5-FSM5	8017792

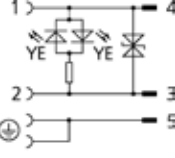
			Ausgang						
			E0	E1	E2	U[max]	I[max]	Artikelbezeichnung	Art.-Nr.
		T-Verteiler CANopen/Devicenet M12x1	Kupplung, M12x1 5 Pol, A	Kupplung, M12x1 5 Pol, A	Stecker, M12x1 5 Pol, A	60V	4A	FKM5-FKM5-FSM5/S222	8035172
		T-Verteiler M12x1 geschirmt	Kupplung, M12x1 5 Pol, A	Kupplung, M12x1 5 Pol, A	Stecker, M12x1 5 Pol, A	60V	4A	T-WAKS5-WAKS5-WASS5	8056693
			Kupplung, M12x1 8 Pol, A	Kupplung, M12x1 8 Pol, A	Stecker, M12x1 8 Pol, A	30V	2A	T-WAKS8-WAKS8-WASS8	8057720
		T-Verteiler M12x1 geschirmt	Kupplung, M12x1 5 Pol, A	Stecker, M12x1 5 Pol, A	Stecker, M12x1 5 Pol, A	60V	4A	T-WAKS5-WASS5-WASS5	8057718
		T-Verteiler PROFIBUS M12x1 geschirmt	Kupplung, M12x1 5 Pol, B	Stecker, M12x1 5 Pol, B	Stecker, M12x1 5 Pol, B	60V	0,4A	PB-T-WAKSW5-WASSW5-WASSW5	8057719
		Adapter M12x1 - M12x1	Kupplung, M12x1 5 Pol, A	Kupplung, M12x1 5 Pol, A		60V	4A	WAK4.5-WAK4.5	8041351
		Adapter M12x1 - M12x1	Kupplung, M12x1 5 Pol, A	Stecker, M12x1 5 Pol, A		60V	4A	WAK4.5-WAS4.5	8041349
		Adapter M12x1 - M12x1	Stecker, M12x1 5 Pol, A	Stecker, M12x1 5 Pol, A		60V	4A	WAS4.5-WAS4.5	8041352
		Adapter M12x1 - M8x1	Stecker, M12x1 3 Pol, A	Kupplung, M8x1 3 Pol		60V	4A	FSM3-SKP3	8008079
			Stecker, M12x1 4 Pol, A	Kupplung, M8x1 4 Pol		60V	4A	FSM4-SKP4	8008138

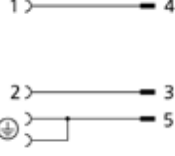
			Ausgang						
			E0	E1	E2	U[max]	I[max]	Artikelbezeichnung	Art.-Nr.
		Wanddurchführung M12x1 - M12x1	Kupplung, M12x1, axial 4 Pol, A	Stecker, M12x1, axial 4 Pol, A		250V	4A	FKFS4/M12	8018404
			Kupplung, M12x1, axial 5 Pol, A	Stecker, M12x1, axial 5 Pol, A		60V	4A	FKFS4.5/M12	8018405
			Kupplung, M12x1, axial 8 Pol, A	Stecker, M12x1, axial 8 Pol, A		30V	2A	FKFS8/M12	8018410
		Adapter Industrial Ethernet M12x1 - M12x1 geschirmt	Kupplung, M12x1, axial 4 Pol, D	Kupplung, M12x1, axial 4 Pol, D		250V	4A	IE-WAKSY4-IE-WAKSY4	8065952
		Adapter Industrial Ethernet M12x1 - M12x1 geschirmt	Kupplung, M12x1, axial 8 Pol, X	Kupplung, M12x1, axial 8 Pol, X		50V _{AC} 60V _{DC}	0,5A	IE-WAKSX8-IE-WAKSX8	8065951
		Adapter Industrial Ethernet M12x1 - M12x1 geschirmt	Kupplung, M12x1, axial 8 Pol, X	Kupplung, M12x1, axial 4 Pol, D		50V _{AC} 60V _{DC}	0,5A	IE-WAKSX8-IE-WAKSY4	8065950
		Wanddurchführung Industrial Ethernet M12x1 - RJ 45 geschirmt	Kupplung, M12x1, axial 4 Pol, D	Kupplung, RJ45, axial 8 Pol		50V _{AC/DC}	0,2A	IE-FKFDSY4-RJ45KS	8069793
		Wanddurchführung Industrial Ethernet M12x1 - RJ 45 geschirmt	Kupplung, M12x1, gewinkelt 4 Pol, D	Kupplung, RJ45, axial 8 Pol		50V _{AC/DC}	0,2A	IE-WFKFDSY4-RJ45KS	8069794
		Wanddurchführung Industrial Ethernet M12x1 - RJ 45 geschirmt	Kupplung, M12x1, axial 8 Pol, X	Kupplung, RJ45, axial 8 Pol		50V _{AC} 60V _{DC}	0,5A	IE-FKFDSX8-RJ45KS	8055773

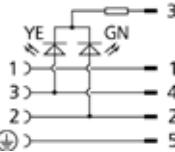
			Ausgang						
			E0	E1	E2	U[max]	I[max]	Artikelbezeichnung	Art.-Nr.
		Wanddurchführung Industrial Ethernet M12x1 - RJ 45 geschirmt	Kupplung, M12x1, gewinkelt 8 Pol, X	Kupplung, RJ45, axial 8 Pol		50V _{AC} 60V _{DC}	0,5A	IE-WFKFDSX8-RJ45KS	8055774
		Adapter Ventil M12x1	Stecker, Ventil A, gewinkelt	M12x1, 5-polig A		24V _{AC/DC}	4A	VA22-24.1-WAS5.002	8055767
		Adapter Ventil M12x1	Stecker, Ventil A, gewinkelt	M12x1, 5-polig A		24V _{AC/DC}	4A	VA22-24.3-WAS5.002	8055768
		Adapter Ventil M12x1	Stecker, Ventil A, gewinkelt	M12x1, 5-polig A		60V _{AC/DC}	4A	VA22-60.0-WAS5.002	8055770
		Adapter Ventil M12x1	Stecker, Ventil A, gewinkelt	M12x1, 5-polig A		24V _{DC}	4A	VA41-24.2-WAS5	8055769

Nomenklatur

Umspritzter Rundsteckverbinder an Ausgang E1 + Ausgang E2

Umspritzter Ventilsteckverbinder an Ausgang E1 + Ausgang E2

YK-	FK	4	M8-	2	AL-	SW	KP	3	P2/	L/	L/	S370
-----	----	---	-----	---	-----	----	----	---	-----	----	----	------

Verteilungssystem mit Kabel

FK: Flansch-Kupplung | FS: Flansch-Stecker

Polzahl Ausgang E0

Bauform Ausgang 0: M8x1 | M12x1

2x folgender Ausgangstyp (Ausgang E1 + Ausgang E2)

Automation Line

M12x1 W: gewinkelt | ohne: gerade
M8x1 SW: schraubbar, gewinkelt | S: schraubbar, gerade

M12x1 WAK: Kupplung | WAS: Stecker
M8x1 KP: Kupplung | SP: Stecker

Polzahl

PNP | Anzahl der LEDs + Beschaltung

Leitungslänge Ausgang E1
Leitungslänge Ausgang E2
Leitungsqualität

2	V	A	22	24.	3
---	---	---	----	-----	---

2x folgender Ausgangstyp (Ausgang E1 + Ausgang E2)

Ventilsteckverbinder

Bauform: A | B | BI | C | CI

Kontakte 21: 2+PE
22: 2+PE gebrückt

$U_{[max]}$: 24Vdc | 24VAc/DC

Beschaltung LED
3: +Transilodiode
4: +Z-Diode



Leitung	Kurzbeschreibung
P00 PVC	Flexible PVC/PVC Sensor-/Aktorsteuerleitung für mittlere mechanische Beanspruchungen. Bedingt öl- und chemikalienbeständig.
S370 PUR	Flexible PUR/PP Sensor-/Aktorsteuerleitung für starke mechanische Beanspruchungen. Halogenfrei, flammwidrig, gute Torsions- und Schleppkettentauglichkeit, öl- und chemikalienbeständig, mit UL-Style.
S7400 PUR	Flexible PUR/PP Sensor-/Aktorsteuerleitung für starke mechanische Beanspruchungen. Halogenfrei, flammwidrig, sehr gute Torsions- und Schleppkettentauglichkeit, öl- und chemikalienbeständig, mit UL-Style.

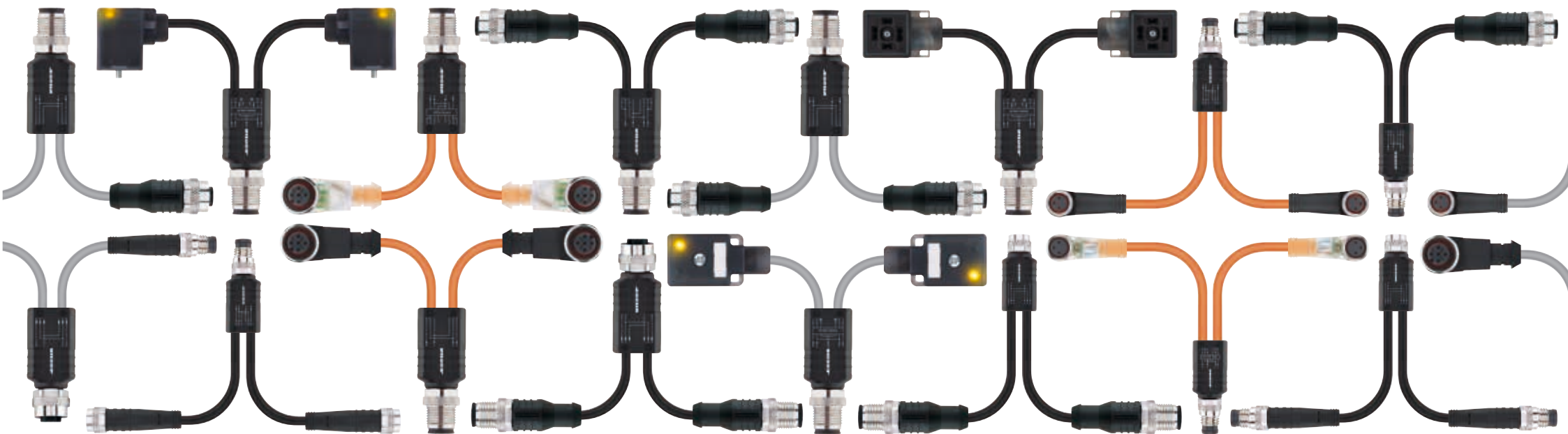









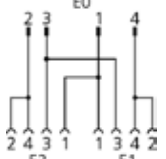

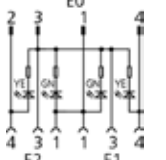

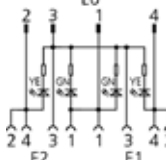

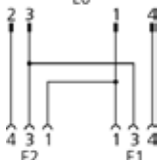

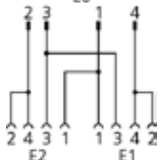

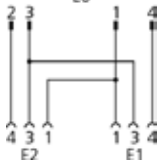

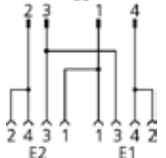



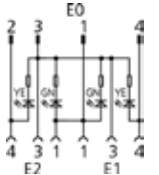

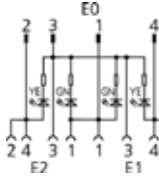
2-fach Verteiler mit Kabelabgang

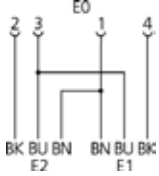
Technische Daten	M12x1	M8x1	Ventil
Isolationswiderstand	$\geq 10^8 \Omega$	$\geq 10^8 \Omega$	$\geq 10^8 \Omega$
Umgebungstemperatur	-30°C...+90°C	-30°C...+90°C	-30°C...+90°C
Material Kontakte	Metall, vergoldet	Metall, vergoldet	Metall, versilbert
Material Kontaktträger	Kunststoff, TPU	Kunststoff, TPU	Kunststoff, PA, BK
Material Griffkörper	Kunststoff, TPU	Kunststoff, TPU	Kunststoff, TPU
Material Überwurf	Metall, vernickelt	Metall, vernickelt	
Material Dichtung (Kupplung)	FPM/FKM	FPM/FKM	Kunststoff, TPU
Normen	IEC 61076-2-101	IEC 61076-2-104	DIN EN 175301-803
Schutzart (montiert)	IP65, IP67, IP68	IP65, IP67, IP68	IP65, IP67, IP68
Mechanische Lebensdauer	>100 Steckzyklen	>100 Steckzyklen	>100 Steckzyklen
Verschmutzungsgrad	3	3	3

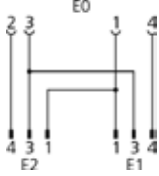

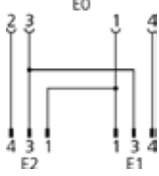

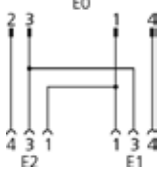

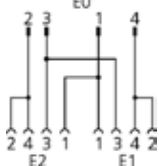



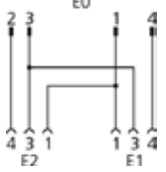

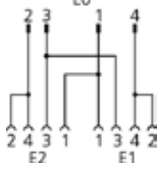
Die äußerst kompakten Y-Verteiler mit Kabelabgang sind in den Bauformen M8x1 und M12x1 erhältlich. Die Anordnung von Stecker oder Kupplung ist frei wählbar. Für die Kabelabgänge stehen alle Standardmeterwaren in PUR und PVC zur Verfügung. Die Kabelabgänge können wunschgemäß mit M8x1-, M12x1- oder Ventilsteckverbindern ausgestattet werden. Durch die unterschiedlichen Optionen ergibt sich eine hohe Variantenvielfalt, die es ermöglicht, für fast jede Applikation das passende Produkt zu konfigurieren.

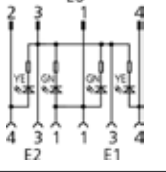

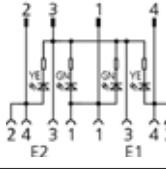
		L = Leitungslänge										
		E0	E1 + E2	Leitung	Artikelbezeichnung	0,3m	0,6m	1m	2m	3m	5m	10m
		Kupplung, M12x1, axial 4 Pol, A	offenes Kabelende	PVC	YK-FK4M12-L/L/P00				8075696		8075697	8075698
				PUR	YK-FK4M12-L/L/S370				8075693		8075694	8075695
				PUR	YK-FK4M12-L/L/S7400				8075699		8075700	8075701
		Kupplung, M12x1, axial 4 Pol, A	Stecker, M12x1, axial 3 Pol, A	PVC	YK-FK4M12-2AL-WAS3-L/L/P00	8075999	8076005	8076011	8076014	8076018	8076021	
				PUR	YK-FK4M12-2AL-WAS3-L/L/S370	8075930	8075937	8075942	8075944	8075946	8075948	
				PUR	YK-FK4M12-2AL-WAS3-L/L/S7400	8076028	8076030	8076034	8076041	8076083	8076087	
		Kupplung, M12x1, axial 4 Pol, A	Stecker, M8x1, axial 3 Pol, A	PVC	YK-FK4M12-2AL-SSP3-L/L/P00	8075902	8075903	8075904	8075905	8075906	8075907	
				PUR	YK-FK4M12-2AL-SSP3-L/L/S370	8075852	8075890	8075891	8075892	8075893	8075894	
				PUR	YK-FK4M12-2AL-SSP3-L/L/S7400	8075908	8075909	8075910	8075922	8075925	8075927	
		Stecker, M12x1, axial 4 Pol, A	offenes Kabelende	PVC	YK-FS4M12-L/L/P00				8075705		8075706	8075707
				PUR	YK-FS4M12-L/L/S370				8075702		8075703	8075704
				PUR	YK-FS4M12-L/L/S7400				8075708		8075709	8075710
		Stecker, M12x1, axial 4 Pol, A	Kupplung, M12x1, axial 3 Pol, A	PVC	YK-FS4M12-2AL-WAK3-L/L/P00	8075968	8075969	8075970	8075971	8075973	8075979	
				PUR	YK-FS4M12-2AL-WAK3-L/L/S370	8075943	8075947	8075950	8075951	8075953	8075955	
				PUR	YK-FS4M12-2AL-WAK3-L/L/S7400	8075992	8075993	8075994	8075998	8076002	8076009	
		Stecker, M12x1, axial 4 Pol, A	Kupplung, M12x1, axial 4 Pol, A	PVC	YK-FS4M12-2AL-WAK4-L/L/P00	8076259	8076261	8076262	8076263	8076265	8076266	
				PUR	YK-FS4M12-2AL-WAK4-L/L/S370	8076222	8076224	8076226	8076227	8076228	8076230	
				PUR	YK-FS4M12-2AL-WAK4-L/L/S7400	8076286	8076288	8076289	8076291	8076292	8076294	
		Stecker, M12x1, axial 4 Pol, A	Kupplung, M12x1, gewinkelt 3 Pol, A	PVC	YK-FS4M12-2AL-WWAK3-L/L/P00	8076082	8076085	8076089	8076092	8076094	8076096	
				PUR	YK-FS4M12-2AL-WWAK3-L/L/S370	8076038	8076045	8076048	8076052	8076055	8076062	
				PUR	YK-FS4M12-2AL-WWAK3-L/L/S7400	8076108	8076109	8076110	8076111	8076112	8076113	

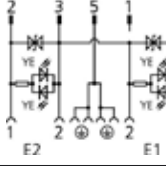
		L = Leitungslänge										
		E0	E1 + E2	Leitung	Artikelbezeichnung	0,3m	0,6m	1m	2m	3m	5m	10m
		Stecker, M12x1, axial 4 Pol, A	Kupplung, M12x1, gewinkelt 4 Pol, A	PVC	YK-FS4M12-2AL-WWAK4-L/L/P00	8076357	8076358	8076359	8076360	8076361	8076362	
				PUR	YK-FS4M12-2AL-WWAK4-L/L/S370	8076333	8076334	8076336	8076338	8076340	8076343	
				PUR	YK-FS4M12-2AL-WWAK4-L/L/S7400	8076367	8076368	8076369	8076370	8076371	8076372	
		Stecker, M12x1, axial 4 Pol, A	Kupplung, M12x1, gewinkelt, mit LED 3 Pol, A	PVC	YK-FS4M12-2AL-WWAK3P2-L/L/P00	8076126	8076127	8076129	8076130	8076132	8076134	
				PUR	YK-FS4M12-2AL-WWAK3P2-L/L/S370	8076117	8076119	8076121	8076123	8076124	8076125	
				PUR	YK-FS4M12-2AL-WWAK3P2-L/L/S7400	8076136	8076138	8076139	8076141	8076142	8076143	
		Stecker, M12x1, axial 4 Pol, A	Kupplung, M12x1, gewinkelt, mit LED 4 Pol, A	PVC	YK-FS4M12-2AL-WWAK4P2-L/L/P00	8076386	8076387	8076388	8076389	8076390	8076391	
				PUR	YK-FS4M12-2AL-WWAK4P2-L/L/S370	8076374	8076375	8076376	8076377	8076378	8076379	
				PUR	YK-FS4M12-2AL-WWAK4P2-L/L/S7400	8076395	8076396	8076397	8076398	8076399	8076400	
		Stecker, M12x1, axial 4 Pol, A	Kupplung, M8x1, axial 3 Pol, A	PVC	YK-FS4M12-2AL-SKP3-L/L/P00	8076114	8076115	8076116	8076118	8076120	8076122	
				PUR	YK-FS4M12-2AL-SKP3-L/L/S370	8076101	8076103	8076104	8076105	8076106	8076107	
				PUR	YK-FS4M12-2AL-SKP3-L/L/S7400	8076128	8076131	8076133	8076135	8076137	8076140	
		Stecker, M12x1, axial 4 Pol, A	Kupplung, M8x1, axial 4 Pol, A	PVC	YK-FS4M12-2AL-SKP4-L/L/P00	8075923	8075924	8075926	8075928	8075932	8075936	
				PUR	YK-FS4M12-2AL-SKP4-L/L/S370	8075914	8075917	8075918	8075919	8075920	8075921	
				PUR	YK-FS4M12-2AL-SKP4-L/L/S7400	8075938	8075939	8075940	8075941	8075945	8075949	
		Stecker, M12x1, axial 4 Pol, A	Kupplung, M8x1, gewinkelt 3 Pol, A	PVC	YK-FS4M12-2AL-SWKP3-L/L/P00	8076150	8076151	8076152	8076153	8076154	8076157	
				PUR	YK-FS4M12-2AL-SWKP3-L/L/S370	8076144	8076145	8076146	8076147	8076148	8076149	
				PUR	YK-FS4M12-2AL-SWKP3-L/L/S7400	8076268	8076270	8076272	8076275	8076280	8076284	
		Stecker, M12x1, axial 4 Pol, A	Kupplung, M8x1, gewinkelt 4 Pol, A	PVC	YK-FS4M12-2AL-SWKP4-L/L/P00	8076012	8076016	8076019	8076022	8076023	8076024	
				PUR	YK-FS4M12-2AL-SWKP4-L/L/S370	8075952	8075954	8075958	8075997	8076003	8076006	
				PUR	YK-FS4M12-2AL-SWKP4-L/L/S7400	8076025	8076026	8076027	8076029	8076032	8076035	

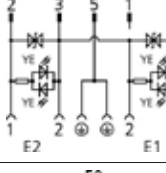
		L = Leitungslänge											
		E0	E1 + E2	Leitung	Artikelbezeichnung	0,3m	0,6m	1m	2m	3m	5m	10m	
		Stecker, M12x1, axial 4 Pol, A	Kupplung, M8x1, gewinkelt, mit LED 3 Pol, A	PVC	YK-FS4M12-2AL-SWKP3P2-L/L/P00	8075859	8076363	8076364	8076365	8076366	8076373		
				PUR	YK-FS4M12-2AL-SWKP3P2-L/L/S370	8076320	8076322	8076324	8076327	8076329	8076331		
				PUR	YK-FS4M12-2AL-SWKP3P2-L/L/S7400	8076380	8076381	8076382	8076383	8076384	8076385		
		Stecker, M12x1, axial 4 Pol, A	Kupplung, M8x1, gewinkelt, mit LED 4 Pol, A	PVC	YK-FS4M12-2AL-SWKP4P2-L/L/P00	8076049	8076050	8076057	8076061	8076064	8076067		
				PUR	YK-FS4M12-2AL-SWKP4P2-L/L/S370	8076039	8076042	8076043	8076044	8076046	8076047		
				PUR	YK-FS4M12-2AL-SWKP4P2-L/L/S7400	8076070	8076071	8076072	8076073	8076076	8076079		
		Kupplung, M8x1, axial 4 Pol, A	offenes Kabelende	PVC	YK-FK4M8-L/L/P00				8074375		8075666	8075667	
				PUR	YK-FK4M8-L/L/S370				8074373		8075664	8075665	
				PUR	YK-FK4M8-L/L/S7400				8074376		8075668	8075669	
		Kupplung, M8x1, axial 4 Pol, A	Stecker, M8x1, axial 3 Pol, A	PVC	YK-FK4M8-2AL-SSP3-L/L/P00	8075855	8075929	8075931	8075933	8075934	8075935		
				PUR	YK-FK4M8-2AL-SSP3-L/L/S370	8075846	8075911	8075912	8075913	8075915	8075916		
				PUR	YK-FK4M8-2AL-SSP3-L/L/S7400	8075961	8075963	8075964	8075965	8075966	8075967		
		Kupplung, M8x1, axial 4 Pol, A	Stecker, M12x1, axial 3 Pol, A	PVC	YK-FK4M8-2AL-WAS3-L/L/P00	8075995	8075996	8076000	8076001	8076004	8076007		
				PUR	YK-FK4M8-2AL-WAS3-L/L/S370	8075980	8075981	8075982	8075984	8075986	8075989		
				PUR	YK-FK4M8-2AL-WAS3-L/L/S7400	8076059	8076063	8076065	8076066	8076068	8076069		
		Stecker, M8x1, axial 4 Pol, A	Stecker, M12x1, axial 3 Pol, A	PVC	YK-FS4M8-2AL-WAK3-L/L/P00	8076231	8076232	8076233	8076234	8076236	8076239		
				PUR	YK-FS4M8-2AL-WAK3-L/L/S370	8076215	8076219	8076221	8076223	8076225	8076229		
				PUR	YK-FS4M8-2AL-WAK3-L/L/S7400	8076243	8076244	8076245	8076246	8076247	8076248		
		Stecker, M8x1, axial 4 Pol, A	Kupplung, M12x1, axial 4 Pol, A	PVC	YK-FS4M8-2AL-WAK4-L/L/P00	8076235	8076237	8076238	8076240	8076241	8076242		
				PUR	YK-FS4M8-2AL-WAK4-L/L/S370	8076213	8076214	8076216	8076217	8076218	8076220		
				PUR	YK-FS4M8-2AL-WAK4-L/L/S7400	8076250	8076251	8076253	8076255	8076256	8076258		

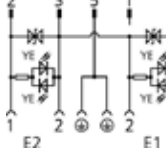
		L = Leitungslänge											
		E0	E1 + E2	Leitung	Artikelbezeichnung	0,3m	0,6m	1m	2m	3m	5m	10m	
		Stecker, M8x1, axial 4 Pol, A	Kupplung, M12x1, gewinkelt 3 Pol, A	PVC	YK-FS4M8-2AL-WWAK3-L/L/P00	8076267	8076269	8076271	8076273	8076276	8076283		
				PUR	YK-FS4M8-2AL-WWAK3-L/L/S370	8076249	8076252	8076254	8076257	8076260	8076264		
				PUR	YK-FS4M8-2AL-WWAK3-L/L/S7400	8076285	8076287	8076290	8076293	8076295	8076296		
		Stecker, M8x1, axial 4 Pol, A	Kupplung, M12x1, gewinkelt 4 Pol, A	PVC	YK-FS4M8-2AL-WWAK4-L/L/P00	8076297	8076298	8076300	8076301	8076302	8076303		
				PUR	YK-FS4M8-2AL-WWAK4-L/L/S370	8076274	8076277	8076278	8076279	8076281	8076282		
				PUR	YK-FS4M8-2AL-WWAK4-L/L/S7400	8076309	8076311	8076312	8076315	8076318	8076319		
		Stecker, M8x1, axial 4 Pol, A	Kupplung, M12x1, gewinkelt, mit LED 3 Pol, A	PVC	YK-FS4M8-2AL-WWAK3P2-L/L/P00	8076310	8076313	8076314	8076316	8076317	8076321		
				PUR	YK-FS4M8-2AL-WWAK3P2-L/L/S370	8076299	8076304	8076305	8076306	8076307	8076308		
				PUR	YK-FS4M8-2AL-WWAK3P2-L/L/S7400	8076323	8076325	8076326	8076328	8076330	8076332		
		Stecker, M8x1, axial 4 Pol, A	Kupplung, M12x1, gewinkelt, mit LED 4 Pol, A	PVC	YK-FS4M8-2AL-WWAK4P2-L/L/P00	8076345	8076346	8076347	8076348	8076349	8076350		
				PUR	YK-FS4M8-2AL-WWAK4P2-L/L/S370	8076335	8076337	8076339	8076341	8076342	8076344		
				PUR	YK-FS4M8-2AL-WWAK4P2-L/L/S7400	8076351	8076352	8076353	8076354	8076355	8076356		
		Stecker, M8x1, axial 4 Pol, A	offenes Kabelende	PVC	YK-FS4M8-L/L/P00				8074377		8075672	8075673	
				PUR	YK-FS4M8-L/L/S370				8074374		8075670	8075671	
				PUR	YK-FS4M8-L/L/S7400				8074378		8075674	8075675	
		Stecker, M8x1, axial 4 Pol, A	Kupplung, M8x1, axial 3 Pol, A	PVC	YK-FS4M8-2AL-SKP3-L/L/P00	8075972	8075974	8075975	8075976	8075977	8075978		
				PUR	YK-FS4M8-2AL-SKP3-L/L/S370	8075857	8075956	8075957	8075959	8075960	8075962		
				PUR	YK-FS4M8-2AL-SKP3-L/L/S7400	8075983	8075985	8075987	8075988	8075990	8075991		
		Stecker, M8x1, axial 4 Pol, A	Kupplung, M8x1, axial 4 Pol, A	PVC	YK-FS4M8-2AL-SKP4-L/L/P00	8076162	8076163	8076164	8076165	8076166	8076167		
				PUR	YK-FS4M8-2AL-SKP4-L/L/S370	8076155	8076156	8076158	8076159	8076160	8076161		
				PUR	YK-FS4M8-2AL-SKP4-L/L/S7400	8076168	8075856	8076169	8076170	8076171	8076172		

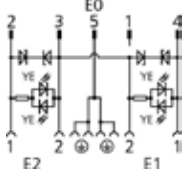
		L = Leitungslänge										
		E0	E1 + E2	Leitung	Artikelbezeichnung	0,3m	0,6m	1m	2m	3m	5m	10m
		Stecker, M8x1, axial 4 Pol, A	Kupplung, M8x1, gewinkelt 3 Pol, A	PVC	YK-FS4M8-2AL-SWKP3-L/L/P00	8075858	8076031	8076033	8076036	8076037	8076040	
				PUR	YK-FS4M8-2AL-SWKP3-L/L/S370	8076008	8076010	8076013	8076015	8076017	8076020	
				PUR	YK-FS4M8-2AL-SWKP3-L/L/S7400	8076051	8076053	8076054	8076056	8076058	8076060	
		Stecker, M8x1, axial 4 Pol, A	Kupplung, M8x1, gewinkelt 4 Pol, A	PVC	YK-FS4M8-2AL-SWKP4/L/L/P00	8076392	8076393	8076394	8076401	8076402	8076403	
				PUR	YK-FS4M8-2AL-SWKP4/L/L/S370	8076173	8076174	8076175	8076176	8076177	8076178	
				PUR	YK-FS4M8-2AL-SWKP4/L/L/S7400	8076404	8076405	8076406	8076407	8076408	8076409	
		Stecker, M8x1, axial 4 Pol, A	Kupplung, M8x1, gewinkelt, mit LED 3 Pol, A	PVC	YK-FS4M8-2AL-SWKP3P2-L/L/P00	8076084	8076086	8076088	8076090	8076091	8076093	
				PUR	YK-FS4M8-2AL-SWKP3P2-L/L/S370	8076074	8076075	8076077	8076078	8076080	8076081	
				PUR	YK-FS4M8-2AL-SWKP3P2-L/L/S7400	8076095	8076097	8076098	8076099	8076100	8076102	
		Stecker, M8x1, axial 4 Pol, A	Kupplung, M8x1, gewinkelt, mit LED 4 Pol, A	PVC	YK-FS4M8-2AL-SWKP4P2-L/L/P00	8076419	8076420	8076421	8076422	8076423	8076424	
				PUR	YK-FS4M8-2AL-SWKP4P2-L/L/S370	8076413	8076414	8076415	8076416	8076417	8076418	
				PUR	YK-FS4M8-2AL-SWKP4P2-L/L/S7400	8076425	8076426	8076427	8076428	8076429	8076430	
		Stecker, M12x1, axial 5 Pol, A	Kupplung, Ventil A, gewinkelt 2+PE, PE gebrückt Pol	PVC	YK-FS5M12-2VA22-24.3-L/L/P00	8077612	8077671	8077614	8077615	8077616	8077617	
				PUR	YK-FS5M12-2VA22-24.3-L/L/S370	8077604	8077606	8077608	8077609	8077610	8077611	
		Stecker, M12x1, axial 5 Pol, A	Kupplung, Ventil B, axial 2+PE Pol	PVC	YK-FS5M12-2VB21-24.3-L/L/P00	8077627	8077673	8077631	8077633	8077635	8077637	
				PUR	YK-FS5M12-2VB21-24.3-L/L/S370	8077618	8077672	8077620	8077621	8077623	8077625	
		Stecker, M12x1, axial 5 Pol, A	Kupplung, Ventil BI, gewinkelt 2+PE Pol	PVC	YK-FS5M12-2VBI21-24.3-L/L/P00	8077603	8077605	8077607	8077622	8077624	8077626	
				PUR	YK-FS5M12-2VBI21-24.3-L/L/S370	8077639	8077674	8077644	8077646	8077648	8077651	

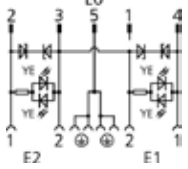
		L = Leitungslänge										
		E0	E1 + E2	Leitung	Artikelbezeichnung	0,3m	0,6m	1m	2m	3m	5m	10m
		Stecker, M12x1, axial 5 Pol, A	Kupplung, Ventil C, gewinkelt 2+PE, PE gebrückt Pol	PVC	YK-FS5M12-2VC22-24.4-L/L/P00	8077640	8077641	8077643	8077645	8077647	8077649	
				PUR	YK-FS5M12-2VC22-24.4-L/L/S370	8077628	8077630	8077632	8077634	8077636	8077638	
		Stecker, M12x1, axial 5 Pol, A	Kupplung, Ventil CI, gewinkelt 2+PE, PE gebrückt Pol	PVC	YK-FS5M12-2VCI22-24.4-L/L/P00	8077658	8077659	8077660	8077661	8077663	8077664	
				PUR	YK-FS5M12-2VCI22-24.4-L/L/S370	8077650	8077652	8077654	8077655	8077656	8077657	

Nomenklatur

8	I/O	M8-	3	P2	T	L	/S370
Anzahl der I/O-Steckplätze		Steckplatzanschluss: M8x1, Ø8mm snap (S8) M12x1		PNP Anzahl der LEDs + Beschaltung		Leitungslänge [m] bei Festkabelanschluss C	
I/O-Verteiler		Kontaktanzahl, Anschlussbelegung		Anschlussart T: top F: front C: Festkabel		Leitungsqualität	

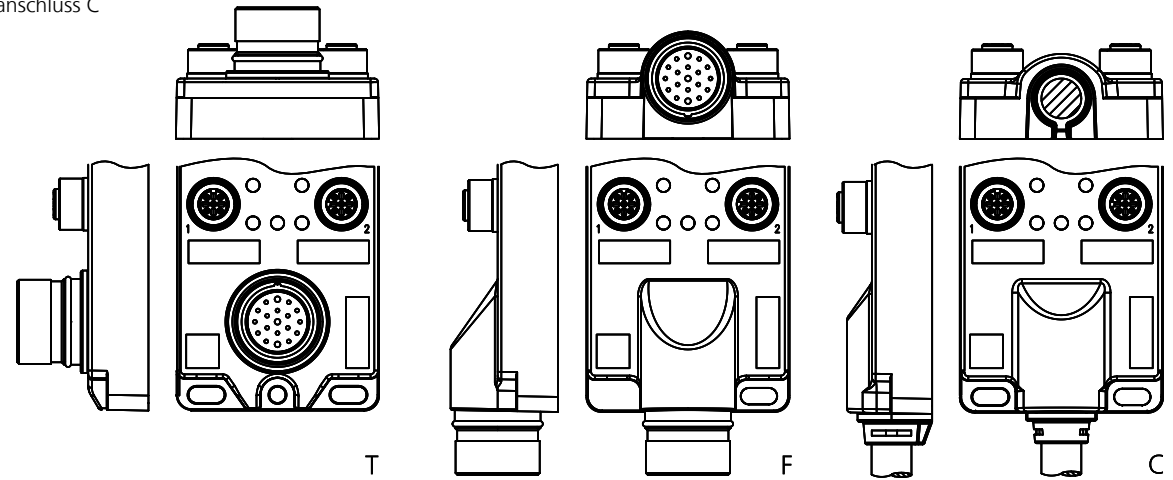

I/O-Verteiler Passiv

Leitung	Kurzbeschreibung
P01 PVC	Flexible PVC/PVC Sensor-/Aktorsteuerleitung für mittlere mechanische Beanspruchungen. Bedingt öl- und chemikalienbeständig, mit UL-Style.
S370 PUR	Flexible PUR/PP Sensor-/Aktorsteuerleitung für starke mechanische Beanspruchungen. Halogenfrei, flammwidrig, gute Torsions- und Schleppkettentauglichkeit, öl- und chemikalienbeständig, mit UL-Style.











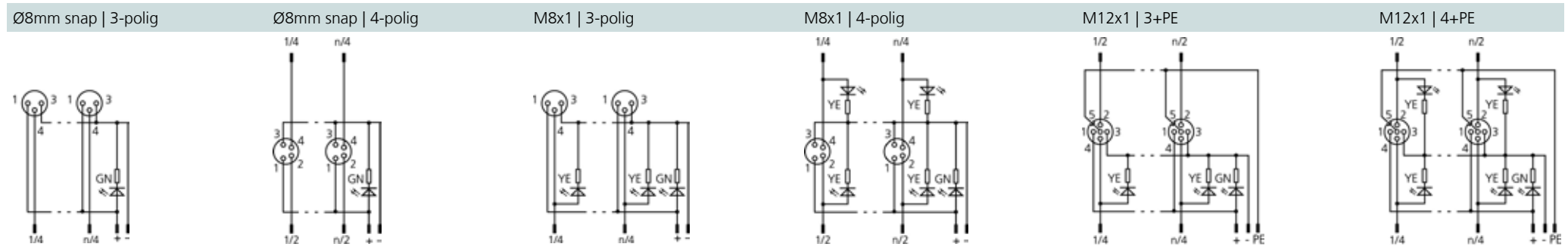



Abbildung im Maßstab ~ 1:2

I/O-Verteiler Passiv

Technische Daten	M12x1	M8x1	Ø8mm snap
Isolationswiderstand	$\geq 10^8 \Omega$	$\geq 10^8 \Omega$	$\geq 10^8 \Omega$
Durchgangswiderstand	$\leq 5 m\Omega$	$\leq 5 m\Omega$	$\leq 5 m\Omega$
Umgebungstemperatur	-30°C...+90°C	-30°C...+90°C	-30°C...+90°C
Material Kontakte	Metall, CuZn, vergoldet	Metall, CuZn, vergoldet	Metall, CuZn, vergoldet
Material Kontaktträger	Kunststoff, PA, BK	Kunststoff, PA, BK	Kunststoff, PA, BK
Material Dichtung (Kupplung)	FPM/FKM	FPM/FKM	FPM/FKM
Normen	IEC 61076-2-101	IEC 61076-2-104	IEC 61076-2-104
Schutzart (montiert)	IP65, IP67	IP65, IP67	IP65, IP67
Mechanische Lebensdauer	>100 Steckzyklen	>100 Steckzyklen	>100 Steckzyklen
Verschmutzungsgrad	3	3	3

M8x1- und M12x1-Passivverteiler von ESCHA zeichnen sich insbesondere durch ihre kompakte Bauform sowie ihre flexiblen Befestigungsmöglichkeiten aus. Durch den bewährten Vollverguss und einen Metall-Gewindeinsatz sind unsere Verteiler prädestiniert für den rauen Industrieinsatz und erfüllen die hohen Anforderungen der Schutzarten IP65 und IP67. Durch unterschiedliche Anschlussmöglichkeiten (Festkabelanschluss, front- oder stirnseitiger Anschlussstecker) finden Sie immer das passende Produkt.

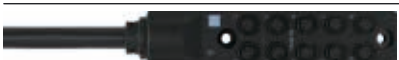
		I/O					L = Leitungslänge				
			Eingang	Ausgang	ΣI [max]	Artikelbezeichnung	Stecker	2m	5m	10m	15m
	I/O Verteiler Passiv, M12x1, Top	4	3+PE	M23x1, 12-polig	12A	4I/OM12-5.4P2T	8048790				
			4+PE	M23x1, 19-polig	12A	4I/OM12-5P3T	8045895				
	I/O Verteiler Passiv, M12x1, Front	4	3+PE	M23x1, 12-polig	12A	4I/OM12-5.4P2F	8048791				
			4+PE	M23x1, 19-polig	12A	4I/OM12-5P3F	8045891				
	I/O Verteiler Passiv, M12x1, Festkabel	4	3+PE		12A	4I/OM12-5.4P2C-L/S370	8048792				
			4+PE		12A	4I/OM12-5P3C-L/S370	8045894				
	I/O Verteiler Passiv, M12x1, Top	6	3+PE	M23x1, 12-polig	12A	6I/OM12-5.4P2T	8048787				
			4+PE	M23x1, 19-polig	12A	6I/OM12-5P3T	8045896				
	I/O Verteiler Passiv, M12x1, Front	6	3+PE	M23x1, 12-polig	12A	6I/OM12-5.4P2F	8048788				
			4+PE	M23x1, 19-polig	12A	6I/OM12-5P3F	8045892				
	I/O Verteiler Passiv, M12x1, Festkabel	6	3+PE		12A	6I/OM12-5.4P2C-L/S370	8048789				
			4+PE		12A	6I/OM12-5P3C-L/S370	8045893				
	I/O Verteiler Passiv, M12x1, Top	8	3+PE	M23x1, 12-polig	12A	8I/OM12-5.4P2T	8048784				
			4+PE	M23x1, 19-polig	12A	8I/OM12-5P3T	8045647				
	I/O Verteiler Passiv, M12x1, Front	8	3+PE	M23x1, 12-polig	12A	8I/OM12-5.4P2F	8048785				
			4+PE	M23x1, 19-polig	12A	8I/OM12-5P3F	8045649				
	I/O Verteiler Passiv, M12x1, Festkabel	8	3+PE		12A	8I/OM12-5.4P2C-L/S370	8048786				
			4+PE		12A	8I/OM12-5P3C-L/S370	8045648				
	I/O Verteiler Passiv, M8x1, Top	4	3	M12x1, 8-polig	2A	4I/OM8-3P2T	8061747				

		I/O					L = Leitungslänge				
			Eingang	Ausgang	ΣI [max]	Artikelbezeichnung	Stecker	2m	5m	10m	15m
	I/O Verteiler Passiv, M8x1, Festkabel	4	3		6A	4I/OM8-3P2C-L/S370		8061768	8061776	8061777	8061778
			4		6A	4I/OM8-4P3C-L/S370		8061783	8061784	8061785	8061786
	I/O Verteiler Passiv, M8x1, Top	8	3	M12x1, 12-polig	1,5A	8I/OM8-3P2T		8061744			
	I/O Verteiler Passiv, M8x1, Festkabel	8	3		6A	8I/OM8-3P2C-L/S370		8061794	8061796	8061797	8061798
			4		6A	8I/OM8-4P3C-L/S370		8061803	8061804	8061805	8061806
	I/O Verteiler Passiv, M8x1, Top	10	3	M12x1, 12-polig	1,5A	10I/OM8-3P2T		8061633			
	I/O Verteiler Passiv, M8x1, Festkabel	10	3		6A	10I/OM8-3P2C-L/S370		8061811	8061812	8061813	8061814
	I/O Verteiler Passiv, Ø8mm snap, Festkabel	4	3		6A	4I/OS8-3P1C-L/P01		8062806	8062807	8062808	8062809
			3		6A	4I/OS8-3P1C-L/S370		8062789	8062790	8062791	8062792
			4		6A	4I/OS8-4P1C-L/P01		8062817	8062818	8062819	8062820
			4		6A	4I/OS8-4P1C-L/S370		8062813	8062814	8062815	8062816
	I/O Verteiler Passiv, Ø8mm snap, Top	4	3	M12x1, 8-polig	4A	4I/OS8-3P1T		8062601			
			4	M12x1, 12-polig	1,5A	4I/OS8-4P1T		8062599			
	I/O Verteiler Passiv, Ø8mm snap, Festkabel	10	3		6A	10I/OS8-3P1C-L/P01		8062838	8062839	8062840	8062841
			3		6A	10I/OS8-3P1C-L/S370		8062825	8062826	8062827	8062828
	I/O Verteiler Passiv, Ø8mm snap, Top	10	3	M12x1, 12-polig	1,5A	10I/OS8-3P1T		8062604			

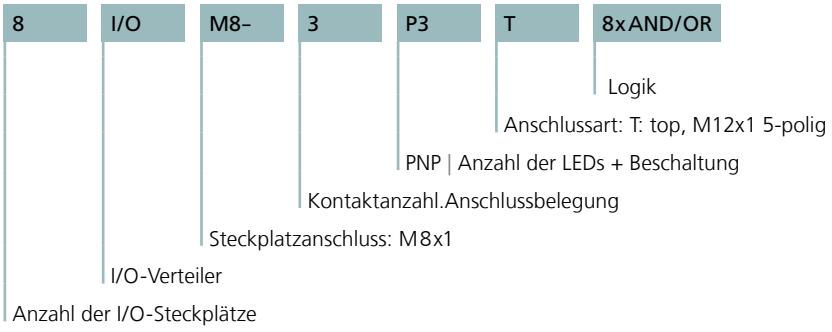

*nicht 8062606, 8062608 und 8062610











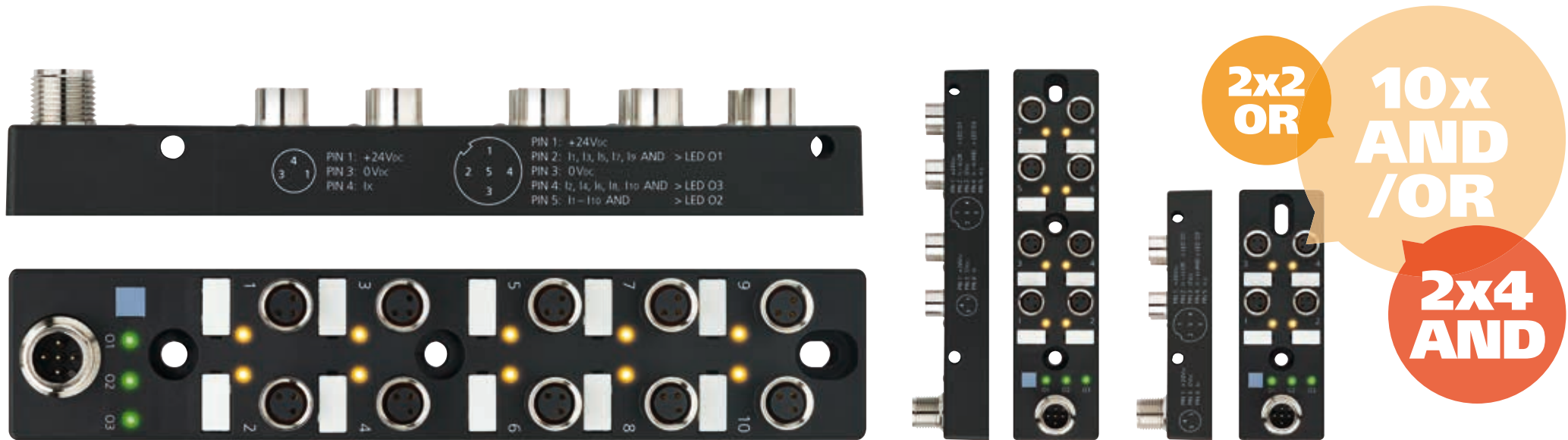

























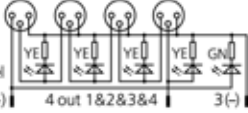

Abbildung im Maßstab ca. 1:1

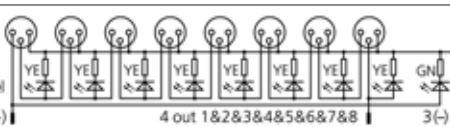
I/O-Verteiler Logik

Die äußerst kompakten M8x1 I/O-Verteiler mit aktiver Logikfunktion platzieren Intelligenz nahe an Sensoren und übermitteln vorverarbeitete Signale an eine zentrale Steuerungseinheit. Im Gegensatz zu herkömmlichen Passivverteilern oder Feldbusverteilern können sie auf ein ungeschirmtes 4- oder 5-poliges Sensorkabel zurückgreifen. Dadurch werden Verdrahtungskosten sowie Verdrahtungszeit reduziert und Verdrahtungsfehler vermieden. Durch eine fest vorgegebene Logik müssen die Verteiler vom Anwender nicht programmiert werden und sind unmittelbar einsatzbereit. Sie eignen sich optimal für Greifer, Roboter oder kompakte Handlungseinheiten.

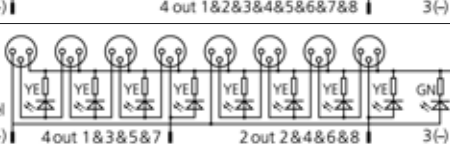
Technische Daten	M8x1
Isolationswiderstand	$\geq 10^8 \Omega$
Durchgangswiderstand	$\leq 5 m\Omega$
Umgebungstemperatur	-30°C...+90°C
Material Kontakte	Metall, CuZn, vergoldet
Material Kontakträger	Kunststoff, PA, BK
Material Dichtung (Kupplung)	FPM/FKM
Normen	IEC 61076-2-104
Schutzart (montiert)	IP65, IP67
Mechanische Lebensdauer	>100 Steckzyklen
Verschmutzungsgrad	3

		I/O		ΣI[<i>max</i>]	Artikelbezeichnung	Art.-Nr.	
	I/O Verteiler Logik, M8x1, Top 4x AND/OR Schaltungslogik	4	 PIN 1: +24Vdc PIN 3: 0Vdc PIN 4: Ix	 PIN 1: +24Vdc PIN 2: I1 - I4 OR > LED O1 PIN 3: 0Vdc PIN 4: I1 - I4 AND > LED O3 PIN 5: n.c.	4A	4I/OM8-3P3T 4x AND/OR	8081123
	I/O Verteiler Logik, M8x1, Top 2x2 AND Schaltungslogik	4	 PIN 1: +24Vdc PIN 3: 0Vdc PIN 4: Ix	 PIN 1: +24Vdc PIN 2: I1, I3 AND > LED O1 PIN 3: 0Vdc PIN 4: I2, I4 AND > LED O3 PIN 5: I1 - I4 AND > LED O2	4A	4I/OM8-3P4T 2x2 AND	8081125
	I/O Verteiler Logik, M8x1, Top 2x2 OR Schaltungslogik	4	 PIN 1: +24Vdc PIN 3: 0Vdc PIN 4: Ix	 PIN 1: +24Vdc PIN 2: I1, I3 OR > LED O1 PIN 3: 0Vdc PIN 4: I2, I4 OR > LED O3 PIN 5: I1 - I4 OR > LED O2	4A	4I/OM8-3P4T 2x2 OR	8081127
	I/O Verteiler Logik, M8x1, Top 8x AND/OR Schaltungslogik	8	 PIN 1: +24Vdc PIN 3: 0Vdc PIN 4: Ix	 PIN 1: +24Vdc PIN 2: I1 - I8 OR > LED O1 PIN 3: 0Vdc PIN 4: I1 - I8 AND > LED O3 PIN 5: n.c.	4A	8I/OM8-3P3T 8x AND/OR	8081129
	I/O Verteiler Logik, M8x1, Top 2x4 AND Schaltungslogik	8	 PIN 1: +24Vdc PIN 3: 0Vdc PIN 4: Ix	 PIN 1: +24Vdc PIN 2: I1, I3, I5, I7 AND > LED O1 PIN 3: 0Vdc PIN 4: I2, I4, I6, I8 AND > LED O3 PIN 5: I1 - I8 AND > LED O2	4A	8I/OM8-3P4T 2x4 AND	8081131
	I/O Verteiler Logik, M8x1, Top 2x4 OR Schaltungslogik	8	 PIN 1: +24Vdc PIN 3: 0Vdc PIN 4: Ix	 PIN 1: +24Vdc PIN 2: I1, I3, I5, I7 OR > LED O1 PIN 3: 0Vdc PIN 4: I2, I4, I6, I8 OR > LED O3 PIN 5: I1 - I8 OR > LED O2	4A	8I/OM8-3P4T 2x4 OR	8081133
	I/O Verteiler Logik, M8x1, Top 10x AND/OR Schaltungslogik	10	 PIN 1: +24Vdc PIN 3: 0Vdc PIN 4: Ix	 PIN 1: +24Vdc PIN 2: I1 - I10 OR > LED O1 PIN 3: 0Vdc PIN 4: I1 - I10 AND > LED O3 PIN 5: n.c.	4A	10I/OM8-3P3T 10x AND/OR	8081135
	I/O Verteiler Logik, M8x1, Top 2x5 AND Schaltungslogik	10	 PIN 1: +24Vdc PIN 3: 0Vdc PIN 4: Ix	 PIN 1: +24Vdc PIN 2: I1, I3, I5, I7, I9 AND > LED O1 PIN 3: 0Vdc PIN 4: I2, I4, I6, I8, I10 AND > LED O3 PIN 5: I1 - I10 AND > LED O2	4A	10I/OM8-3P4T 2x5 AND	8081137
	I/O Verteiler Logik, M8x1, Top 4x AND Schaltungslogik	4	 U _{max} : 30V I _g : 4A I _{max} : 2A/channel LEDvt: signal 1(+) 		4A	4I/OM8-3P2T 4x passiv AND	8062606
	I/O Verteiler Logik, M8x1, Top 8x AND Schaltungslogik	8	 U _{max} : 30V I _g : 4A I _{max} : 2A/channel LEDvt: signal 1(+) 		4A	8I/OM8-3P2T 8x passiv AND	8062608
	I/O Verteiler Logik, M8x1, Top 2x4 AND Schaltungslogik	8	 U _{max} : 30V I _g : 4A I _{max} : 2A/channel LEDvt: signal 1(+) 		4A	8I/OM8-3P2T 2x4 passiv AND	8062610
	Simulationsstecker Stecker, M8x1, axial	3		für unbelegte I/O	AL-SSP3-AS/S2065	8063927	



Nomenklatur

W	MK	C	E	C	U	19-	L	.001	L	/S370
										Leitungsqualität
										Leitungslänge [m] inkl. Aderendhülsen
										Anschlussbelegung
										Anschlussart für selbstkonfektionierbare L: Lötkontakt C: Crimpkontakt
						Polzahl				
					umspritzt					
						Rundsteckverbinder M23x1				
						Edelstahlüberwurfmutter				
						selbstkonfektionierbar				
						Kupplung				
						W: gewinkelt ohne: axial				



Leitung	Kurzbeschreibung
S370 PUR	Flexible PUR/PP Sensor-/Aktorsteuerleitung für starke mechanische Beanspruchungen. Halogenfrei, flammwidrig, gute Torsions- und Schleppkettentauglichkeit, öl- und chemikalienbeständig, mit UL-Style.

M23x1







Abbildung im Maßstab ~ 1:1

M23x1

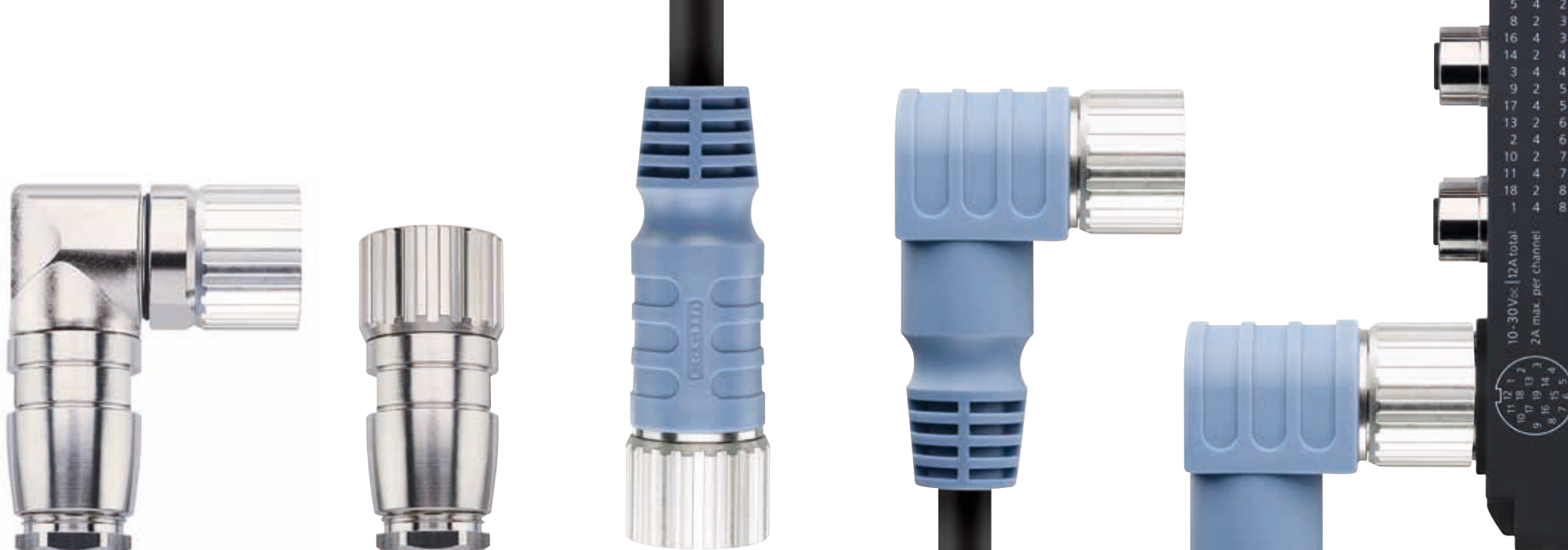
Technische Daten	M23x1	Selbstkonfektionierbar
Isolationswiderstand	$\geq 10^8 \Omega$	$\geq 10^8 \Omega$
Umgebungstemperatur	-30°C...+90°C	-40°C...+85°C
Material Kontakte	Metall, vergoldet	Metall, CuZn, vergoldet
Material Kontaktträger	Kunststoff, PBT	Kunststoff, PBT, GY
Material Griffkörper	Kunststoff, TPU	Metall, CuZn, vernickelt, versilbert
Material Überwurf	Metall, vernickelt	Metall, CuZn, vernickelt
Material Dichtung (Kupplung)	Kunststoff, NBR	Kunststoff, NBR
Schutzart (montiert)	IP65, IP67	
Mechanische Lebensdauer	>100 Steckzyklen	>100 Steckzyklen
Verschmutzungsgrad	3	3
Kabeldurchlass		12-polig: 8...12mm 19-polig: 10...14mm
Anschlussquerschnitt		12-polig: Kontakt 10, 11, 12: 0,75...1,0mm ² übrige 0,5...0,75mm ² 19-polig: Kontakt 9, 12, 19: 0,75...1,0mm ² übrige 0,5...0,75mm ²
Anschlussart		Lötanschluss

Die konfektionierten und selbstkonfektionierbaren M23x1-Steckverbinder sind als Anschlussleitungen ideal auf unsere M12x1-Passivverteiler abgestimmt. Es stehen Ihnen 12- und 19-polige Varianten mit unterschiedlichen Belegungen zur Verfügung. Dank der exklusiv bei ESCHA erhältlichen PUR-Leitung namens ‚S370‘ sind die M23x1-Steckverbinder mit nur einer Leitungsqualität in unterschiedlichen Applikationsbereichen einsetzbar.

		Kopf			Leitung			Artikelbezeichnung	L = Leitungslänge*		
		Pol	U[max]	I[max]	Material	Farbe	UL		2m / 1m	5m / 2m	10m / 5m
	Anschlussleitung Kupplung, M23x1, axial	12	125V	4A 8A (Kontakt 10,11,12)	PUR	BK		MKCU12.001-L/S370	8027363	8026032	8026033
		12	125V	4A 8A (Kontakt 10,11,12)	PUR	BK		MKCU12.003-L/S370	8026243	8026039	8026041
		19	125V	4A 10A (Kontakt 9,12,19)	PUR	BK		MKCU19.001-L/S370	8027364	8026036	8026037
		19	125V	4A 10A (Kontakt 9,12,19)	PUR	BK		MKCU19.003-L/S370	8027365	8017221	8017222
	Anschlussleitung Kupplung, M23x1, gewinkelt	12	125V	4A 8A (Kontakt 10,11,12)	PUR	BK		WMKCU12.001-L/S370	8027366	8026043	8026044
		12	125V	4A 8A (Kontakt 10,11,12)	PUR	BK		WMKCU12.003-L/S370	8026244	8026049	8026050
		19	125V	4A 10A (Kontakt 9,12,19)	PUR	BK		WMKCU19.001-L/S370	8027368	8026046	8026047
		19	125V	4A 10A (Kontakt 9,12,19)	PUR	BK		WMKCU19.003-L/S370	8027370	8017111	8017112
	Steckverbinder selbstkonfektionierbar Kupplung, M23x1, axial Lötanschluss	12	150V	4A 8A (Kontakt 10,11,12)				MKCC12L	8013694		
		19	125V	4A 10A (Kontakt 9,12,19)				MKCC19L	8013696		
	Steckverbinder selbstkonfektionierbar Kupplung, M23x1, gewinkelt Lötanschluss	12	150V	4A 8A (Kontakt 10,11,12)				WMKCC12L	8017153		
		19	125V	4A 10A (Kontakt 9,12,19)				WMKCC19L	8017151		

* Unsere Standardleitungslängen sind 2m, 5m oder 10m für Anschlussleitungen und 1m, 2m oder 5m für Verbindungsleitungen. Die Litzenlänge bei Flanschen beträgt 0,5m (POWER 0,2m). Alle anderen Leitungs- und Litzenlängen liefern wir Ihnen gern auf Anfrage.

Bauform	Kontakte	$U_{[max]}$	Beschaltung	Leitungslänge	B-Seite
VA A	21 2+PE	24 24V _{DC} 24V _{AC/DC}	0 keine	L Anschluss-, Verbindungsltg.	offenes Kabelende
VAA A gerade	22 2+PE gebrückt	60 60V _{AC/DC}	1 LED	L1/L2 Doppelventilstecker	DA 22-24.3 Doppelventilstecker
VAAG A gerade Gewindebauform	31 3+PE	230 230V _{AC/DC}	2 LED, Druckschalter		WAS5.002 Ventil-M12x1 Adapter
VB B (10mm Kontaktabstand)	41 3+PE+Litzenanschluss		3 LED + Transilodiode		
VBI BI (11mm Kontaktabstand)			4 LED + Z-Dioden		
VC C (8mm Kontaktabstand)			5 LED + Varistor		
VCI CI (9,4mm Kontaktabstand)					

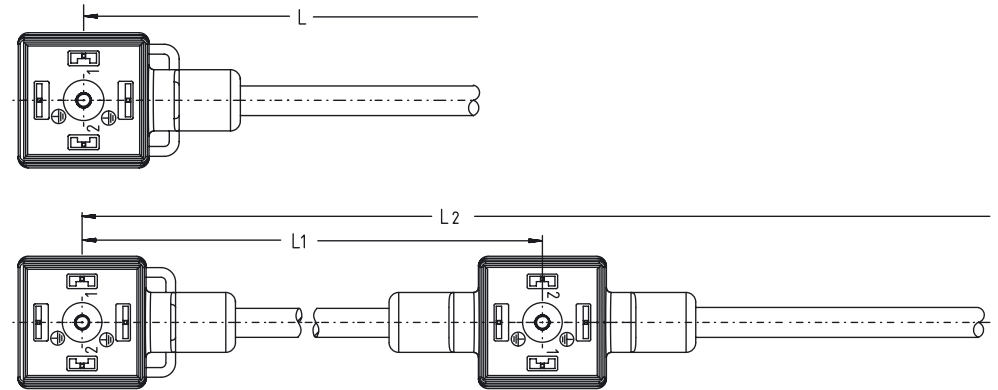
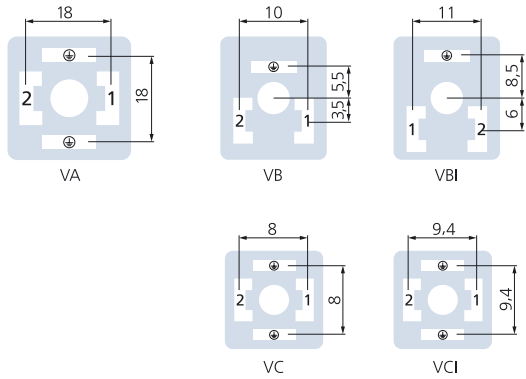

Leitung	Kurzbeschreibung
P00 PVC	Flexible PVC/PVC Sensor-/Aktorsteuerleitung für mittlere mechanische Beanspruchungen. Bedingt öl- und chemikalienbeständig.
P01 PVC	Flexible PVC/PVC Sensor-/Aktorsteuerleitung für mittlere mechanische Beanspruchungen. Bedingt öl- und chemikalienbeständig, mit UL-Style.
S370 PUR	Flexible PUR/PP Sensor-/Aktorsteuerleitung für starke mechanische Beanspruchungen. Halogenfrei, flammwidrig, gute Torsions- und Schleppkettentauglichkeit, öl- und chemikalienbeständig, mit UL-Style.







Abbildung im Maßstab ~ 1:1

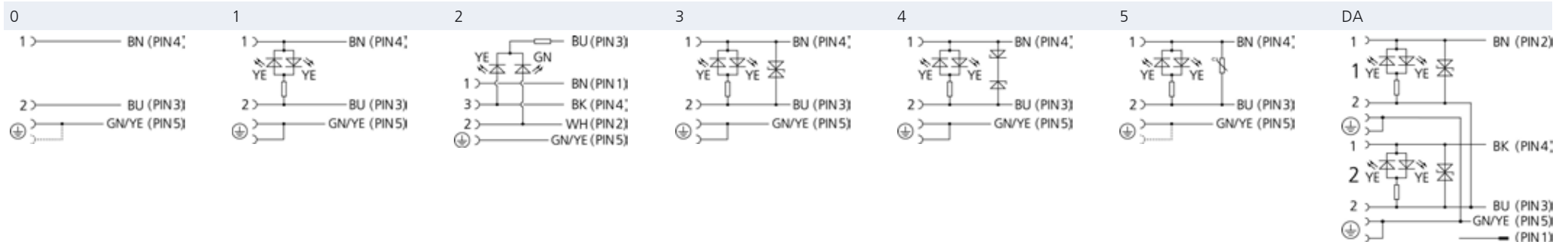

Ventilsteckverbinder

Technische Daten	Ventilsteckverbinder	M12x1 (Adapter, Doppelventilsteckverbinder)
Isolationswiderstand	≥10 ⁸ Ω	≥10 ⁸ Ω
Umgebungstemperatur	-30°C...+90°C	-30°C...+90°C
Material Kontakte	Metall, versilbert	Metall, vergoldet
Material Kontaktträger	Kunststoff, PA	Kunststoff, TPU
Material Griffkörper	Kunststoff, TPU	Kunststoff, TPU
Material Dichtung (Kupplung)	Kunststoff, TPU	
Normen	DIN EN 175301-803	IEC 61076-2-101
Schutzart (montiert)	IP65, IP67, IP68	IP65, IP67, IP68
Mechanische Lebensdauer	>100 Steckzyklen	>100 Steckzyklen
Verschmutzungsgrad	3	3





ESCHA Ventilsteckverbinder stehen für minimalen Bauraum bei gleichzeitig rundum sichtbarer LED-Statusanzeige. Alle gängigen Bauformen und Schutzbeschriftungen werden unterstützt. Ein umfangreiches Produktprogramm mit Anschluss- und Verbindungsleitungen sowie Adaptern und Doppelventil-Steckverbindern bietet für jeden Applikationsbereich die passende Lösung.

		Kopf			Leitung			Artikelbezeichnung	L / L2 = Leitungslänge			
		Pole	U[max]	Beschaltung	Material	Farbe	L1[m]		2m / 1m	5m / 2m	10m / 5m	
	Anschlussleitung Kupplung, Ventil A, gewinkelt	2+PE	230V _{AC/DC}	ohne	PUR	BK		VA21-230.0-L/S370	8050753	8047806	8050754	
			230V _{AC/DC}	ohne	PVC	GY		VA21-230.0-L/P00	8048838	8048841	8050824	
			230V _{AC/DC}	ohne	PVC	GY		VA21-230.0-L/P01	8050873	8047823	8050874	
		2+PE, PE gebrückt	230V _{AC/DC}	ohne	PUR	BK		VA22-230.0-L/S370	8052299	8052300	8052301	
			230V _{AC/DC}	ohne	PVC	GY		VA22-230.0-L/P00	8052302	8052303	8052304	
			230V _{AC/DC}	ohne	PVC	GY		VA22-230.0-L/P01	8052305	8052306	8052307	
			230V _{AC/DC}	Varistor	PUR	BK		VA22-230.5-L/S370	8050755	8046704	8050756	
			230V _{AC/DC}	Varistor	PVC	GY		VA22-230.5-L/P00	8050827	8048819	8050828	
			230V _{AC/DC}	Varistor	PVC	GY		VA22-230.5-L/P01	8050875	8047824	8050876	
			24V _{AC/DC}	ohne	PUR	BK		VA22-24.1-L/S370	8050501	8047803	8048240	
			24V _{AC/DC}	ohne	PVC	GY		VA22-24.1-L/P00	8050819	8048818	8050820	
			24V _{AC/DC}	ohne	PVC	GY		VA22-24.1-L/P01	8050861	8046613	8050862	
			24V _{AC/DC}	Transildiode	PUR	BK		VA22-24.3-L/S370	8050293	8047804	8048527	
			24V _{AC/DC}	Transildiode	PVC	GY		VA22-24.3-L/P00	8048840	8048839	8049537	
			24V _{AC/DC}	Transildiode	PVC	GY		VA22-24.3-L/P01	8049306	8047821	8050863	
			3+PE	230V _{AC/DC}	ohne	PUR	BK		VA31-230.0-L/S370	8058325	8059241	8059242
				230V _{AC/DC}	ohne	PVC	GY		VA31-230.0-L/P00	8061939	8066062	8062016
				230V _{AC/DC}	ohne	PVC	GY		VA31-230.0-L/P01	8081356	8081355	8061577
24V _{AC/DC}	Transildiode	PUR		BK		VA31-24.3-L/S370	8067058	8065473	8078853			
24V _{AC/DC}	Transildiode	PVC		GY		VA31-24.3-L/P00	8081328	8081329	8081330			
24V _{AC/DC}	Transildiode	PVC		GY		VA31-24.3-L/P01	8081331	8081332	8081333			
3+PE Litze	24V _{DC}	ohne	PUR	BK		VA41-24.2-L/S370	8050500	8047805	8049933			
	24V _{DC}	ohne	PVC	GY		VA41-24.2-L/P00	8050822	8049310	8050540			
	24V _{DC}	ohne	PVC	GY		VA41-24.2-L/P01	8050865	8047822	8050866			
	Anschlussleitung Kupplung, Ventil AA, axial	2+PE	230V _{AC/DC}	ohne	PUR	BK		VAA21-230.0-L/S370	8055720	8055721	8055722	
			230V _{AC/DC}	ohne	PVC	GY		VAA21-230.0-L/P00	8055726	8055727	8055728	
			230V _{AC/DC}	ohne	PVC	GY		VAA21-230.0-L/P01	8055732	8055733	8055734	







* Unsere Standardleitungslängen sind 2m, 5m oder 10m für Anschlussleitungen und 1m, 2m oder 5m für Verbindungsleitungen. Die Litzenlänge bei Flanschen beträgt 0,5m (POWER 0,2m). Alle anderen Leitungs- und Litzenlängen liefern wir Ihnen gern auf Anfrage.

		Kopf			Leitung			Artikelbezeichnung	L / L2 = Leitungslänge		
		Pole	U[max]	Beschaltung	Material	Farbe	L1[m]		2m / 1m	5m / 2m	10m / 5m
	Anschlussleitung Kupplung, Ventil AA, axial	2+PE, PE gebrückt	230V _{AC/DC}	Varistor	PUR	BK		VAA22-230.5-L/S370	8055666	8055671	8055667
			230V _{AC/DC}	Varistor	PVC	GY		VAA22-230.5-L/P00	8055690	8055691	8055692
			230V _{AC/DC}	Varistor	PVC	GY		VAA22-230.5-L/P01	8055712	8055713	8055714
			24V _{AC/DC}	ohne	PUR	BK		VAA22-24.1-L/S370	8055648	8055649	8055650
			24V _{AC/DC}	ohne	PVC	GY		VAA22-24.1-L/P00	8055672	8055673	8055674
			24V _{AC/DC}	ohne	PVC	GY		VAA22-24.1-L/P01	8055696	8055697	8055698
			24V _{AC/DC}	Transilodiode	PUR	BK		VAA22-24.3-L/S370	8055654	8055655	8055656
			24V _{AC/DC}	Transilodiode	PVC	GY		VAA22-24.3-L/P00	8055679	8055680	8055678
		24V _{AC/DC}	Transilodiode	PVC	GY		VAA22-24.3-L/P01	8055701	8055702	8055703	
		3+PE Litze	24V _{DC}	ohne	PUR	BK		VAA41-24.2-L/S370	8055660	8055661	8055662
24V _{DC}	ohne		PVC	GY		VAA41-24.2-L/P00	8055685	8055686	8055684		
24V _{DC}	ohne		PVC	GY		VAA41-24.2-L/P01	8055707	8055708	8055709		
	Anschlussleitung Kupplung, Ventil AAG, axial, Gewindebauform zur Schutzschlauchmontag	2+PE	230V _{AC/DC}	ohne	PUR	BK		VAAG21-230.0-L/S370	8055723	8055724	8055725
			230V _{AC/DC}	ohne	PVC	GY		VAAG21-230.0-L/P00	8055729	8055730	8055731
			230V _{AC/DC}	ohne	PVC	GY		VAAG21-230.0-L/P01	8055735	8055736	8055737
		2+PE, PE gebrückt	230V _{AC/DC}	Varistor	PUR	BK		VAAG22-230.5-L/S370	8055668	8055669	8055670
			230V _{AC/DC}	Varistor	PVC	GY		VAAG22-230.5-L/P00	8055693	8055694	8055695
			230V _{AC/DC}	Varistor	PVC	GY		VAAG22-230.5-L/P01	8055715	8055716	8055717
			24V _{AC/DC}	ohne	PUR	BK		VAAG22-24.1-L/S370	8055651	8055652	8055653
			24V _{AC/DC}	ohne	PVC	GY		VAAG22-24.1-L/P00	8055677	8055675	8055676
			24V _{AC/DC}	ohne	PVC	GY		VAAG22-24.1-L/P01	8055699	8055700	8055718
			24V _{AC/DC}	Transilodiode	PUR	BK		VAAG22-24.3-L/S370	8055657	8055658	8055659
24V _{AC/DC}	Transilodiode	PVC	GY		VAAG22-24.3-L/P00	8055682	8055683	8055681			
24V _{AC/DC}	Transilodiode	PVC	GY		VAAG22-24.3-L/P01	8055704	8055705	8055706			
3+PE Litze	24V _{DC}	ohne	PUR	BK		VAAG41-24.2-L/S370	8055663	8055664	8055665		
	24V _{DC}	ohne	PVC	GY		VAAG41-24.2-L/P00	8055688	8055689	8055687		
	24V _{DC}	ohne	PVC	GY		VAAG41-24.2-L/P01	8055719	8055710	8055711		
	Anschlussleitung Kupplung, Ventil A, gewinkelt Kupplung, Ventil D, gewinkelt	2+PE, PE gebrückt	24V _{AC/DC}	Transilodiode	PUR	BK	0,15	VA22-24.3-0,15-DA22-24.3-L/S370	8055743	8055744	8055745
			24V _{AC/DC}	Transilodiode	PUR	BK	0,40	VA22-24.3-0,4-DA22-24.3-L/S370	8055746	8055747	8055748
			24V _{AC/DC}	Transilodiode	PVC	GY	0,15	VA22-24.3-0,15-DA22-24.3-L/P00	8055749	8055750	8055751
			24V _{AC/DC}	Transilodiode	PVC	GY	0,15	VA22-24.3-0,15-DA22-24.3-L/P01	8055755	8055756	8055757
			24V _{AC/DC}	Transilodiode	PVC	GY	0,40	VA22-24.3-0,4-DA22-24.3-L/P00	8055752	8055753	8055754
			24V _{AC/DC}	Transilodiode	PVC	GY	0,40	VA22-24.3-0,4-DA22-24.3-L/P01	8055758	8055759	8055760







* Unsere Standardleitungslängen sind 2m, 5m oder 10m für Anschlussleitungen und 1m, 2m oder 5m für Verbindungsleitungen. Die Litzenlänge bei Flanschen beträgt 0,5m (POWER 0,2m). Alle anderen Leitungs- und Litzenlängen liefern wir Ihnen gern auf Anfrage.

		Pole	Kopf		Leitung			Artikelbezeichnung	L /L2 = Leitungslänge					
			U[<i>max</i>]	Beschaltung	Material	Farbe	L1[m]		2m / 1m	5m / 2m	10m / 5m			
	Anschlussleitung Kupplung, Ventil A, gewinkelt Kupplung, Ventil D, gewinkelt M12x1, 5-polig	2+PE, PE gebrückt	24V _{AC/DC}	Transildiode	PUR	BK	0,15	VA22-24.3-0,15-DA22-24.3-WAS5.132/S370	8055761					
			24V _{AC/DC}	Transildiode	PUR	BK	0,40	VA22-24.3-0,4-DA22-24.3-WAS5.132/S370	8055762					
			24V _{AC/DC}	Transildiode	PVC	GY	0,15	VA22-24.3-0,15-DA22-24.3-WAS5.132/P00	8055763					
			24V _{AC/DC}	Transildiode	PVC	GY	0,15	VA22-24.3-0,15-DA22-24.3-WAS5.132/P01	8055765					
			24V _{AC/DC}	Transildiode	PVC	GY	0,40	VA22-24.3-0,4-DA22-24.3-WAS5.132/P00	8055764					
			24V _{AC/DC}	Transildiode	PVC	GY	0,40	VA22-24.3-0,4-DA22-24.3-WAS5.132/P01	8055766					
	Anschlussleitung Kupplung, Ventil B, gewinkelt	2+PE	230V _{AC/DC}	ohne	PUR	BK		VB21-230.0-L/S370	8050760	8047809	8050761			
			230V _{AC/DC}	ohne	PVC	GY		VB21-230.0-L/P00	8048842	8048843	8050834			
			230V _{AC/DC}	ohne	PVC	GY		VB21-230.0-L/P01	8050881	8047827	8050882			
			230V _{AC/DC}	Varistor	PUR	BK		VB21-230.5-L/S370	8050762	8047810	8050763			
			230V _{AC/DC}	Varistor	PVC	GY		VB21-230.5-L/P00	8050835	8049312	8050836			
			230V _{AC/DC}	Varistor	PVC	GY		VB21-230.5-L/P01	8050883	8047828	8050884			
			24V _{AC/DC}	ohne	PUR	BK		VB21-24.1-L/S370	8049246	8047807	8050757			
			24V _{AC/DC}	ohne	PVC	GY		VB21-24.1-L/P00	8050829	8049311	8050830			
			24V _{AC/DC}	ohne	PVC	GY		VB21-24.1-L/P01	8050877	8047825	8050878			
			24V _{AC/DC}	Transildiode	PUR	BK		VB21-24.3-L/S370	8050758	8047808	8050759			
			24V _{AC/DC}	Transildiode	PVC	GY		VB21-24.3-L/P00	8048844	8048845	8050832			
			24V _{AC/DC}	Transildiode	PVC	GY		VB21-24.3-L/P01	8050879	8047826	8050880			
				Anschlussleitung Kupplung, Ventil BI, gewinkelt	2+PE	230V _{AC/DC}	ohne	PUR	BK		VBI21-230.0-L/S370	8050766	8047813	8049931
						230V _{AC/DC}	ohne	PVC	GY		VBI21-230.0-L/P00	8050857	8049314	8050858
230V _{AC/DC}	ohne	PVC				GY		VBI21-230.0-L/P01	8050904	8047831	8050905			
230V _{AC/DC}	Varistor	PUR				BK		VBI21-230.5-L/S370	8050767	8047814	8050768			
230V _{AC/DC}	Varistor	PVC				GY		VBI21-230.5-L/P00	8050859	8048821	8050860			
230V _{AC/DC}	Varistor	PVC				GY		VBI21-230.5-L/P01	8050906	8047832	8050907			
24V _{AC/DC}	ohne	PUR				BK		VBI21-24.1-L/S370	8050764	8047811	8050539			
24V _{AC/DC}	ohne	PVC				GY		VBI21-24.1-L/P00	8050838	8049313	8050538			
24V _{AC/DC}	ohne	PVC				GY		VBI21-24.1-L/P01	8050899	8047829	8050900			
24V _{AC/DC}	Transildiode	PUR				BK		VBI21-24.3-L/S370	8049884	8047812	8050765			
24V _{AC/DC}	Transildiode	PVC				GY		VBI21-24.3-L/P00	8050855	8048820	8050856			
24V _{AC/DC}	Transildiode	PVC				GY		VBI21-24.3-L/P01	8050901	8047830	8050902			
	Anschlussleitung Kupplung, Ventil C, gewinkelt	2+PE				230V _{AC/DC}	ohne	PUR	BK		VC21-230.0-L/S370	8050772	8047817	8050773
						230V _{AC/DC}	ohne	PVC	GY		VC21-230.0-L/P00	8050846	8049317	8050848
			230V _{AC/DC}	ohne	PVC	GY		VC21-230.0-L/P01	8050914	8047835	8050916			







* Unsere Standardleitungslängen sind 2m, 5m oder 10m für Anschlussleitungen und 1m, 2m oder 5m für Verbindungsleitungen. Die Litzenlänge bei Flanschen beträgt 0,5m (POWER 0,2m). Alle anderen Leitungs- und Litzenlängen liefern wir Ihnen gern auf Anfrage.



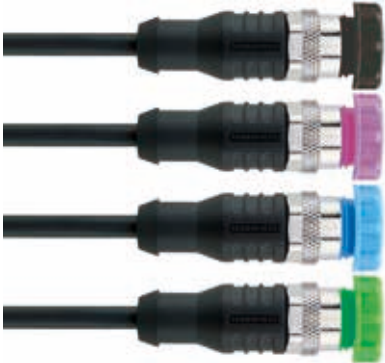
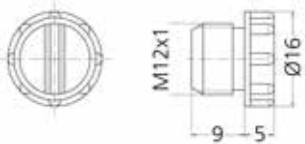
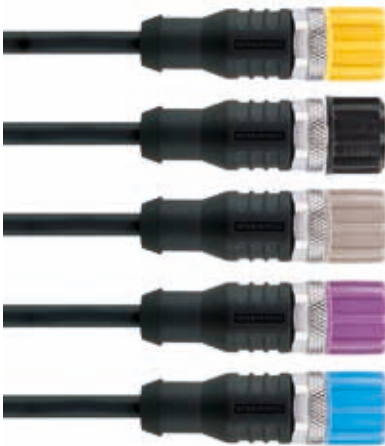
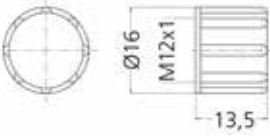

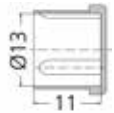

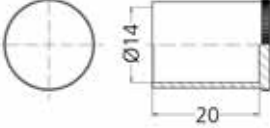

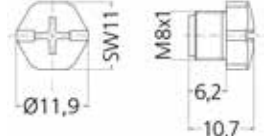

		Pole	Kopf		Leitung			Artikelbezeichnung	L / L2 = Leitungslänge		
			U[max]	Beschaltung	Material	Farbe	L1[m]		2m / 1m	5m / 2m	10m / 5m
	Anschlussleitung Kupplung, Ventil C, gewinkelt	2+PE, PE gebrückt	24V _{AC/DC}	ohne	PUR	BK	VC22-24.1-L/S370	8050769	8047815	8050770	
			24V _{AC/DC}	ohne	PVC	GY	VC22-24.1-L/P00	8050842	8049315	8050843	
			24V _{AC/DC}	ohne	PVC	GY	VC22-24.1-L/P01	8050909	8047833	8050910	
			24V _{AC/DC}	Z-Diode	PUR	BK	VC22-24.4-L/S370	8049873	8047816	8050771	
			24V _{AC/DC}	Z-Diode	PVC	GY	VC22-24.4-L/P00	8050844	8049316	8050845	
			24V _{AC/DC}	Z-Diode	PVC	GY	VC22-24.4-L/P01	8050912	8047834	8050913	
	Anschlussleitung Kupplung, Ventil CI, gewinkelt	2+PE	230V _{AC/DC}	ohne	PUR	BK	VCI21-230.0-L/S370	8050778	8047820	8050779	
			230V _{AC/DC}	ohne	PVC	GY	VCI21-230.0-L/P00	8050853	8049320	8050854	
			230V _{AC/DC}	ohne	PVC	GY	VCI21-230.0-L/P01	8050921	8047838	8050922	
		2+PE, PE gebrückt	24V _{AC/DC}	ohne	PUR	BK	VCI22-24.1-L/S370	8050774	8047818	8050775	
			24V _{AC/DC}	ohne	PVC	GY	VCI22-24.1-L/P00	8050849	8049318	8050850	
			24V _{AC/DC}	ohne	PVC	GY	VCI22-24.1-L/P01	8050917	8047836	8050918	
			24V _{AC/DC}	Z-Diode	PUR	BK	VCI22-24.4-L/S370	8050776	8047819	8050777	
			24V _{AC/DC}	Z-Diode	PVC	GY	VCI22-24.4-L/P00	8050851	8049319	8050852	
			24V _{AC/DC}	Z-Diode	PVC	GY	VCI22-24.4-L/P01	8050919	8047837	8050920	
				Verbindungsleitung Kupplung, Ventil A, gewinkelt Stecker, M12x1, axial	2+PE, PE gebrückt	24V _{AC/DC}	Transildiode	PUR	BK	VA22-24.3-L-AL-WAS5.002/S370	8052049
24V _{AC/DC}	Transildiode	PVC				GY	VA22-24.3-L-AL-WAS5.002/P00	8052209	8052225	8052226	
24V _{AC/DC}	Transildiode	PVC				GY	VA22-24.3-L-AL-WAS5.002/P01	8052260	8052261	8052262	
3+PE Litze	24V _{DC}	ohne			PUR	BK	VA41-24.2-L-AL-WAS5/S370	8052051	8050785	8050786	
	24V _{DC}	ohne			PVC	GY	VA41-24.2-L-AL-WAS5/P00	8052230	8052231	8052232	
	24V _{DC}	ohne			PVC	GY	VA41-24.2-L-AL-WAS5/P01	8052266	8052267	8052268	
	Verbindungsleitung Kupplung, Ventil A, gewinkelt Stecker, M12x1, gewinkelt	2+PE, PE gebrückt	24V _{AC/DC}	Transildiode	PUR	BK	VA22-24.3-L-AL-WWAS5.002/S370	8052050	8050780	8050186	
			24V _{AC/DC}	Transildiode	PVC	GY	VA22-24.3-L-AL-WWAS5.002/P00	8052227	8052228	8052229	
			24V _{AC/DC}	Transildiode	PVC	GY	VA22-24.3-L-AL-WWAS5.002/P01	8052263	8052264	8052265	
		3+PE Litze	24V _{DC}	ohne	PUR	BK	VA41-24.2-L-AL-WWAS5/S370	8052052	8050788	8050188	
			24V _{DC}	ohne	PVC	GY	VA41-24.2-L-AL-WWAS5/P00	8052233	8052234	8052235	
			24V _{DC}	ohne	PVC	GY	VA41-24.2-L-AL-WWAS5/P01	8052269	8052270	8052271	
	Verbindungsleitung Kupplung, Ventil B, gewinkelt Stecker, M12x1, axial	2+PE	24V _{AC/DC}	Transildiode	PUR	BK	VB21-24.3-L-AL-WAS5.002/S370	8052053	8050790	8050791	
			24V _{AC/DC}	Transildiode	PVC	GY	VB21-24.3-L-AL-WAS5.002/P00	8052236	8052237	8052238	
			24V _{AC/DC}	Transildiode	PVC	GY	VB21-24.3-L-AL-WAS5.002/P01	8052272	8052273	8052274	
	Verbindungsleitung Kupplung, Ventil B, gewinkelt Stecker, M12x1, gewinkelt	2+PE	24V _{AC/DC}	Transildiode	PUR	BK	VB21-24.3-L-AL-WWAS5.002/S370	8052054	8050797	8050189	
			24V _{AC/DC}	Transildiode	PVC	GY	VB21-24.3-L-AL-WWAS5.002/P00	8052239	8052240	8052241	
			24V _{AC/DC}	Transildiode	PVC	GY	VB21-24.3-L-AL-WWAS5.002/P01	8052275	8052276	8052277	



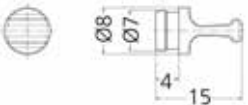

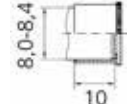

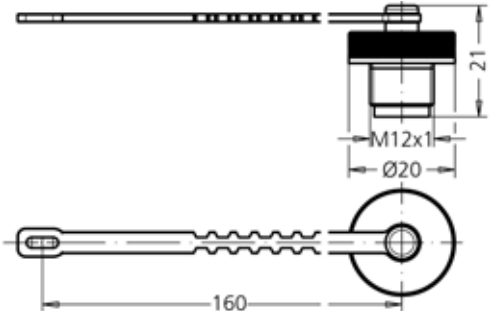

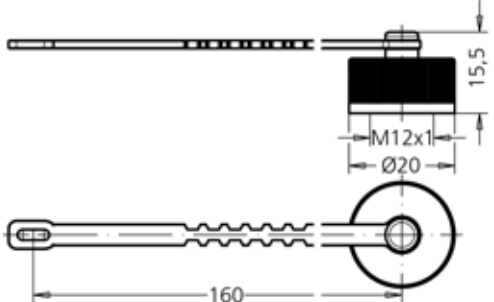
* Unsere Standardleitungslängen sind 2m, 5m oder 10m für Anschlussleitungen und 1m, 2m oder 5m für Verbindungsleitungen. Die Litzenlänge bei Flanschen beträgt 0,5m (POWER 0,2m). Alle anderen Leitungs- und Litzenlängen liefern wir Ihnen gern auf Anfrage.

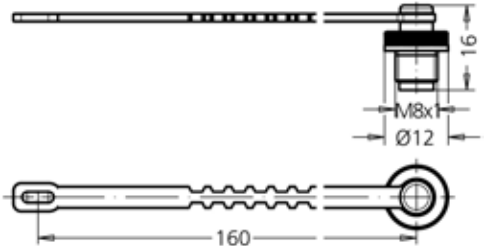

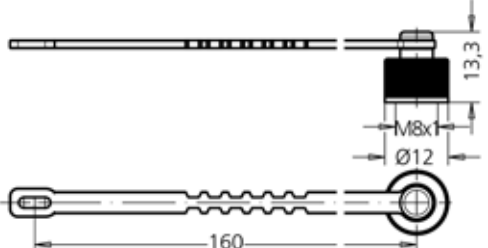

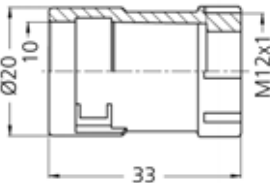

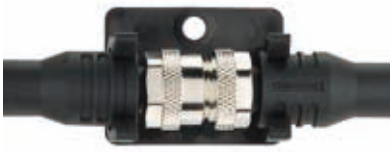
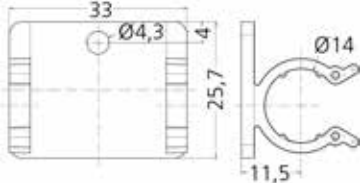
		Pole	Kopf		Leitung			Artikelbezeichnung	L / L2 = Leitungslänge					
			U[max]	Beschaltung	Material	Farbe	L1[m]		2m / 1m	5m / 2m	10m / 5m			
	Verbindungsleitung Kupplung, Ventil BI, gewinkelt Stecker, M12x1, axial	2+PE	24V _{AC/DC}	Transildiode	PUR	BK	VBI21-24.3-L-AL-WAS5.002/S370	8049278	8050800	8050801				
			24V _{AC/DC}	Transildiode	PVC	GY					VBI21-24.3-L-AL-WAS5.002/P00	8052242	8052243	8052244
			24V _{AC/DC}	Transildiode	PVC	GY					VBI21-24.3-L-AL-WAS5.002/P01	8052278	8052279	8052280
	Verbindungsleitung Kupplung, Ventil BI, gewinkelt Stecker, M12x1, gewinkelt	2+PE	24V _{AC/DC}	Transildiode	PUR	BK	VBI21-24.3-L-AL-WWAS5.002/S370	8049279	8050804	8050805				
			24V _{AC/DC}	Transildiode	PVC	GY					VBI21-24.3-L-AL-WWAS5.002/P00	8052245	8052246	8052247
			24V _{AC/DC}	Transildiode	PVC	GY					VBI21-24.3-L-AL-WWAS5.002/P01	8052281	8052282	8052283
	Verbindungsleitung Kupplung, Ventil C, gewinkelt Stecker, M12x1, axial	2+PE, PE gebrückt	24V _{AC/DC}	Z-Diode	PUR	BK	VC22-24.4-L-AL-WAS5.002/S370	8052055	8050807	8050190				
			24V _{AC/DC}	Z-Diode	PVC	GY					VC22-24.4-L-AL-WAS5.002/P00	8052248	8052249	8052250
			24V _{AC/DC}	Z-Diode	PVC	GY					VC22-24.4-L-AL-WAS5.002/P01	8052284	8052285	8052286
	Verbindungsleitung Kupplung, Ventil C, gewinkelt Stecker, M12x1, gewinkelt	2+PE, PE gebrückt	24V _{AC/DC}	Z-Diode	PUR	BK	VC22-24.4-L-AL-WWAS5.002/S370	8052056	8050813	8050191				
			24V _{AC/DC}	Z-Diode	PVC	GY					VC22-24.4-L-AL-WWAS5.002/P00	8052251	8052252	8052253
			24V _{AC/DC}	Z-Diode	PVC	GY					VC22-24.4-L-AL-WWAS5.002/P01	8052287	8052288	8052289
	Verbindungsleitung Kupplung, Ventil CI, gewinkelt Stecker, M12x1, axial	2+PE, PE gebrückt	24V _{AC/DC}	Z-Diode	PUR	BK	VCI22-24.4-L-AL-WAS5.002/S370	8052057	8050810	8050192				
			24V _{AC/DC}	Z-Diode	PVC	GY					VCI22-24.4-L-AL-WAS5.002/P00	8052254	8052255	8052256
			24V _{AC/DC}	Z-Diode	PVC	GY					VCI22-24.4-L-AL-WAS5.002/P01	8052290	8052291	8052292
	Verbindungsleitung Kupplung, Ventil CI, gewinkelt Stecker, M12x1, gewinkelt	2+PE, PE gebrückt	24V _{AC/DC}	Z-Diode	PUR	BK	VCI22-24.4-L-AL-WWAS5.002/S370	8052058	8050816	8050193				
			24V _{AC/DC}	Z-Diode	PVC	GY					VCI22-24.4-L-AL-WWAS5.002/P00	8052257	8052258	8052259
			24V _{AC/DC}	Z-Diode	PVC	GY					VCI22-24.4-L-AL-WWAS5.002/P01	8052293	8052294	8052296
	Adapter Stecker, Ventil A, gewinkelt Anschlussstecker M12x1, 5-polig	2+PE, PE gebrückt	24V _{AC/DC}	ohne			VA22-24.1-WAS5.002	8055767						
			24V _{AC/DC}	Transildiode			VA22-24.3-WAS5.002	8055768						
			24V _{DC}	ohne			VA41-24.2-WAS5	8055769						
			60V _{AC/DC}	ohne			VA22-60.0-WAS5.002	8055770						

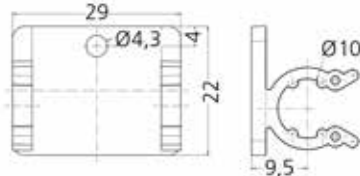

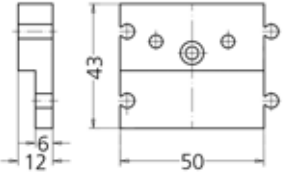

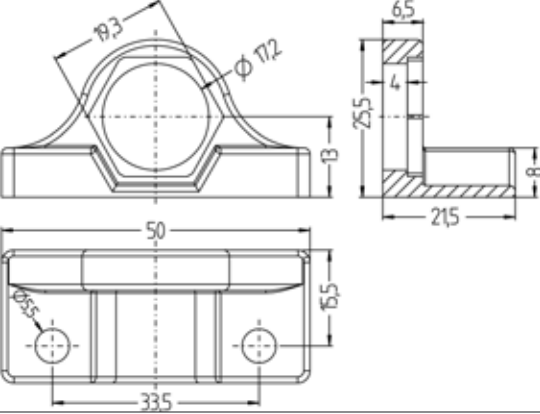

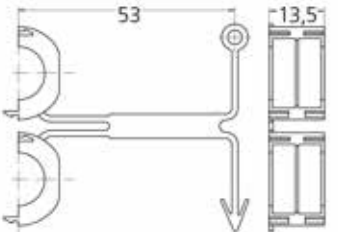

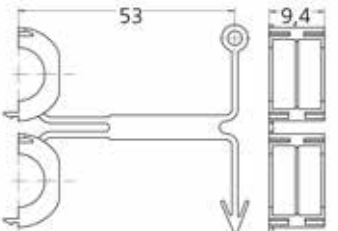

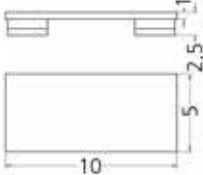

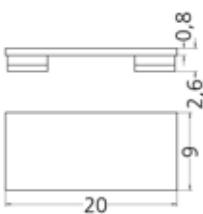
* Unsere Standardleitungslängen sind 2m, 5m oder 10m für Anschlussleitungen und 1m, 2m oder 5m für Verbindungsleitungen. Die Litzenlänge bei Flanschen beträgt 0,5m (POWER 0,2m). Alle anderen Leitungs- und Litzenlängen liefern wir Ihnen gern auf Anfrage.

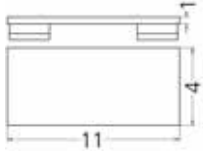

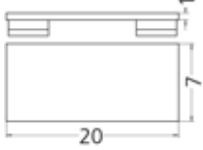



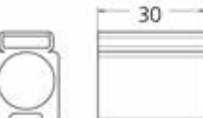

				Verpackungseinheit Art-Nr.				
				Material Farbe	1	10	100	500
		Schutzstopfen Abdeckung für M12x1 Kupplung	BK, ähnlich RAL9005	8000004		8081767	8081768	
			VT, ähnlich RAL4001	8041992		8081773	8081774	
			BU, ähnlich RAL5012	8041993		8081775	8081776	
			GN, ähnlich RAL6018	8059233		8081777	8081778	
		Schutzkappe Abdeckung für M12x1 Stecker	YE, ähnlich RAL1021	8000031		8081751	8081752	
			BK, ähnlich RAL9005	8036742		8081753	8081754	
			GY, ähnlich RAL7035	8041994		8081755	8081756	
			VT, ähnlich RAL4001	8041995		8081757	8081758	
			BU, ähnlich RAL5012	8041996		8081759	8081760	
		Staubschutzkappe Abdeckung für M12x1 Stecker	transparent	8009778		8081749	8081750	
		Staubschutzkappe Abdeckung für M12x1 Kupplung/Stecker	BK, ähnlich RAL9005	8043617		8081763	8081764	
		Schutzstopfen Abdeckung für M8x1 Kupplung	BK, ähnlich RAL9005	8015075		8081771	8081772	







				Verpackungseinheit Art-Nr.				
				Material Farbe	1	10	100	500
		Schutzkappe Abdeckung für M8x1 Stecker	BK, ähnlich RAL9005	8041582			8081761	8081762
		Schutzkappe Abdeckung für RJ45	Kunststoff transparent	8064715				
		Schutzstopfen Abdeckung für Ø 8mm snap Kupplung	BK, ähnlich RAL9005	8010971			8081769	8081770
		Schutzkappe Abdeckung für Ø 8mm snap Kupplung/Stecker	TPE YE, ähnlich RAL1018	8067188			8081765	8081766
		Schutzstopfen unverlierbar Abdeckung für M12x1 Kupplung	BK, ähnlich RAL9005	8048568				
		Schutzkappe unverlierbar Abdeckung für M12x1 Stecker	BK, ähnlich RAL9005	8048569				

				Verpackungseinheit Art-Nr.				
				Material Farbe	1	5	10	100
		Schutzstopfen unverlierbar Abdeckung für M8x1 Kupplung	BK, ähnlich RAL9005	8048567				
		Schutzkappe unverlierbar Abdeckung für M8x1 Stecker		8048566				
		Adapterstück M12x1	BK, ähnlich RAL9005	8081747				
		Schutzschlauch 50m	BK, ähnlich RAL9005	8081621				
		Befestigungsclip M12x1	POM	8047660				
		Befestigungsset M12x1 Clip + Schraube M4x8	POM	8047664				
		Befestigungsclip M8x1	POM	8047658				
		Befestigungsset M8x1 Clip + Schraube M4x8	POM	8047663				

				Verpackungseinheit Art-Nr.				
				Material Farbe	1	10	100	500
		Befestigungsset S89 2x Grundplatte + 4x Schraube M4x25 + 4x Mutter M4	PA, BK	8036078				
		Befestigungswinkel für Industrial Ethernet Adapter Für Art.-Nr. 8065952, 8065950 und 8065951	Kunststoff	8065953				
		Sicherungsclip M12x1 gegen versehentliches Trennen unter Last	PA BK, ähnlich RAL9005	8040501				
		Sicherungsclip M8x1 gegen versehentliches Trennen unter Last	PA BK, ähnlich RAL9005	8040691				

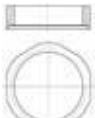
				Verpackungseinheit Art-Nr.				
				Material Farbe	1	10	100	500
		Bezeichnungsschilder I/O Verteiler M8x1					8011349	
		Bezeichnungsschilder I/O Verteiler M12x1		WH, ähnlich RAL9002			8015002	
		Bezeichnungsschilder Ventilsteckverbinder AA, B, BI, C, CI		WH, ähnlich RAL9002			8047109	
		Bezeichnungsschilder Ventilsteckverbinder A		WH, ähnlich RAL9002			8047110	
		Bezeichnungsschildträger Ø 3,5...6,0 mm		PVC		8000052		
		Bezeichnungsschildträger Ø 6,0...10,0 mm		PVC		8000060		
		Bezeichnungsschildträger Ø 3,5...6,0 mm		thermoplastisches ESC (halogenfrei)		8000091		
		Bezeichnungsschildträger Ø 6,0...9,0 mm		thermoplastisches ESC (halogenfrei)		8000092		
		Kabel-Entmanteler Zum Auftrennen des Außenmantels PUR-ummantelter Kabel durch Längsschnitt.				8066217		

				Verpackungseinheit Art-Nr.				
				Material Farbe	1	10	100	500
		Abmantelzange 4,40 - 7,00mm für Sensor-/Aktor-, hochflexible TPE-U-, PUR-, PUR/ PVC, PVC, geschirmte und ungeschirmte Leitungen mit mehrdrigem Kabelaufbau.			8066215			
		Abmantelzange 3,20 - 4,40mm für Sensor-/Aktor-, hochflexible TPE-U-, PUR-, PUR/ PVC, PVC, geschirmte und ungeschirmte Leitungen mit mehrdrigem Kabelaufbau.			8066216			
		Edelstahlschraube für Ventilsteckverbinder Bauform A, B, BI SW 10		V4A	8060907			
		Ersatzmutter Für Flansch M8x1 PFKS,PFS SW10		Metall, CuZn, vernickelt	8004923			
		Ersatzmutter Für Flansch M8x1 PFSF SW10		Metall, CuZn, vernickelt	8004971			
		Ersatzmutter Für Flansch M12x1 FSF SW16		Metall, CuZn, vernickelt	8004930			
		Ersatzmutter Für Flansch M12x1 FKD, FSD PG9 SW17		Metall, CuZn, vernickelt	8004874			
		Ersatzmutter Für Flansch M12x1 FKD, FSD M16 SW17		Metall, CuZn, vernickelt	8027491			

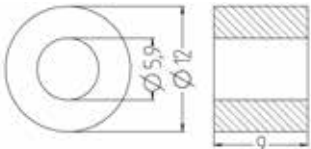
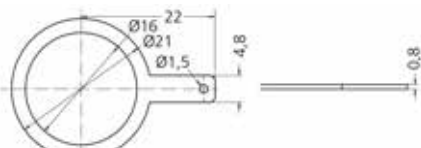
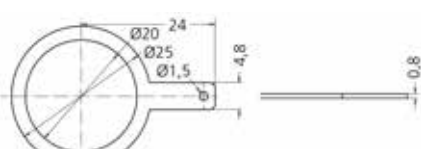
				Verpackungseinheit Art-Nr.				
				Material Farbe	1	10	100	500
			Ersatzmutter Für Flansch M12x1 PG9 SW18	Metall, CuZn, vernickelt	8004913			
			Ersatzmutter Für Flansch M12x1 M16x1,5 SW19	Metall, CuZn, vernickelt	8029359			
			Ersatzmutter Für Flansch M12x1 FKD, FSD, M20 SW22	Metall, CuZn, vernickelt	8027492			
			Ersatzmutter Für Flansch M12x1 M20x1,5 SW24	Metall, CuZn, vernickelt	8029360			
			Dichtung für selbstkonfektionierbare Steckverbinder, M12x1	BK, ähnlich RAL9005	8061922			
			Lötöse M16x1,5 zur Erdung von Flanschgehäusen	Metall, CuZn, vernickelt	8036043			
			Lötösen M20x1,5 zur Erdung von Flanschgehäusen	Metall, CuZn, vernickelt	8036044			

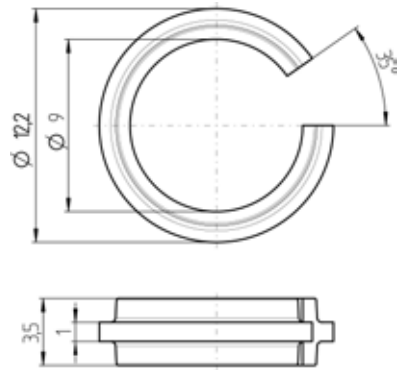

Kennzeichnungsringe Ø 9mm zur farblichen Kennzeichnung von Leitungen und Steckverbindern (M12x1, M12x1 geschirmt, RJ45, Flansch umspritzt mit Leitung FKFDYSY, M8x1 geschirmt)

Material Farbe	Verpackungseinheit Art-Nr.			
	1	10	100	500
POM WH, ähnlich RAL9002			8063523	
POM RD, ähnlich RAL3020			8063524	
POM BU, ähnlich RAL5012			8063525	
POM YE, ähnlich RAL1018			8063526	
POM GN, ähnlich RAL6018			8063527	
POM BK, ähnlich RAL9004			8063528	
POM OG, ähnlich RAL2008			8063529	
POM VT, ähnlich RAL4006			8063530	
POM GY, ähnlich RAL7035			8063531	
POM PK, ähnlich RAL4003			8063532	
POM ähnlich RAL1002			8063533	

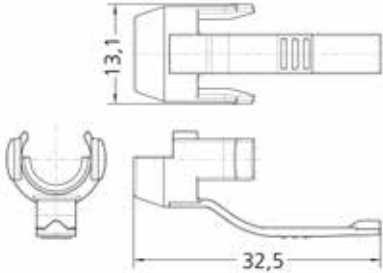
				Verpackungseinheit Art-Nr.				
				Material Farbe	1	10	100	500
		Entriegelungsclips für RJ45		POM RD, ähnlich RAL3020	8071939			
				POM OG, ähnlich RAL2008	8071944			
				POM YE, ähnlich RAL1018	8071941			
				POM ähnlich RAL1002	8071948			
				POM GN, ähnlich RAL6018	8071942			
				POM BU, ähnlich RAL5012	8071940			
				POM VT, ähnlich RAL4006	8071945			
				POM PK, ähnlich RAL4003	8071947			
				POM GY, ähnlich RAL7035	8071946			
				POM WH, ähnlich RAL9002	8071938			
				POM BK, ähnlich RAL9004	8071943			

			Verpackungseinheit Art-Nr.				
			Material Farbe	1	10	100	500
		<p>Drehmomentschlüssel-Set in einer Rolltasche, komplett M8x1, M12x1 (für Rändel und 6-Kant)</p>		8055431			
		<p>Food & Beverage Drehmomentklinge SW14 für M12x1 (einzeln)</p>		8063392			



P00	P01® P01BK®	S370® S370GY®	S7400® robotic	S400® easystrip	S3930	S2430		
PVC	PVC	PUR, halogenfrei	PUR, halogenfrei	PUR, halogenfrei	TPE, halogenfrei	PTFE(5Y)		Mantelmaterial
PVC	PVC	PP, halogenfrei	PP, halogenfrei	PP, halogenfrei	TPE, halogenfrei	PTFE(5Y)		Isolierung
RAL 7040	RAL 7040 RAL 9005	RAL 9005 RAL 7040	RAL 2003	RAL 9005	RAL 7035	RAL 9003		Mantelfarbe (ähnlich)
★★★★	★★★★	★★★★	★★★★	★★★★	★	★		Maschinen- u. Anlagenbau
★★	★★	★★★★	★★★★	★★★★	★★★★	★★		Automobilindustrie
★	★	★★★★	★★★★	★★★★	★★★★	★★		Robotertechnik
★★★★	★★★★	★	★	★	★★★★	★★		Lebensmittelindustrie
★★★★	★★★★	★	★	★	★★★★	★★		Verpackungs- u. Abfüllanlagen
★★	★★	★★	★★	★★	★★	★★		Gebäudeinstallation
★★	★★	★★★★	★★★★	★★★★	★★	★★★★		Windkraftanlagen
★★★★	★★★★	★★★★	★★★★	★★★★	★★★★	★★★★		flammwidrig
★★	★★	★★★★	★★★★	★★★★	★★	★★★★		ölbeständig
★	★	★★★★	★★★★	★★★★	★	★★		schweißfunkenfest
★	★	★★★★	★★★★	★★★★	★★	★★		schleppkettentauglich
		★★★	★★★★	★★★★				torsionsbeständig
★	★	★	★	★	★★	★★★★		säuren- und laugenbeständig
★★	★★	★★	★★	★★	★★★★	★★★★		seewasserbeständig
★	★	★★★★	★★★★	★★★★	★★	★★★★		Ozon- und UV-beständig
★★	★★	★★	★★	★★	★★★★	★★★★		hydrolysefest
★★	★★	★★	★★	★★	★★★★	★★★★		microbenbeständig
≤300V	≤300V	≤300V	≤300V	≤300V	≤250V _{AC}	≤250V		Nennspannung
10xØ	10xØ	10xØ	10xØ	10xØ	10xØ	10xØ		Biegefestigkeit (bewegt)
5xØ	5xØ	5xØ	5xØ	5xØ	5xØ	5xØ		Biegefestigkeit (fest verlegt)
0°C...+80°C	0°C...+80°C	-30°C...+90°C	-30°C...+90°C	-30°C...+90°C	-25°C...+105°C	k.A.		Temperaturbereich (bewegt)
-25°C...+80°C	-25°C...+80°C	-40°C...+90°C	-40°C...+90°C	-40°C...+90°C	-40°C...+105°C	-190°C...+260°C		Temperaturbereich (fest verlegt)
optional	optional	optional	nein	nein	optional	optional		Schirmung
✓	✓	✓	✓	✓	✓	✓		ROHS
	✓	✓	✓	✓				UL und/oder CSA
✓	✓	✓	✓	✓	✓	✓		GOST
✓					✓			ECOLAB
AL BL FB V	AL BL V	AL BL V	AL BL	AL BL	FB	HT		ESCHA Steckverbinderfamilie

Material

typische Einsatzgebiete

Beständigkeiten



Eigenschaften

Zulassungen



	S5015® S5025®	Cat5e S2171®	Cat5 S3400®	Cat7 S3500®	S4030®(Cat7) S4031®(Cat6)	Cat5e S3800®	S1800®	S2800®
Material	PUR, halogenfrei	außen PUR11Y, innen FRNC	PUR, F45052-F5100	PUR11Y	PUR	außen PUR11Y, innen FRNC	PUR	PUR
	PP, halogenfrei	PE2Y, halogenfrei	PP	PE02Y, geschäumt	Foam-Skin Polyolefin	PE2Y, halogenfrei	PE, geschäumt	Signal: PE, Power: PP
	RAL9005	RAL6018	RAL6018	RAL6018	RAL6018	RAL3020	RAL4001	RAL9005
typische Einsatzgebiete	★★★★	★★	★	★	★★	★	★★	★★
	★★★★	★★★★	★★★★★	★★★★	★★★★	★★★★	★★★★	★★★★
	★★★★	★★	★★	★★	★★★	★★	★★	★★
	★	★	★	★	★	★	★	★
	★	★	★	★	★	★	★	★
	★★	★★★★	★★★★	★★★★	★★	★★★★	★★★★	★★★★
	★★★★	★★★★	★★★★	★★★★	★★★★	★★★★	★★★★	★★★★
Beständigkeiten	★★★★	★★★★	★★	★★★★	★★★★	★★★★	★★★★	★★★★
	★★★★	★★★★	★★★★	★★★★	★★★★	★★★★	★★	★★
	★★★★	★	★	★	★	★	★	★
	★★★★	★★★★	★★★★		★ (S4030) ★★★★★ (S4031)	★★★★	★★	★
	★	★	★	★	★★★★ (S4030) ★ (S4031)	★	★	★
	★★							
	★★	★★	★★	★★	★★	★★	★★	★★
	★★★★	★★	★★	★★	★★	★★	★★	★★★★
	★★	★★	★★	★★	★★	★★	★★	★★
★★	★★	★★	★★	★★	★★	★★	★★	
Eigenschaften	VDE U ₀ /U: 600V/1.000V	600V (UL rating)	30V (UL rating)	30V (UL rating)	125V 100V	600V (UL rating)	300V	≤300V
	7,5xØ 10xØ	8xØ	7,5xØ	10xØ	15xØ 7,5xØ	8xØ	10xØ	10xØ
	4 xØ	4xØ	4xØ	5xØ	8xØ 4xØ	4xØ	5xØ	5xØ
	-40°C...+90°C	-30°C...+70°C	-40°C...+80°C	-40°C...+80°C	-30°C...+70°C	-40°C...+80°C	-25°C...+80°C	-25°C...+80°C
	-50°C...+90°C	-40°C...+75°C	-40°C...+80°C	-20°C...+60°C	-40°C...+80°C	-40°C...+80°C	-50°C...+80°C	-50°C...+80°C
	nein	ja	ja	ja	ja	ja	ja	ja
Zulassungen	✓	✓	✓	✓	✓	✓	✓	✓
	✓	✓	✓	✓	✓	✓	✓	✓
	✓	✓	✓	✓	✓	✓	✓	✓
	POWER	IE Profinet	IE EtherCat	Industrial Ethernet	Industrial Ethernet	IE Sercos®	Profibus	CANopen/DeviceNet

	Adern	Adernfarben	Litzenaufbau	ø [mm]	Artikelbezeichnung	L=100m
	3	BN, BU, BK	32 x 0,10 mm	4,60	LiF9Y11YFHF 3x0,25 mm ²	8058484
	4	BN, WH, BU, BK	32 x 0,10 mm	4,80	LiF9YH-11YH 4x0,25 (32x0,10)	8069722
	3	BN, BU, BK	42 x 0,10 mm	4,80	LiF9Y11YFHF 3x0,34 mm ²	8058485
	4	BN, WH, BU, BK	42 x 0,10 mm	5,20	LiF9Y11YFHF 4x0,34 mm ²	8057309
	4+PE	BN, WH, BU, BK, GN/YE	42 x 0,10 mm	5,60	LiF9Y11YFHF 4x0,34+1x0,34 mm ²	8058487
	3	BN, BU, BK	42 x 0,10 mm	4,00	LiF9YH-11YH 3x0,25	8058490
	4	BN, WH, BU, BK	42 x 0,10 mm	4,30	LiF9YH-11YH 4x0,25	8058491
	5	BN, WH, BU, BK, GY	14 x 0,15 mm	4,50	LiF9YH-11YH 5x0,25	8058492
	3	BN, BU, BK	42 x 0,10 mm	4,30	LiF9YH-11YH 3x0,34	8046603
	4	BN, WH, BU, BK	42 x 0,10 mm	4,70	LiF9YH-11YH 4x0,34	8045519
	4+PE	BN, WH, BU, BK, GN/YE	42 x 0,10 mm	5,20	LiF9YH-11YH 4x0,34+1x0,34	8048725
	5	BN, WH, BU, BK, GY	42 x 0,10 mm	5,20	LiF9YH-11YH 5x0,34	8047757
	8	WH, BN, GN, YE, GY, PK, BU, RD	32 x 0,10 mm	5,90	LiF9YH11YH 8x0,25	8055605
	12	BN, BU, WH, GN, PK, YE, BK, GY, RD, VT, GY/PK, RD/BU	18 x 0,10 mm	5,60	LiFYY 12 x 0,14 mm ²	8055606
	3	BN, BU, BK	42 x 0,10 mm	4,00	LiF9YH-11YH 3x0,25	8058493
	4	BN, WH, BU, BK	32 x 0,10 mm	4,30	LiF9YH-11YH 4x0,25 (32x0,10)	8079702
	3	BN, BU, BK	42 x 0,10 mm	4,30	LiF9YH-11YH 3x0,34	8058494
	4	BN, WH, BU, BK	42 x 0,10 mm	4,70	LiF9YH-11YH 4x0,34	8058495
	4+PE	BN, WH, BU, BK, GN/YE	42 x 0,10 mm	5,20	LiF9YH-11YH 4x0,34+1x0,34	8058496
	3	BN, BU, BK	42 x 0,10 mm	4,80	LiF9YC11YFHF 3x0,34	8058488
	4	BN, WH, BU, BK	42 x 0,10 mm	5,10	LiF9YC11YFHF 4x0,34	8047431
	5	BN, WH, BU, BK, GY	42 x 0,10 mm	5,60	LiF9YC11YFHF sw 5x0,34	8046513
	8	WH, BN, GN, YE, GY, PK, BU, RD	32 x 0,10 mm	6,30	LiF9YHC11YH 8x0,25	8048963
	12	BN, BU, WH, GN, PK, YE, BK, GY, RD, VT, GY/PK, RD/BU	18 x 0,10 mm	6,00	Li9YHC11YH 12x0,14	8058489
	3	BN, BU, BK	14 x 0,15 mm	4,00	LiYY-OB 3x0,25 (14x0,15)	8058513
	4	BN, WH, BU, BK	14 x 0,15 mm	4,20	LiYY-OB 4x0,25 (14x0,15)	8056855
	5	BN, WH, BU, BK, GY	14 x 0,15 mm	4,50	LiYY-OB 5x0,25 (14x0,15)	8058514
	3	BN, BU, BK	19 x 0,15 mm	4,20	LiYY-OB 3x0,34 (19x0,15)	8058515
	4	BN, WH, BU, BK	19 x 0,15 mm	4,50	LiYY-OB 4x0,34 (19x0,15)	8057030
	4+PE	BN, WH, BU, BK, GN/YE	19 x 0,15 mm	4,90	LiYY-JB 4x0,34+1x0,34 (19x0,15)	8058516
	5	BN, WH, BU, BK, GY	19 x 0,15 mm	4,90	LiYY-OB 5x0,34 (19x0,15)	8058517
	8	WH, BN, GN, YE, GY, PK, BU, RD	14 x 0,15 mm	5,70	LiYY-OB 8x0,25 (14x0,15)	8058519
	12	BN, BU, WH, GN, PK, YE, BK, GY, RD, VT, GY/PK, RD/BU	18 x 0,10 mm	6,10	LiYY-OB 12x0,14 (18x0,10)	8058520

	Adern	Adernfarben	Litzenaufbau	ø [mm]	Artikelbezeichnung	L=100m
	3	BN, BU, BK	14 x 0,15 mm	4,60	LiYCY-OB 3x0,25 (14x0,15)	8058497
	4	BN, WH, BU, BK	14 x 0,15 mm	4,90	LiYCY-OB 4x0,25 (14x0,15)	8058498
	5	BN, WH, BU, BK, GY	14 x 0,15 mm	5,30	LiYCY-OB 5x0,25 (14x0,15)	8058504
	3	BN, BU, BK	19 x 0,15 mm	4,80	LiYCY-OB 3x0,34 (19x0,15)	8058502
	4	BN, WH, BU, BK	19 x 0,15 mm	5,10	LiYCY-OB 4x0,34 (19x0,15)	8058503
	5	BN, WH, BU, BK, GY	19 x 0,15 mm	5,50	LiYCY-OB 5x0,34 (19x0,15)	8058504
	8	WH, BN, GN, YE, GY, PK, BU, RD	14 x 0,15 mm	6,70	LiYCY-OB 8x0,25 (14x0,15)	8042487
	12	BN, BU, WH, GN, PK, YE, BK, GY, RD, VT, GY/PK, RD/BU	18 x 0,10 mm	6,60	LiYCY-OB 12x0,14 (18x0,10)	8058505
	3	BN, BU, BK	14 x 0,15 mm	4,30	LiYY-OB 3x 0,25	8058521
	4	BN, WH, BU, BK	14 x 0,15 mm	4,70	LiYY-OB 4x0,25	8058522
	3	BN, BU, BK	19 x 0,15 mm	4,60	LiYY-OB 3x0,34mm ²	8058523
	4	BN, WH, BU, BK	19 x 0,15 mm	4,90	LiYY-OB 4x0,34mm ²	8058524
	4+PE	BN, WH, BU, BK, GN/YE	19 x 0,15 mm	5,30	LiYY-JB 4x0,34+1x0,34mm ²	8058525
	5	BN, WH, BU, BK, GY	19 x 0,15 mm	5,30	LiYY-OB 5x0,34mm ²	8058526
	8	WH, BN, GN, YE, GY, PK, BU, RD	14 x 0,15 mm	6,20	LiYY-OB 8x0,25	8058527
	12	BN, BU, WH, GN, PK, YE, BK, GY, RD, VT, GY/PK, RD/BU	18 x 0,10 mm	6,10	LiYY-OB 12x0,14	8058528
	3	BN, BU, BK	14 x 0,15 mm	4,80	LiYCY-OB 3x0,25	8058506
	4	BN, WH, BU, BK	14 x 0,15 mm	5,10	LiYCY-OB 4x0,25	8058507
	3	BN, BU, BK	19 x 0,15 mm	5,00	LiYCY-OB 3x0,34	8058508
	4	BN, WH, BU, BK	19 x 0,15 mm	5,30	LiYCY-OB 4x0,34	8058509
	5	BN, WH, BU, BK, GY	19 x 0,15 mm	5,90	LiYCY-OB 5x0,34	8058510
	8	WH, BN, GN, YE, GY, PK, BU, RD	14 x 0,15 mm	6,70	LiYCY-OB 8x0,25	8058511
	12	BN, BU, WH, GN, PK, YE, BK, GY, RD, VT, GY/PK, RD/BU	18 x 0,10 mm	6,60	LiYCY-OB 12x0,14	8058512
	3	BN, BU, BK	14 x 0,15 mm	4,30	LiYY-OB 3x0,25	8082410
	4	BN, WH, BU, BK	14 x 0,15 mm	4,70	LiYY-OB 4x0,25	8082411
	3	BN, BU, BK	19 x 0,15 mm	4,60	LiYY-OB 3x0,34	8082412
	4	BN, WH, BU, BK	19 x 0,15 mm	4,90	LiYY-OB 4x0,34	8082413
	4+PE	BN, WH, BU, BK, GN/YE	19 x 0,15 mm	5,30	LiYY-JB 4x0,34+1x0,34mm ²	8082414

	Adern	Adernfarben	Litzenaufbau	ø [mm]	Artikelbezeichnung	L=100m
	3	BN, BU, BK	32 x 0,10 mm	4,15	LiF9YH-11YH 3x0,25	8073161
	3	BN, BU, BK	42 x 0,10 mm	4,30	LiF9YH-11YH 3x0,34	8073032
	4	BN, WH, BU, BK	42 x 0,10 mm	4,40	LiF9YH-11YH 4x0,25	8073162
	4	BN, WH, BU, BK	42 x 0,10 mm	4,70	LiF9YH-11YH 4x0,34	8073033
	5	BN, WH, BU, BK, GY	32 x 0,10 mm	4,80	LiF9YH-11YH 5x0,25	8073163
	5	BN, WH, BU, BK, GY	42 x 0,10 mm	5,20	LiF9YH-11YH 5x0,34	8073164
	5	BN, WH, BU, BK, GN/YE	42 x 0,10 mm	5,20	LiF9YH-11YH 4x0,34+1x0,34	8073165
	8	WH, BN, GN, YE, GY, PK, BU, RD	32 x 0,10 mm	6,00	LiF9YH-11YH 8x0,25	8073166
	12	BN, BU, WH, GN, PK, YE, BK, GY, RD, VT, GY/PK, RD/BU	18 x 0,10 mm	5,60	LiF9YH-11YH 12x0,14	8073167
	4	BN, WH, BU, BK	42 x 0,10 mm	4,60	SU (4 Li12Y 0,34) 14Y Sarlink 3139D	8058694
	5	BN, WH, BU, BK, GY	7 x 0,254 mm	3,80	Li5Y5Y-OB 5xAWG22	8037921
	4	YE, OG, WH, BU	7 x 0,25 mm	6,50	2YH(ST)C 11Y2x2xAWG22	8036284
	8	WH/BU, BU ; WH/OG, OG ; WH/GN, GN ; WH/BN, BN	7 x 0,20 mm	9,40	ETHERLINE TORSION Cat. 7 (2170481)	8064607
	8	WH/BU, BU ; WH/OG, OG ; WH/GN, GN ; WH/BN, BN	7 x 0,20 mm	7,80	Etherline FD P CAT.6 4x2xAWG26/19 2170488	8064606
	4	BU, OG, WH/BU, WH/OG	19 x 0,10 mm	4,80	LI9YC(ST)11Y 1x4xAWG26 GN, UL-Style 20963	8055896
	8	WH/OG, OG ; WH/GN, GN ; WH/BN, BN ; WH/BU, BU	7 x 0,16 mm	6,40	LI02YSC11Y 4x2x0,14 PIMF FRNC GN Cat. 7	8053361
	4	OG, WH, BU, YE	7 x 0,254 mm	6,50	2YH(ST)C11Y 1x4xAWG22	8055782
	2	RD, GN	19 x 0,15 mm	7,60	LI02YS-STCB11Y 1x2x0,34	8043857
	4	WH, BU, RD, BK	19 x 0,13mm, 19 x 0,15mm	6,70	LIV02YS(ST)-CB11Y (2x0,25)+(2x0,34)	8047939
	2+PE	BN, BU, GN/YE	feinstdrähtig Klasse 6	8,50	LiF9YH-11YH 3G1,5	8064082
	4	BN, WH, BU, BK	feinstdrähtig Klasse 6	9,60	LiF9YH-11YH 4x1,5	8064083
	3+PE	GY, BK, BN, GN/YE	feinstdrähtig Klasse 6	9,60	LiF9YH-11YH 4G1,5	8070663
	4+PE	BU, GY, BN, BK, GN/YE	feinstdrähtig Klasse 6	9,90	PUR/PP A 5G1,5	8070850

	Adern	Adernfarben	Litzenaufbau	ø [mm]	Artikelbezeichnung	L=100m
 PUR, Steuerleitung, POWER, S5025, 2,5 mm²	4	BN, WH, BU, BK	feinstdrätig Klasse 6	11,00	LIF9YH-11YH 4x2,5	8064084
	4+PE	BU, GY, BN, BK, GN/YE	feinstdrätig Klasse 6	11,70	UR/PP A 5G2,5	8070851

TECHNISCHE INFOS

Informationen rund um den Steckverbinder

Für den Einsatz von Steckverbindern sind die jeweiligen Anforderungen der Gerätevorschriften der Anwender verbindlich. Im Folgenden werden die wesentlichen Normen und Vorschriften, nach denen unsere Produkte gefertigt und geprüft werden, erläutert.

DIN VDE 0627; 2012-03 | Steckverbinder, Steckvorrichtungen

Die Norm gilt für Steckverbinder und Steckvorrichtungen für Bemessungsspannungen bis 1000V~ bzw. 1500V- und Bemessungsströmen bis 125A je Kontakt, die in industriellen Anlagen für das Verbinden von Baugruppen oder Bauteilen in oder an Betriebsmitteln oder Mess-, Regel- oder Steuerstromkreise unter Berücksichtigung von Sicherheitsaspekten vorgesehen sind. Sie gilt auch für Steckverbinder und Steckvorrichtungen an Geräten für den Haushalt sowie Geräten der Informationsverarbeitung.

IEC 60664-1; 2008-01 | Isolationskoordination

Diese internationale Norm, die mit der deutschen Norm DIN VDE0110-1, Ausgabe April 97 übereinstimmt, ist eine Sicherheitsgrundnorm zum Erreichen der Isolationskoordination. Sie enthält die notwendigen Angaben, um Luftstrecken, Kriechstrecken und feste Isolierungen für elektrische Betriebsmittel (z.B. Steckverbinder) festzulegen. Dieses geschieht unter Berücksichtigung der Mikroumgebungsbedingungen und anderer Beanspruchungen, denen sie im Verlauf der zu erwartenden Lebensdauer voraussichtlich ausgesetzt sein werden. Eingeschlossen sind Verfahren für die Spannungsprüfung in Bezug auf die Isolationskoordination.

IEC 60512; Mai 1994 | Mess- und Prüfverfahren

Diese internationale Norm entspricht der europäischen Norm DIN EN 60512 und hat die frühere deutsche Norm DIN 41640 ersetzt. Sie legt die Mess- und Prüfverfahren für elektromechanische Bauelemente (z.B. Steckverbinder) fest. Die Norm ist sehr umfangreich und besteht aus insgesamt neun Teilen, in denen alle elektrischen, mechanischen und klimatischen Prüfungen beschrieben sind. Außerdem enthält die Norm Prüfungen über die Lötbarkeit, Dichtheit, Schirmung und Kabelabfangung.

IEC 60529; 2009-09 | Schutzarten durch Gehäuse (IP-Code)

Diese internationale Norm entspricht der europäischen Norm DIN EN60529 und stimmt mit der deutschen Norm DIN VDE 0470-1, Ausgabe November 92 überein. Sie legt die Bezeichnungen, Anforderungen und Prüfungen für die Einteilung von Schutzarten durch Gehäuse für elektrische Betriebsmittel (z.B. Steckverbinder) fest. Es wird dabei der Schutz gegen den Zugang zu gefährlichen Teilen, der Schutz gegen feste Fremdkörper und der Schutz gegen Wasser bewertet. Die Schutzart wird durch einen IP-Code bezeichnet.

IEC 60068-1; März 1995, Umweltprüfungen

Diese internationale Norm, die mit der europäischen Norm DIN EN60068-1 übereinstimmt, enthält grundlegende Festlegungen über Umweltprüfungen und Prüfschärfgrade. Diese Prüfverfahren dienen dazu, die Widerstandsfähigkeit von Bauelementen gegen erwartete Umwelteinflüsse unter Einsatzbedingungen nachzuweisen. Typische Prüfungen sind: Kälte, trockene und feuchte Wärme, Stoßen, Schwingen, Temperaturwechsel u.a.

Konstruktionsänderungen behalten wir uns aus Gründen von Qualitätsverbesserungen, Weiterentwicklung oder Fertigungsoptimierung vor. Die im Katalog genannten technischen Angaben beziehen sich auf Steckverbinder, also Bauteile, die nicht unter Spannung gesteckt und getrennt werden dürfen. Um den korrekten Einsatz der Produkte sicherzustellen werden die technischen Daten aufgeführt. Mit diesen Angaben ist es möglich die richtigen Produkte auszuwählen. Allerdings werden mit den Daten die Produkte beschrieben, die Eigenschaften jedoch nicht zugesichert. Alle ESCHA Steckverbinder sind für Einsatzbereiche im Anlagen-, Steuerungs- und Elektrogerätebau entwickelt und konstruiert worden. Die Überprüfung, ob die Steckverbinder auch in anderen Einsatzbereichen verwendet werden können, obliegt dem Anwender. Die Angaben zu Eigenschaften und Dichtigkeit beziehen sich auf Anzugsmomente von 1,0Nm für M12x1-Rundsteckverbinder bzw. 0,6Nm für M8x1-Rundsteckverbinder. Alle Angaben zu den IP-Schutzarten werden nur für die Verbindungen von ESCHA Elementen garantiert.

Kennwerte	Norm 1)	Bemerkung
Schutzart Gehäuse	IEC 60529	Angabe im gesteckten Zustand.
Mechanische Lebensdauer	IEC 60512-5/9a	Test wird ohne elektrische Belastung durchgeführt.
Bemessungsspannung	IEC 60664-1	Der angegebene Wert ist im Zusammenhang mit Verschmutzungsgrad und Überspannungskategorie definiert.
Verschmutzungsgrad	IEC 60664-1	
Strombelastbarkeit	IEC 60512-3/5b	
Durchgangswiderstand	IEC 60512-2/2a	Übergangswiderstand Kontaktstift/Kontaktbuchse im gesteckten Zustand über einen definierten Bereich.
Isolationswiderstand	IEC 60512-2/3a	Isolierung zwischen zwei leitenden Teilen (materialabhängig)

Schutzart	Kennziffer 1	Kennziffer 2
0	Nicht geschützt	Nicht geschützt
1	Geschützt gegen Zugang zu gefährlichen Teilen mit dem Handrücken. Geschützt gegen feste Fremdkörper Ø50mm.	Geschützt gegen Tropfwasser
2	Geschützt gegen Zugang zu gefährlichen Teilen mit den Fingern. Geschützt gegen feste Fremdkörper Ø12,5mm.	Geschützt gegen Tropfwasser wenn das Gehäuse bis zu 15° geneigt ist
3	Geschützt gegen Zugang zu gefährlichen Teilen mit einem Werkzeug. Geschützt gegen feste Fremdkörper Ø2,5mm.	Geschützt gegen Sprühwasser
4	Geschützt gegen Zugang zu gefährlichen Teilen mit einem Draht. Geschützt gegen feste Fremdkörper Ø1mm.	Geschützt gegen Spritzwasser
5	Geschützt gegen Zugang zu gefährlichen Teilen mit einem Draht. Staubgeschützt.	Geschützt gegen Strahlwasser
6	Geschützt gegen Zugang zu gefährlichen Teilen mit einem Draht. Staubdicht.	Geschützt gegen starkes Strahlwasser
7		Geschützt gegen die Wirkungen beim zeitweiligen Untertauchen in Wasser.
8		Geschützt gegen die Wirkungen beim dauernden Untertauchen in Wasser (Bedingungen sind zwischen Hersteller und Anwender zu vereinbaren, jedoch höher als IP_7)
9		Geschützt gegen Wasser bei Hochdruck-Dampfstrahl-Reinigung

Ergänzende technischen Daten

¹⁾ Die technischen Daten stellen Anfangswerte dar, die sich nach Beanspruchung verändern können. Bei der Montage von elektrisch leitfähigen Flanschgehäusen sind die Gehäuse mit in die Geräteschutzmaßnahmen einzubeziehen. Die anzuschließenden Leitungen sind nur soweit abzuisolieren, dass die Abstände zu elektrisch leitenden Teilen nicht verringert werden. Beim Anlöten der Leitungen ist darauf zu achten, dass keine einzelnen Adern abstehen und so Kurzschlüsse ausgelöst werden können.

Schutzarten | IP: International Protection

Aus Sicherheitsgründen müssen Steckverbinder gegen Einflüsse von außen, wie z. B. Staub, Fremdkörper, Berührung, Feuchtigkeit und Wasser geschützt werden. Dieser Schutz muss bei Industriesteckverbindern durch die Gehäuse und ihrer Verriegelung sowie der Abdichtung am Kabelabgang gewährleistet werden.

Die Schutzarten werden durch ein Kurzzeichen angegeben, das sich aus zwei stets gleichbleibenden Kennbuchstaben IP (International Protection) und zwei nachfolgenden Kennziffern für die Schutzgrade zusammensetzt. Die erste Kennziffer gibt den Schutzgrad des Berührungs- und Fremdkörperschutzes an. Die zweite Kennziffer gibt den Schutzgrad gegen schädliches Eindringen von Wasser an. Alle Angaben haben nur im verschraubten Zustand ihre Gültigkeit. Die Vergabe der Schutzarten unterliegt genormten Prüfverfahren.

Bemessungsspannung

Spezifiziert den maximalen Wert der elektrischen Spannung im Normalbetrieb. Die Angaben der Betriebseigenschaften des Steckverbinders sind auf die Bemessungsspannung bezogen.

Isolationswiderstand

Gemäß IEC 60512-2, 3a und DIN EN 60512-2 wird das Isoliervermögen eines Werkstoffes beschrieben, der benachbarte Kontakte oder einen Kontakt gegen Masse möglichst hochohmig trennt.

Strombelastbarkeit

Die Strombelastbarkeit eines Steckverbinders gemäß DIN ISO 60512-3 definiert den Maximalstrom, der – bei einer Umgebungstemperatur von 40°C – dauerhaft über alle Kontakte gleichzeitig fließen darf. Die Summe aus strombedingter Eigenerwärmung der Kontakte und Umgebungstemperatur darf die maximale Grenztemperatur eines Steckverbinders – definiert durch die thermischen Eigenschaften der verwendeten Materialien – nicht überschreiten. Die sogenannte Derating-Kurve (Abb.1) stellt den Zusammenhang zwischen Strombelastbarkeit eines Steckverbinders und dessen Umgebungstemperatur dar. In der Praxis sind u. U. höhere Ströme je Kontakt zulässig, da nicht alle Kontakte gleichzeitig, dauerhaft maximal bestromt werden. Die genauen Werte sind im Einzelfall durch Tests zu ermitteln.

Isolationskoordination (Luft- und Kriechstrecken)

Für elektrische Betriebsmittel in Niederspannungsanlagen (< 1kV) beschreibt die DIN EN 60664 (DIN VDE 0110) das Verfahren zur Bemessung der isolierenden Luft- und Kriechstrecken (Abb.2). Sie definiert Mindestluftstrecken (minimale Entfernung zwischen spannungsführenden Teilen in Luft) und Mindestkriechstrecken (minimale Entfernung zwischen spannungsführenden Teilen entlang einer isolierenden Oberfläche) zur Vermeidung eines elektrischen Überschlags. Mindestkriechstrecken sind abhängig von Isolierstoff und Verschmutzungsgrad.

Verschmutzungsgrad

Der Verschmutzungsgrad (Wert 1-4) gibt die Quantität der Verschmutzung (feste, flüssige oder gasförmige Fremdkörper) an, bei der Durchschlagfestigkeit und/oder Oberflächenwiderstand gemindert werden. Für industrielle Anwendungen ist ein Verschmutzungsgrad 3 typisch: Leitfähige oder trockene, nichtleitfähige Verschmutzung tritt auf. Letztere kann durch zu erwartende Betauung leitfähig werden.

Mechanische Lebensdauer

Gibt die Anzahl der Steckzyklen an (ein mechanischer Steck- und Ziehvorgang eines Steckverbinders), bei denen es nicht zum Abrieb der Kontaktflächen und damit zur Erhöhung des Kontaktwiderstandes kommt.



Abb 1. Derating-Kurve



Abb 2. Isolationskoordination

AWG	Leiteraufbau [mm]	Leiterdurchmesser [mm]	Leiterquerschnitt [mm ²]
30	1 x 0,25 7 x 0,10	0,25 0,36	0,05 0,06
28	1 x 0,32 7 x 0,13	0,32 0,38	0,08 0,09
26	1 x 0,4 7 x 1,16 19 x 0,10	0,40 0,48 0,51	0,13 0,14 0,15
24	1 x 0,51 17 x 0,20 19 x 0,13	0,51 0,61 0,64	0,21 0,22 0,25
22	1 x 0,64 7 x 0,25 19 x 0,16	0,64 0,76 0,81	0,33 0,34 0,38
20	1 x 0,81 7 x 0,32 19 x 0,20	0,81 0,97 1,02	0,52 0,56 0,60
18	1 x 1,02 19 x 0,25	1,02 1,27	0,82 0,93
16	19 x 0,29	1,44	1,25
14	19 x 0,36	1,80	1,93
12	19 x 0,46	2,29	3,16
10	37 x 0,40	3,10	4,65

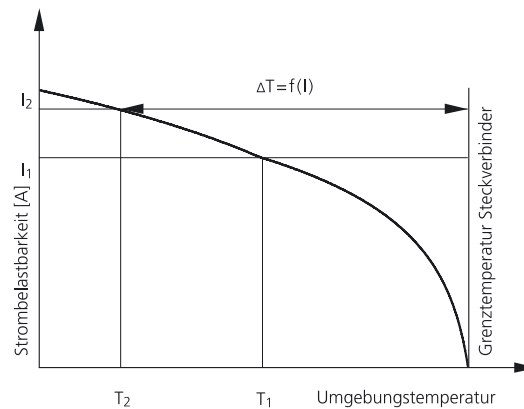
Umrechnung Amerikanische Leiterbezeichnungen, AWG in mm²

In einigen Industriebereichen wird mit Leitern nach der amerikanischen Drahtlehre AWG (American Wire Gauge) gearbeitet. Die folgende Tabelle dient der Umrechnung von AWG in mm². Zu beachten ist, dass Leiter mit gleicher AWG-Nummer, aber unterschiedlichem Aufbau, leicht unterschiedliche Querschnitte aufweisen!

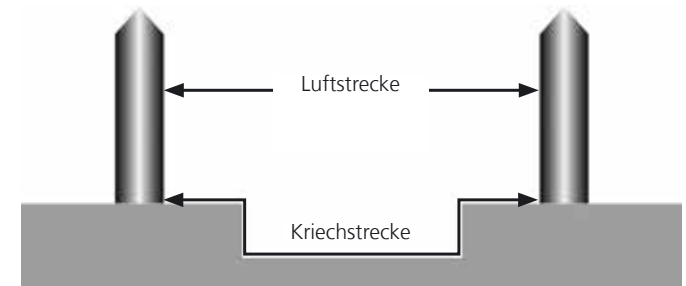
Pg	metrisches Gewinde	max. Schlüsselweite [mm]	max. Eckmaß [mm]
Pg7	M10x1,5 M12x1,5	16	18
Pg9 Pg11	M16x1,5	21	23
Pg13,5	M20x1,5	25	28

Übersicht Pg-Gewinde zu metrischem Gewinde (Schlüsselweiten für Kabelverschraubungen nach EN 50262)

Am 31.12.1999 endete die Übergangsfrist der DIN 46320 „Verschraubungen für Kabel und Leitungen mit Pg-Gewinden“. Verschraubungen für Kabel und Leitungen mussten seitdem zunächst der nationalen Norm 46319 entsprechen, ehe diese dann am 01.03.2001 durch die EN 50262 abgelöst wurde.

ZULASSUNGEN | ZERTIFIZIERUNGEN

UL (Underwriter Laboratories Inc.)

Die Zertifizierung von Produkten, Komponenten oder Materialien durch die Underwriter Laboratories Inc. bedeutet den geprüften Nachweis, dass diese spezifischen Sicherheitsanforderungen genügen. UL-Zulassungen bedarf es vor allem für den amerikanischen und kanadischen Markt.

Für entsprechende ESCHA Produkte gelten Komponentenzulassungen (UL Recognized Component), die sie als UL-zugelassene Komponenten zum Einbau in UL-zugelassene Systeme kennzeichnen. Diese Komponentenzulassung gilt auch für entsprechend verwendete Leitungsqualitäten. Einzelne Leitungsqualitäten (siehe Tabelle Standard-Leitungsqualitäten) tragen das UL-Listing-Prüfzeichen (sog. Gerätezulassung), welches die Übereinstimmung mit den geltenden UL-Sicherheitsanforderungen garantiert.

ECOLAB

Das Unternehmen ECOLAB bietet spezielle Reinigungs- und Desinfektionsmittel für die Lebensmittelverarbeitende Industrie an. In der Vergangenheit wurden von dem Unternehmen ECOLAB Beständigkeitstests für Komponentenhersteller angeboten. Mittlerweile werden den Komponentenlieferanten Reinigungsmittel für eigene Tests zur Verfügung gestellt. ESCHA testet nach den Vorgaben von ECOLAB in gleicher Art und Weise heute im eigenen Testlabor.





Schirmung | ESCHA 2-Schalen-Schirmkonzept (ESCHA 2SSK)

FDA

Die Food and Drug Administration (FDA) ist eine staatliche, US-amerikanische Behörde, die für die Lebensmittelüberwachung und Arzneimittelzulassungen zuständig ist. Sie definiert Materialien für die Lebensmittelherstellung, von denen keine Wechselwirkungen im Verarbeitungsprozess ausgehen. ESCHA verwendet für seine Produktlinie im Hygienic Design ausschließlich FDA zugelassene Materialien.

Richtlinie 2011/65/EU (RoHS - Restriction of [the use of certain] Hazardous Substances)

Die EU-Richtlinie zur Beschränkung der Verwendung bestimmter gefährlicher Stoffe in Elektro- und Elektronikgeräten verbietet Gefahrstoffe in Geräten und Bauteilen oberhalb festgelegter Grenzwerte. Dazu gehören Blei, Cadmium, Quecksilber, sechswertiges Chrom, Polybromierte Biphenyle (PBB), und Polybromierte Diphenylether (PBDE). Für ESCHA Produkte bedeutet das bleifreie Verlöten und keine Verwendung giftiger Flammschutzmittel in Kunststoffen und Kabeln.

Richtlinie SJ/T 11364-2014 (China RoHS Standard)

Für ESCHA Artikel wird die Einhaltung der Richtlinie mit dem EUP-Label (Environmentally friendly Use Period) ausgewiesen. Zulässige Restbestände gefährlicher Substanzen im Sinne der RoHS Richtlinie sind im Produkt derart chemisch gebunden, dass sie in einem Zeitraum von 50 Jahren (Zahl im EUP-Label) unter normalen Umgebungsbedingungen nicht austreten.

GOST-R (ГОСТ - Государственный Стандарт)

Für die Einfuhr von Waren in die Russische Föderation bedarf es der Zertifizierung durch die Föderale Agentur für technische Regulierung und Metrologie. Diese prüft die Übereinstimmung der Produkte mit russischen Anforderungen, Normen und Qualitätsstandards.

CE-Kennzeichnung

Die CE Kennzeichnung eines Produktes zeigt an, dass ein Produkt von einer harmonisierenden EU-Richtlinie erfasst wird und die dort festgelegten Anforderungen erfüllt.

Seit dem Erscheinen des Gesetzes über die elektromagnetische Verträglichkeit von Geräten wird der Schirmung mehr Bedeutung beigemessen. Die Geräte müssen so beschaffen sein, dass:

- Die Erzeugung elektromagnetischer Störungen soweit begrenzt wird, dass ein bestimmungsgemäßer Betrieb dieser Geräte möglich ist.
- Die Geräte eine angemessene Festigkeit gegen elektromagnetische Störungen aufweisen, so dass ein bestimmungsgemäßer Betrieb möglich ist.

Das ESCHA 2-Schalen-Schirmkonzept besteht in der Bildung einer Äquipotentialfläche durch zwei miteinander verbundenen Metallschalen, die den Steckverbinder 360° kapseln. Das Schirmgeflecht der angespritzten Leitung ist umlaufend auf die Schirmhülsen gecrimpt. Eine Zweifach-Umspritzung sichert die 360°-Schirmung auch bei hoher mechanischer Beanspruchung, staub- und wasserdicht auch bei Hochdruck- und Dampfstrahlreinigung gemäß IP67 und IP69.

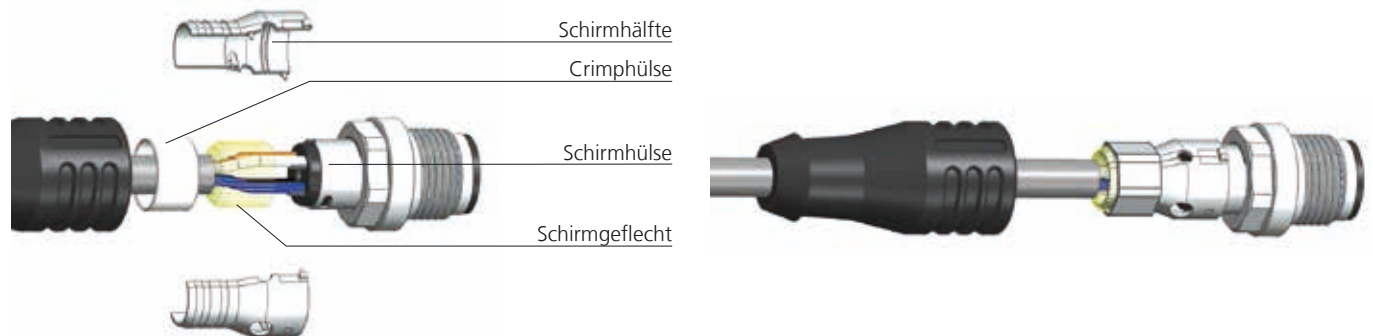

Die Voraussetzung für die vom Hersteller zugesicherten Eigenschaften hinsichtlich einer entsprechend dichten und zuverlässigen elektrischen Verbindung sind die richtige Montage der Steckverbinder und eine sachgemäße Verlegung der Leitungen. Um Beschädigungen an Steckverbinder und Leitung zu vermeiden, ist bei der Verlegung der minimale Biegeradius (r_{min}) der Leitung zu beachten.

Datenleitungen sind Hochleistungsprodukte. Um eine dauerhafte, sichere Datenübertragung zu gewährleisten sind jegliche mechanische Einflüsse wie Quetschen, scharfkantiges Abknicken, Zugkräfte etc. während der Montage und im Betrieb zu vermeiden. Eine Montage bei Minustemperaturen bedarf besonderer Sorgfalt, da Kunststoffe bei niedriger Temperatur andere Eigenschaften aufweisen und es zu Beschädigungen des Endproduktes kommen kann. Bei der Verwendung von Kabelbindern zur Leitungsbündelung oder Festverlegung, dürfen diese nicht in die Leitung einschneiden oder diese deformieren, um Kurzschlüsse, Leitungsunterbrechungen oder eine Verringerung der Spannungsfestigkeit zu vermeiden.

Bei Verbindungsleitungen sollte auf ausreichende Leitungslänge zwischen den Anschlüssen geachtet werden, um die zugeführte Energie bei Bewegung zu absorbieren. Die Verwendung von Kabelschlaufen, Spiralleitungen oder Energieführungsketten garantiert eine höhere Lebensdauer des Steckverbindersystems.

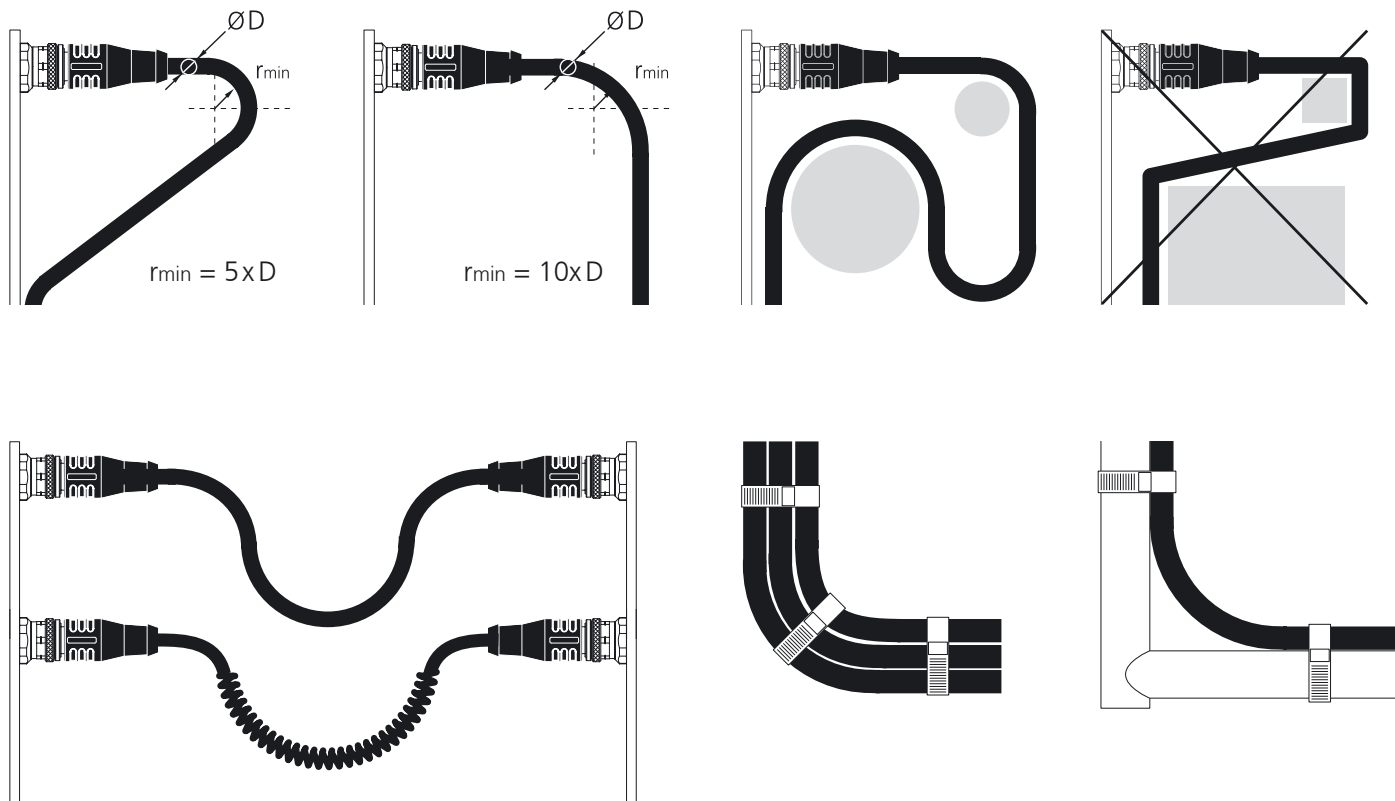

Anzugsdrehmomente

Zum Festziehen und Lösen von Rundsteckverbindern wird die Verwendung eines Drehmoment-Schraubwerkzeuges empfohlen. Die Empfehlungen sind auf der Basis interner Tests festgelegt worden und decken einen Großteil der Applikationen und Produktkombinationen ab. Aufgrund der konstruktiven Vielzahl am Markt erhältlicher Steckverbinder sind im Einzelfall die Angaben zu überprüfen.

Empfohlene Anzugs-/Einschraubdrehmomente unter Typprüfbedingungen nach IEC 61076-2

Rundsteckverbinder	M12x1	1,0Nm
	M8x1	0,6Nm
Flansche	M12x1	2,0Nm
	M8x1	1,5Nm
Ventilstecker	VA	1,0Nm
	VB VBI	1,0Nm
	VC VCI	0,6Nm

Kontaktbelegung M12x1 | A

Sensor/Aktor: BL | AL | FB | HT



Polzahl	Codierung	Pin												
		1	2	3	4	5	6	7	8	9	10	11	12	
3	A	BN		BU	BK									
4	A	BN	WH	BU	BK									
4+PE	A	BN	WH	BU	BK	GN/YE								
5	A	BN	WH	BU	BK	GY								
8	A	WH	BN	GN	YE	GY	PK	BU	RD					
12	A	BN	BU	WH	GN	PK	YE	BK	GY	RD	VT	GY/PK	RD/BU	

Kontaktbelegung M8x1/Ø8mm snap

Sensor/Aktor: BL | AL | FB | HT



Polzahl		Pin												
		1	2	3	4	5								
3		BN		BU	BK									
4		BN	WH	BU	BK									
5		BN	WH	BU	BK	GY								

Kontaktbelegung M12x1 POWER
PS | PT | PK | PL

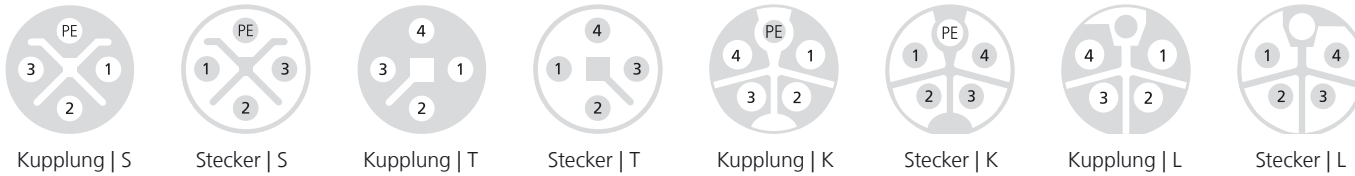

		Pin									
Polzahl	Codierung	Belegung	1	2	3	4	5				
2+PE	S	3.002	BN		BU	GN/YE					
2+PE	S	3.031	BK		BK	GN/YE					
3+PE	S	4.155	BN	BK	GY	GN/YE					
3+PE	S	4.165	BK	BK	BK	GN/YE					
4	T		BN	WH	BU	BK					
4+PE	K	5.244	BK	BN	GY	BU	GN/YE				
4	L	4	BN	WH	BU	BK					

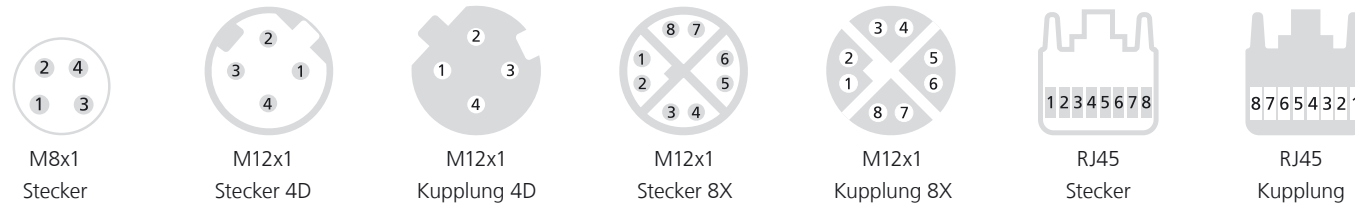

Kontaktbelegung Industrial Ethernet

			Pin								
Bauform	Polzahl	Codierung	Belegung	1	2	3	4	5	6	7	8
M8x1	4		4.027	WH/OG	WH/BU	BU	OG				
M12x1	4	D	4.029	YE	WH	OG	BU				
M12x1	4	D	4.082	WH/OG	WH/BU	OG	BU				
M12x1	8	X	8.066	WH(OG)	OG	WH(GN)	GN	WH(BN)	BN	WH(BU)	BU
RJ45	4		4.003	YE	OG	WH			BU		
RJ45	4		8.005	WH(OG)	OG	WH(BU)			BU		
RJ45	8		8.002	WH(OG)	OG	WH(GN)	BU	WH(BU)	GN	WH(BN)	BN

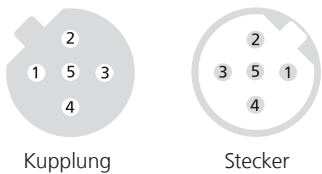

Kontaktbelegung Profibus

			Pin								
Bauform	Polzahl	Codierung	Belegung	1	2	3	4	5			
M12x1	5	B	2.012		GN		RD				

Kontaktbelegung CANopen/DeviceNet



Kupplung

Stecker

Bauform	Polzahl	Codierung	Belegung	Pin							
				1	2	3	4	5			
M12x1	4+GND	A	5.022		RD	BK	WH	BU			
				GND	+	-	CAN_H	CAN_L			

Kontaktbelegung Ventilstecker

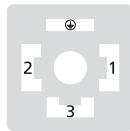

VA21

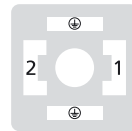

VA22

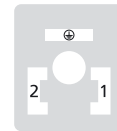

VB21

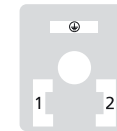

VBI22

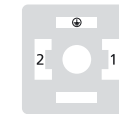

VC21

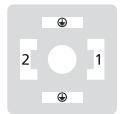

VC22

Bauform	Belegung		Pin							
			1	2	3 PE	PE				
A	21	2 Kontakte + PE	BN	BU		GN/YE				
A	22	2 Kontakte + PE gebrückt	BN	BU		GN/YE				
A	41	3 Kontakte + PE + Litzenanschluss	BN	WH	BK	GN/YE				
B BI	21	2 Kontakte + PE	BN	BU		GN/YE				
C CI	21	2 Kontakte + PE	BN	BU		GN/YE				
C CI	22	2 Kontakte + PE gebrückt	BN	BU		GN/YE				

Kontaktbelegung M23x1

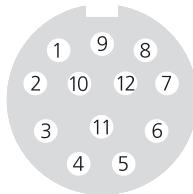

Kupplung

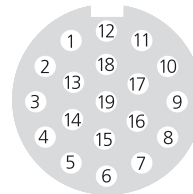

Stecker

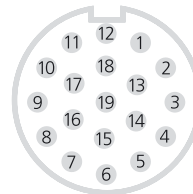
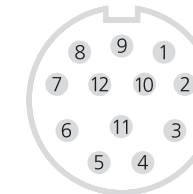

	Pin																		
	1	2	3	4	5	6	7	8	9	10	11	12	13	14	15	16	17	18	19
12.001	WH	GN	YE	GY						BU	BN	GN/YE							
12.003	WH	GN	YE	GY	PK	RD	BK	VT		BU	BN	GN/YE							
19.001			GY	RD/BU	GN	BU	GY/PK					WH/GN		BN/GN	WH	YE			BN
19.003	VT	RD	GY	RD/BU	GN	BU	GY/PK	WH/GN	WH/YE	WH/GY	BK	GN/YE	YE/BN	BN/GN	WH	YE	PK	GY/BN	BN

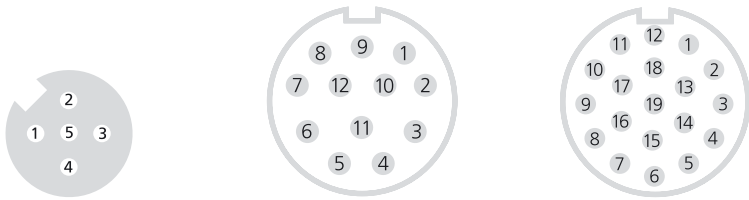

M12x1, Kupplung

M23x1, Stecker

M12x1																			
I/O	1		2		3		4		5		6		7		8		alle	alle	alle
I/O_Pin	2	4	2	4	2	4	2	4	2	4	2	4	2	4	2	4	1	3	5
M23_12-polig	-	1	-	2	-	3	-	4	-	5	-	6	-	7	-	8	11	9+10	12
M23_19-polig	7	15	4	5	8	16	14	3	9	17	13	2	10	11	18	1	19	6	12
Festkabel	GY/PK	WH	RD/BU	GN	WH/GN	YE	BN/GN	GY	WH/YE	PK	YE/BN	RD	WH/GY	BK	GY/BN	VT	BN (+)	BU (-)	GN/YE



M8x1/Ø8mm snap, Kupplung

M12x1, Stecker

M8x1/Ø8mm snap																				
I/O	1		2		3		4		5		6		7		8		9	10	alle	
I/O_Pin	4	2	4	2	4	2	4	2	4	2	4	2	4	2	4	2	4	4	1	3
M12_12-polig (I/O 3-polig)	3	-	4	-	6	-	8	-	5	-	9	-	7	-	10	-	11	12	1	2
M12_12-polig (I/O 4-polig)	3	5	4	9	6	7	8	10	-	-	-	-	-	-	-	-	11	12	1	2
M12_8 pin	1	-	2	-	3	-	4	-	-	-	-	-	-	-	-	-	-	-	5	7
Festkabel	WH	GY/PK	GN	RD/BU	YE	WH/GN	GY	BN/GN	PK	WH/YE	RD	YE/BN	BK	WH/GY	VT	GY/BN	WH/PK	BN/PK	BN (+)	BU (-)

			
	AR AUMECON S.A. Acassuso 4768, 1605 Munro/Buenos Aires	+54 11 47561251	aumecon.com.ar
	AT ESCHA GmbH & Co. KG Office Austria	+43 664 3072340	escha.net
	AU Colterlec Pty Ltd Unit 2, 106 Beaconsfield Street, Silverwater NSW 2128	+61 1300 656 090	colterlec.com.au
	BA Tipteh d.o.o. Sarajevo Ulica Branilaca Sipa 21c, 71000 Sarajevo	+387 61 923623	tipteh.ba
	BE forTop automation & energy control bvba Guido Gezellestraat 126, GG126 Business Center 0.10, 1654 Huizingen	+32 2 3314116	fortop.be
	CH Omni Ray AG Im Schörl 5, 8600 Dübendorf	+41 44 802 28 80	omniray.ch
	CN ESCHA Automation Connectivity (Shanghai) Co., Ltd. 1F South Building, 168 Huancheng Bei Road, Fengpu Industrial Park Fengxian District 201401 Shanghai	+86 21 52968180	escha.net
	DE ESCHA GmbH & Co. KG Elberfelder Str.32, 58553 Halver	+49 2353 708-800	escha.net
	DK Hans Følsgaard AVS Theilgaards Torv 1, 4600 Køge	+45 43 208600	hf.net
	ES ELION S.A. Farell, 5, 08014 Barcelona	+34 9 32982000	elion.es
	FI SARLIN Oy Ab Kaivokselantie 3-5, 01610 Vantaa	+358 10550 4000	sarlin.com
	HR Tipteh Zagreb d.o.o. Ratarska 35, 10000 Zagreb	+385 1 314 1550	tipteh.hr
	IE forTop automation & energy control UK LTD Malvern Hills Science Park, Geraldine Road Malvern, Worcestershire WR14 3SZ UK	+44 1684 585148	fortop.co.uk
	IN Automation Combine B.R. House, 2nd Floor Hennur Main Road, Bangalore 560043	+91 80 2543 5757	automationcombine.in
	IT TKD ITALIA S.R.L. Via Matteotti 37, 40064 Ozzano Dell' Emilia (BO)	+39 051 790 636	tkditalia.it
	MK Tipteh d.o.o. Skopje Ul. Bul.Partizanski Odredi 80 lok 5, 1000 Skopje	+389 2 31 74 197	tipteh.mk
	NL forTop automation & energy control bv Grote Kranerweerd 53, 8064 PE Zwartsluis	+31 38- 337 27 00	fortop.nl
	NO HF DANYKO AS Bark Silas Vei 8, 4876 Grimstad	+47 37 090 940	danyko.no
	PL ESCHA GmbH & Co. KG Office Poland	+48 608 69 07 05	escha.net
	PT BRESIMAR Automacao, S.A. Quinta do Simao EN109 - Esgueira Apartado 3080 3801-101 Aveiro	+351 234 303 320	bresimar.pt
	RS Tipteh d.o.o. Beograd Toplice Milana 14A, 1050 Beograd	+381 11 28 92 250	tipteh.rs
	SE TUFVASSONS AB Märstavägen 20, 193 40 Sigtuna	+46 8-594 809 00	tufvassons.se
	SI Tipteh d.o.o. Ulica Ivana Roba 21, 1000 Ljubljana	+386 1 200 51 50	tipteh.si
	SK MARPEX s.r.o. Sportovcov 672, 01841 Dubnica nad Váhom	+421 42 4426986-87	marpex.sk
	TR Gökhan Elektrik Malzemeleri Sanayi ve Ticaret LTD STI. Perpa Elektrokent is Merkezi A Blok K.8 No.692-694, 34385 Okmeydani /Istanbul	+90 2122213236	gokhanelektrik.com.tr
	UK forTop automation & energy control UK LTD Malvern Hills Science Park, Geraldine Road Malvern, Worcestershire WR14 3SZ UK	+44 1684 585148	fortop.co.uk